

P-2000W_V2

VoIP Wi-Fi Phone

User's Guide

Version WV.00.01
6/2005

The logo for ZyXEL, featuring the word "ZyXEL" in a bold, blue, sans-serif font. The "Zy" is in a lighter blue, and "XEL" is in a darker blue. The letters are slightly italicized.

Copyright

Copyright © 2005 by ZyXEL Communications Corporation.

The contents of this publication may not be reproduced in any part or as a whole, transcribed, stored in a retrieval system, translated into any language, or transmitted in any form or by any means, electronic, mechanical, magnetic, optical, chemical, photocopying, manual, or otherwise, without the prior written permission of ZyXEL Communications Corporation.

Published by ZyXEL Communications Corporation. All rights reserved.

Disclaimer

ZyXEL does not assume any liability arising out of the application or use of any products, or software described herein. Neither does it convey any license under its patent rights nor the patent rights of others. ZyXEL further reserves the right to make changes in any products described herein without notice. This publication is subject to change without notice.

Trademarks

ZyNOS (ZyXEL Network Operating System) is a registered trademark of ZyXEL Communications, Inc. Other trademarks mentioned in this publication are used for identification purposes only and may be properties of their respective owners.

Federal Communications Commission (FCC) Interference Statement

This device complies with Part 15 of FCC rules. Operation is subject to the following two conditions:

- This device may not cause harmful interference.
- This device must accept any interference received, including interference that may cause undesired operations.

This equipment has been tested and found to comply with the limits for a Class B digital device pursuant to Part 15 of the FCC Rules. These limits are designed to provide reasonable protection against harmful interference in a commercial environment. This equipment generates, uses, and can radiate radio frequency energy, and if not installed and used in accordance with the instructions, may cause harmful interference to radio communications.

If this equipment does cause harmful interference to radio/television reception, which can be determined by turning the equipment off and on, the user is encouraged to try to correct the interference by one or more of the following measures:

- Reorient or relocate the receiving antenna.
- Increase the separation between the equipment and the receiver.
- Connect the equipment into an outlet on a circuit different from that to which the receiver is connected.
- Consult the dealer or an experienced radio/TV technician for help.

Notice 1

Changes or modifications not expressly approved by the party responsible for compliance could void the user's authority to operate the equipment.

This Class B digital apparatus complies with Canadian ICES-003.

Cet appareil numérique de la classe B est conforme à la norme NMB-003 du Canada.

Certifications

Go to www.zyxel.com

- 1 Select your product from the drop-down list box on the ZyXEL home page to go to that product's page.
- 2 Select the certification you wish to view from this page.



Safety Warnings

For your safety, be sure to read and follow all warning notices and instructions.

- Do NOT open the device or unit. Opening or removing covers can expose you to dangerous high voltage points or other risks. ONLY qualified service personnel can service the device. Please contact your vendor for further information.
- Use ONLY the dedicated power supply for your device. Connect the power cord or power adaptor to the right supply voltage (110V AC in North America or 230V AC in Europe).
- Do NOT use the device if the power supply is damaged as it might cause electrocution.
- If the power supply is damaged, remove it from the power outlet.
- Do NOT attempt to repair the power supply. Contact your local vendor to order a new power supply.
- Place cables carefully so that no one will step on them or stumble over them. Do NOT allow anything to rest on the power cord and do NOT locate the product where anyone can walk on the power cord.
- Do NOT install nor use your device during a thunderstorm. There may be a remote risk of electric shock from lightning.
- Do NOT expose your device to dampness, dust or corrosive liquids.
- Do NOT use this product near water, for example, in a wet basement or near a swimming pool.
- Do NOT obstruct the device ventilation slots, as insufficient airflow may harm your device.
- Do NOT store things on the device.
- Connect ONLY suitable accessories to the device.

ZyXEL Limited Warranty

ZyXEL warrants to the original end user (purchaser) that this product is free from any defects in materials or workmanship for a period of up to two years from the date of purchase. During the warranty period, and upon proof of purchase, should the product have indications of failure due to faulty workmanship and/or materials, ZyXEL will, at its discretion, repair or replace the defective products or components without charge for either parts or labor, and to whatever extent it shall deem necessary to restore the product or components to proper operating condition. Any replacement will consist of a new or re-manufactured functionally equivalent product of equal value, and will be solely at the discretion of ZyXEL. This warranty shall not apply if the product is modified, misused, tampered with, damaged by an act of God, or subjected to abnormal working conditions.

Note

Repair or replacement, as provided under this warranty, is the exclusive remedy of the purchaser. This warranty is in lieu of all other warranties, express or implied, including any implied warranty of merchantability or fitness for a particular use or purpose. ZyXEL shall in no event be held liable for indirect or consequential damages of any kind of character to the purchaser.

To obtain the services of this warranty, contact ZyXEL's Service Center for your Return Material Authorization number (RMA). Products must be returned Postage Prepaid. It is recommended that the unit be insured when shipped. Any returned products without proof of purchase or those with an out-dated warranty will be repaired or replaced (at the discretion of ZyXEL) and the customer will be billed for parts and labor. All repaired or replaced products will be shipped by ZyXEL to the corresponding return address, Postage Paid. This warranty gives you specific legal rights, and you may also have other rights that vary from country to country.

Customer Support

Please have the following information ready when you contact customer support.

- Product model and serial number.
- Warranty Information.
- Date that you received your device.
- Brief description of the problem and the steps you took to solve it.

METHOD	SUPPORT E-MAIL	TELEPHONE ^A	WEB SITE	REGULAR MAIL
LOCATION	SALES E-MAIL	FAX	FTP SITE	
CORPORATE HEADQUARTERS (WORLDWIDE)	support@zyxel.com.tw	+886-3-578-3942	www.zyxel.com www.europe.zyxel.com	ZyXEL Communications Corp. 6 Innovation Road II Science Park Hsinchu 300 Taiwan
	sales@zyxel.com.tw	+886-3-578-2439	ftp.zyxel.com ftp.europe.zyxel.com	
CZECH REPUBLIC	info@cz.zyxel.com	+420 241 091 350	www.zyxel.cz	ZyXEL Communications Czech s.r.o. Modranská 621 143 01 Praha 4 - Modrany Ceská Republika
	info@cz.zyxel.com	+420 241 091 359		
DENMARK	support@zyxel.dk	+45 39 55 07 00	www.zyxel.dk	ZyXEL Communications A/S Columbusvej 5 2860 Soeborg Denmark
	sales@zyxel.dk	+45 39 55 07 07		
FINLAND	support@zyxel.fi	+358-9-4780-8411	www.zyxel.fi	ZyXEL Communications Oy Malminkaari 10 00700 Helsinki Finland
	sales@zyxel.fi	+358-9-4780 8448		
FRANCE	info@zyxel.fr	+33 (0)4 72 52 97 97	www.zyxel.fr	ZyXEL France 1 rue des Vergers Bat. 1 / C 69760 Limonest France
		+33 (0)4 72 52 19 20		
GERMANY	support@zyxel.de	+49-2405-6909-0	www.zyxel.de	ZyXEL Deutschland GmbH. Adenauerstr. 20/A2 D-52146 Wuerselen Germany
	sales@zyxel.de	+49-2405-6909-99		
NORTH AMERICA	support@zyxel.com	+1-800-255-4101 +1-714-632-0882	www.us.zyxel.com	ZyXEL Communications Inc. 1130 N. Miller St. Anaheim CA 92806-2001 U.S.A.
	sales@zyxel.com	+1-714-632-0858	ftp.us.zyxel.com	
NORWAY	support@zyxel.no	+47 22 80 61 80	www.zyxel.no	ZyXEL Communications A/S Niils Hansens vei 13 0667 Oslo Norway
	sales@zyxel.no	+47 22 80 61 81		
SPAIN	support@zyxel.es	+34 902 195 420	www.zyxel.es	ZyXEL Communications Alejandro Villegas 33 1º, 28043 Madrid Spain
	sales@zyxel.es	+34 913 005 345		
SWEDEN	support@zyxel.se	+46 31 744 7700	www.zyxel.se	ZyXEL Communications A/S Sjöporten 4, 41764 Göteborg Sweden
	sales@zyxel.se	+46 31 744 7701		

METHOD	SUPPORT E-MAIL	TELEPHONE^A	WEB SITE	REGULAR MAIL
LOCATION	SALES E-MAIL	FAX	FTP SITE	
UNITED KINGDOM	support@zyxel.co.uk	+44 (0) 1344 303044 08707 555779 (UK only)	www.zyxel.co.uk	ZyXEL Communications UK Ltd.,11 The Courtyard, Eastern Road, Bracknell, Berkshire, RG12 2XB, United Kingdom (UK)
	sales@zyxel.co.uk	+44 (0) 1344 303034	ftp.zyxel.co.uk	

a. "+" is the (prefix) number you enter to make an international telephone call.

Table of Contents

Copyright	3
Federal Communications Commission (FCC) Interference Statement	4
Safety Warnings	6
ZyXEL Limited Warranty	7
Customer Support	8
Table of Contents	11
List of Figures	17
List of Tables	19
Preface	21
Chapter 1	
Getting To Know Your Prestige	23
1.1 Features	23
1.2 Applications	24
1.2.1 Place a Call via “SIP Proxy Server” (SIP Call Server)	24
1.2.2 Direct IP to IP Calling	25
1.2.3 Ad-Hoc (Wireless Intercom)	25
1.3 Getting to Know the Prestige Hardware	26
Chapter 2	
Using the LCD Screen Menus	29
2.1 LCD Main Screen	29
2.2 Navigating the LCD Screen Menus	30
2.2.1 Text Input	30
Chapter 3	
Wireless LAN Setup Menus	33
3.1 Site Survey	33
3.2 SSID	34
3.3 Network Mode	34
3.4 Channel	35
3.5 Rate	36
3.6 WEP Encryption	36

3.7 Authentication Type	37
3.8 Profiles	38
Chapter 4	
Network Settings	41
4.1 Fixed IP	41
4.2 DHCP	42
4.3 PPPoE	43
Chapter 5	
SIP Settings	45
5.1 Registrar Server	45
5.2 Outbound Proxy Server	46
5.3 Proxy Server	47
5.4 User Account	48
Chapter 6	
Phonebook	51
6.1 Calling Methods	51
6.2 Adding a Phonebook Entry	51
6.3 Editing Phonebook Entries	52
6.4 Erasing Phonebook Entries	53
6.5 Speed Dial Phonebook Entries	54
Chapter 7	
Call History	55
7.1 Missed Calls	55
7.2 Received Calls	56
7.3 Dialed Calls	57
7.4 Erasing Calls	57
Chapter 8	
Miscellaneous Settings	59
8.1 Setting the Ring Melody	59
8.2 Setting the Vibration Mode	60
8.3 Adjusting the Ring Volume	60
8.4 Setting the Time	61
8.5 Setting the Date	61
8.6 Setting the Banner	62
8.7 Setting the Key Lock	62
8.8 Setting the Don't Disturb	63

Chapter 9	
Information Menus	65
9.1 Displaying Information	65
Chapter 10	
Prestige Usage	67
10.1 Dialing a Telephone Number	67
10.2 Using the Phonebook to Dial a Telephone Number	67
10.3 Using Speed Dial to Dial a Telephone Number	67
10.4 Redialing a Telephone Number	67
10.5 Answering a Call	68
10.6 Rejecting a Call	68
10.7 Changing the Volume	68
Chapter 11	
Using the Web Configurator Screens.....	69
11.1 Introduction to the Web Configurator	69
11.2 Accounts	69
11.2.1 Login	69
11.3 Navigating the Prestige Web Configurator	70
Chapter 12	
User Web Configurator Screens.....	73
12.1 Device Information	73
12.2 IP Address Assignment	73
12.3 IP Address and Subnet Mask	74
12.4 MAC Address	74
12.5 DNS Server	75
12.6 Network Configuration: STATIC	75
12.7 Network Configuration: DHCP	76
12.8 Network Configuration: PPPoE	78
12.9 VoIP Introduction	79
12.9.1 SIP	79
12.9.1.1 SIP Identities	79
12.9.1.2 SIP Call Progression	80
12.9.1.3 SIP Client Server	80
12.9.1.4 RTP	82
12.10 SIP Configuration	82
12.11 NAT	83
12.11.1 NAT Example	84
12.11.2 NAT Types	84
12.11.2.1 Full Cone NAT	85
12.11.2.2 Restricted Cone NAT	86

12.11.2.3 Port Restricted Cone NAT	87
12.11.2.4 Symmetric NAT	87
12.12 NAT and SIP	88
12.12.1 SIP ALG	88
12.12.2 Fake WAN Address on SIP and RTP	88
12.12.3 STUN	89
12.12.4 Outbound Proxy	89
12.13 NAT Traversal Configuration	89
12.14 Phonebook	91
12.14.1 Calling Methods	91
12.15 Phonebook Configuration	91
12.16 Wireless Introduction	93
12.16.1 WEP Encryption	93
12.17 Wireless Settings	93
12.18 System	95
12.19 S/W Update	95
Chapter 13	
Administrator Web Configurator Screens	97
13.1 NAT Traversal Configuration	97
13.2 SIP Proxy Configuration	98
13.3 Voice Coding	100
13.3.1 G.711	100
13.3.2 G.729	101
13.4 PSTN Call Setup Signaling	101
13.5 Phone Setting	101
13.6 System	103
13.7 Quality of Service	103
13.8 ToS	104
13.9 Introduction to DiffServ	104
Chapter 14	
Troubleshooting	105
14.1 Problems Starting Up the Prestige	105
14.2 Problems Using the Keypad	105
14.3 Problems Accessing the Prestige	106
14.4 Warning Message Troubleshooting	106
14.5 Error Message Troubleshooting	107
14.6 Restoring the Factory Default Settings	107
Appendix A	
Product Specifications	109
Appendix B	

IP Subnetting	111
IP Addressing	111
IP Classes	111
Subnet Masks	112
Subnetting	112
Example: Two Subnets	113
Example: Four Subnets	115
Example Eight Subnets	116
Subnetting With Class A and Class B Networks	117
Appendix C	
PPPoE	119
PPPoE in Action	119
Benefits of PPPoE	119
Traditional Dial-up Scenario	119
How PPPoE Works	120
Prestige as a PPPoE Client	120
Appendix D	
Wireless LANs	121
Wireless LAN Topologies	121
Ad-hoc Wireless LAN Configuration	121
BSS	121
ESS	122
Channel	123
Roaming	123
Requirements for Roaming	124
Index	127

List of Figures

Figure 1 SIP Proxy Server Application	25
Figure 2 IP to IP Calling	25
Figure 3 Ad-Hoc Mode	26
Figure 4 Prestige Hardware	26
Figure 5 LCD Main Screen	29
Figure 6 LCD Screen Menu Navigation	30
Figure 7 Text Input	30
Figure 8 Browser Address	69
Figure 9 Login Screen	70
Figure 10 Web Configurator First User Screen	70
Figure 11 Web Configurator First Administrator Screen	71
Figure 12 Device Information	73
Figure 13 STATIC Network Configuration	75
Figure 14 DHCP Network Configuration	77
Figure 15 PPPoE Network Configuration	78
Figure 16 SIP User Agent	81
Figure 17 SIP Proxy Server	81
Figure 18 SIP Redirect Server	82
Figure 19 SIP	83
Figure 20 NAT: Outgoing	84
Figure 21 NAT: Incoming	84
Figure 22 Full Cone NAT Example	86
Figure 23 Restricted Cone NAT Example	86
Figure 24 Port Restricted Cone NAT Example	87
Figure 25 Symmetric NAT	88
Figure 26 STUN	89
Figure 27 NAT Traversal Configuration	90
Figure 28 Phonebook	92
Figure 29 Wireless Setting	94
Figure 30 System	95
Figure 31 S/W Update	96
Figure 32 NAT Traversal Configuration	98
Figure 33 SIP Configuration	99
Figure 34 PHONE	101
Figure 35 System Settings	103
Figure 36 TOS/DIFFSERV	104
Figure 37 Load Factory Default Settings	107
Figure 38 Single-Computer per Router Hardware Configuration	120

Figure 39 Prestige as a PPPoE Client	120
Figure 40 Peer-to-Peer Communication in an Ad-hoc Network	121
Figure 41 Basic Service Set	122
Figure 42 Infrastructure WLAN	123
Figure 43 Roaming Example	124

List of Tables

Table 1 Prestige Hardware Descriptions	26
Table 2 LCD Main Screen	29
Table 3 Web Configurator User Screens Summary	71
Table 4 Web Configurator Administrator Screens Summary	71
Table 5 Device Information	73
Table 6 Private IP Address Ranges	73
Table 7 STATIC	76
Table 8 DHCP	77
Table 9 PPPoE	78
Table 10 SIP Call Progression	80
Table 11 SIP	83
Table 12 NAT Types	85
Table 13 NAT Traversal Configuration	90
Table 14 Phonebook	92
Table 15 Wireless Setting	94
Table 16 System	95
Table 17 S/W Update	96
Table 18 NAT Traversal Configuration	98
Table 19 SIP Configuration	99
Table 20 PHONE	102
Table 21 System	103
Table 22 TOS/DIFFSERV	104
Table 23 Troubleshooting the Start-Up of Your Prestige	105
Table 24 Troubleshooting the Keypad	105
Table 25 Troubleshooting Accessing the Prestige	106
Table 26 Warning Message Troubleshooting	106
Table 27 Error Message Troubleshooting	107
Table 28 Hardware Specifications	109
Table 29 Firmware Features	110
Table 30 Classes of IP Addresses	111
Table 31 Allowed IP Address Range By Class	112
Table 32 "Natural" Masks	112
Table 33 Alternative Subnet Mask Notation	113
Table 34 Two Subnets Example	113
Table 35 Subnet 1	114
Table 36 Subnet 2	114
Table 37 Subnet 1	115
Table 38 Subnet 2	115

Table 39 Subnet 3	115
Table 40 Subnet 4	116
Table 41 Eight Subnets	116
Table 42 Class C Subnet Planning	116
Table 43 Class B Subnet Planning	117

Preface

About Your Prestige

Congratulations on your purchase of the Prestige 2000W_V2 VoIP Wi-Fi Phone.

About This User's Manual

This manual is designed to help you configure the Prestige and provide background information on its features.

Note: You may use the keypad and the LCD screen menus or the web configurator to configure your Prestige.

Related Documentation

- Supporting Disk
Refer to the included CD for support documents.
- Quick Start Guide
The Quick Start Guide is designed to help you get up and running right away. It contains connection information and instructions on getting started.
- ZyXEL Glossary and Web Site
Please refer to www.zyxel.com for an online glossary of networking terms and additional support documentation.









Syntax Conventions

- “Enter” means for you to type one or more characters and press the carriage return. “Select” or “Choose” means for you to use one of the predefined choices.
- The choices of a menu item are in **Bold Arial** font.
- A single keystroke is in **Arial** font and enclosed in square brackets, for instance, [ENTER] means the Enter, or carriage return, key; [ESC] means the escape key and [SPACE BAR] means the space bar. [UP] and [DOWN] are the up and down arrow keys.
- Mouse action sequences are denoted using a comma. For example, “click the Apple icon, **Control Panels** and then **Modem**” means first click the Apple icon, then point your mouse pointer to **Control Panels** and then click **Modem**.
- “e.g.,” is a shorthand for “for instance”, and “i.e.,” means “that is” or “in other words”.

User Guide Feedback

Help us help you. E-mail all User Guide-related comments, questions or suggestions for improvement to techwriters@zyxel.com.tw or send regular mail to The Technical Writing Team, ZyXEL Communications Corp., 6 Innovation Road II, Science-Based Industrial Park, Hsinchu, 300, Taiwan. Thank you.

Graphics Icons Key

<p>Prestige</p> 	<p>Computer</p> 	<p>Notebook Computer</p> 
<p>Server</p> 	<p>Switch</p> 	<p>Router</p> 
<p>Telephone</p> 	<p>Trunking Gateway</p> 	<p>Wireless Signal</p> 

CHAPTER 1

Getting To Know Your Prestige

This chapter describes the key features and applications of your Prestige.

The Prestige 2000W_V2 is a wireless telephone that operates over the Internet. It gives you the benefits of Internet telephony, for example cheaper calls, without the physical restrictions of a fixed Internet connection (it provides mobility).

Sending compressed voice signals over the Internet is called Voice over IP or VoIP. The Prestige is a Session Initiated Protocol (SIP) - based wireless VoIP telephone. SIP is an internationally recognized standard for implementing VoIP.

The Prestige allows you to make and receive VoIP calls as long you are within range of an IEEE 802.11b enabled wireless network.

The Prestige is easy to use and configure via the LCD display and keypad. You can even manage your settings over the Internet using the Prestige's web configurator.

1.1 Features

Dynamic Jitter Buffer

The Prestige has a built-in adaptive, buffer that helps to smooth out the variations in delay (jitter) for voice traffic. This helps ensure good voice quality for your conversations.

QoS (Quality of Service)

Quality of Service (QoS) mechanisms help to provide better service on a per-flow basis. The Prestige supports Type of Service (ToS) and Differentiated Services (DiffServ). This allows the Prestige to tag voice frames so they can be prioritized over the network.

Auto-provisioning

Auto-provisioning automatically updates your Prestige's configurable settings via a server hosted by your VoIP service provider.

STUN

Simple Traversal of User Datagram Protocol (UDP) through Network Address Translators (STUN) allows SIP to pass through NAT routers.

Outbound Proxy

Some VoIP service providers use a SIP outbound server to handle voice calls. This allows the Prestige to work from behind any type of NAT router and eliminates the need for STUN or a SIP ALG (Application Layer Gateway).

Voice Coding

The Prestige can use the following voice codecs (coder/decoders).

- G.711
- G.729

Voice Activity Detection/Silence Suppression

Voice Activity Detection (VAD) reduces the bandwidth that a call uses by not transmitting when you are not speaking. This also helps increase the battery lifetime.

Comfort Noise Generation

The Prestige generates background noise to fill moments of silence when the other device in a call stops transmitting because the other party is not speaking (as total silence could easily be mistaken for a lost connection).

PPPoE

PPPoE (Point-to-Point Protocol over Ethernet) facilitates the interaction of a host with an Internet modem to achieve access to high-speed data networks via a familiar "dial-up networking" user interface.

Firmware Upgrades

Use the web configurator to upload updated firmware to your Prestige.

1.2 Applications

Here are some examples of how you can use your Prestige.

1.2.1 Place a Call via “SIP Proxy Server” (SIP Call Server)

When you have a (IEEE 802.11b) wireless connection to the Internet, you can use the Prestige to make and receive VoIP telephone calls through an Internet Telephony Service Provider's (ITSP) call server.

You don't need to know if the recipient's connection type is an IP, cellular or landline based service. Your Prestige can call any landline or mobile telephone that a traditional PSTN telephone can connect to as well the IP telephone network. Calls received from IP telephones works exactly as you would expect from the traditional telephone service.

Figure 1 SIP Proxy Server Application

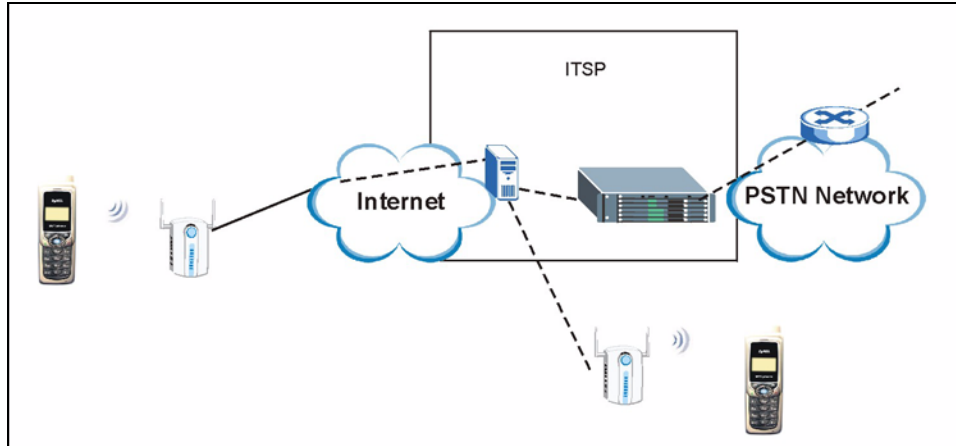

The Prestige registers with a SIP proxy server in the following circumstances:

- Your connection uses an IP Telephony Service.
- Your connection is based in a corporate VoIP environment.

1.2.2 Direct IP to IP Calling

Use the Prestige to make a call to the recipient's IP address without using a SIP proxy server.

Figure 2 IP to IP Calling

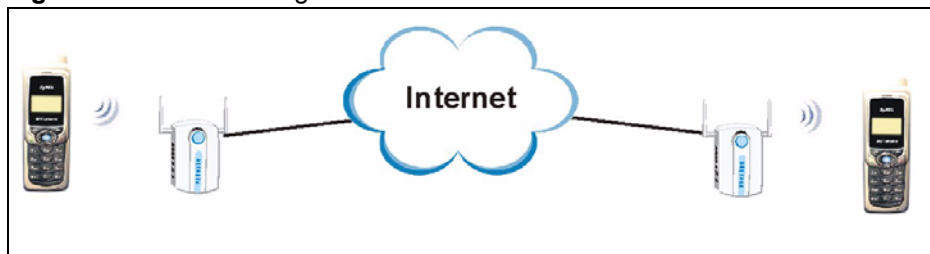

1.2.3 Ad-Hoc (Wireless Intercom)

Ad-hoc mode does not require an AP or a wired network. Two or more wireless clients communicate directly with each other.

- There is no intermediate SIP proxy server
- Use the phone book to directly call to the recipient's IP address.
- The wireless mode is set to "Ad-hoc", with the same SSID and channel

Figure 3 Ad-Hoc Mode

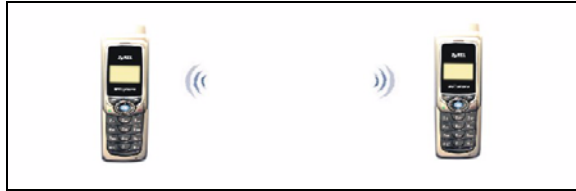

1.3 Getting to Know the Prestige Hardware

Figure 4 Prestige Hardware



Table 1 Prestige Hardware Descriptions

NAME	DESCRIPTION
1 LCD Screen	Use this screen to display information and navigate the phone's menus.
2 Left Key	Use the Left key to open the on-screen menus and select options.
3 Right Key	Use the Right key to return to the previous menu. It is also a shortcut to the phone book.
4 Arrow Keys	Use the arrow keys to navigate between menus and move the cursor. Use the left arrow key to clear text in an editable field.
5 OK Key	Use this key to select menu options from the LCD screen.
6 Call Key	Use the Call key to make and receive calls.
7 Power/End	Use the Power/End key to reject or cancel calls. Press and hold it for approximately 2 seconds to turn the Prestige on or off.
8 Alphanumeric Keypad	Use these keys to enter numbers, letters and symbols.
9 Headset Jack	Use this jack (located underneath rubber cover) to connect an optional headset.

Table 1 Prestige Hardware Descriptions (continued)

NAME	DESCRIPTION
10 Volume Keys	Use these keys to increase or decrease the ear piece volume.
11 Power Jack	Connect the phone's power adapter here to charge the battery.

CHAPTER 2

Using the LCD Screen Menus

This section introduces the Prestige's LCD screen menu system.

Note: See the web configurator section of this guide for background information on the Prestige's features.

2.1 LCD Main Screen

Press the **Power/End** key for two seconds to turn on the Prestige. The Prestige searches for the available wireless network with the best signal. It then restarts and attempts to connect to the wireless network.

This is the main screen.

Figure 5 LCD Main Screen

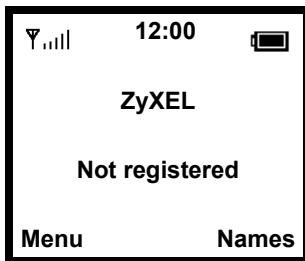

Table 2 LCD Main Screen

LABEL	DESCRIPTION
📶	This icon shows the strength of the wireless LAN signal.
12:00	The time displays in the top center.
🔋	This icon shows the battery's current charge.
ZyXEL	This field is a banner that you can configure.
Not Registered	This the Prestige's current connection status. Not registered displays when the Prestige can access the wireless network and the Internet but has not registered with the SIP proxy server. Registered displays after the menu settings are properly configured and the Prestige connects to the SIP proxy server (the settings may have already been configured for you). If any other message displays the Prestige may not be able to access the wireless network or the Internet.

Table 2 LCD Main Screen

LABEL	DESCRIPTION
Menu	This is the function of the Left key. Press the Left key from the main screen to open the menus.
Names	This is the function of the Right key. Press the Right key from the main screen to open the phonebook.

2.2 Navigating the LCD Screen Menus

Press the **Left** button to enter the menus.

After you enter the menus, use the **Up** or **Down** arrow keys to scroll through the menu items.

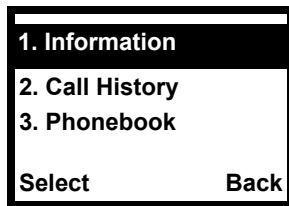
Figure 6 LCD Screen Menu Navigation

- Press the **Left** key to access the selected menu item.
- Press the **Right** key to return to the previous screen.

Note: The Prestige restarts when you return to the main screen after configuring the wireless LAN, network or SIP settings.

2.2.1 Text Input

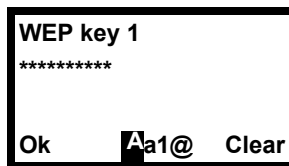
Figure 7 Text Input

- When you need to enter text or numbers in a screen, use the **Off** key or the left arrow to clear the default text or backspace.
- The bottom center of the screen shows the keypad mode **Aa1@**, with the **A** mode highlighted. Use the up and down arrows to select capital letters (**A**), lowercase letters (**a**), numbers (**1**), or symbols (**@**).

- Use the keypad to enter the text. You may need multiple keypad presses to enter letters. For example, to enter a lowercase “**b**”, press the down arrow key to select lowercase mode (**a**), then press the “**2**” key twice. Use the left arrow key to remove typos.
- Press the **OK** key when you are done.

CHAPTER 3

Wireless LAN Setup Menus

First you need to associate your Prestige with a Wireless LAN Access Point (AP). This provides your Prestige with the basic services for communication.

When you turn the Prestige on, it searches for available wireless LAN Access Points (APs). It selects the AP with the best signal and restarts and attempts to connect to it.

Use the following sections if you want to enter a WEP key or manually specify other wireless settings. The Prestige restarts when you return to the main screen after changing the wireless settings.

3.1 Site Survey

Do the following to browse the APs available in your area and select one.

- 1** Select **Wireless** in the first menu screen (use the up or down arrow to highlight it and then press the **Left** key).
- 2** Select **Site Survey**.
- 3** The Prestige checks for and displays a list of available APs.
- 4** An AP's SSID (name) is followed by a number describing its relative signal strength. The higher the number, the better the signal. A "W" next to an AP's name means that the AP uses WEP encryption. Select an AP to use.

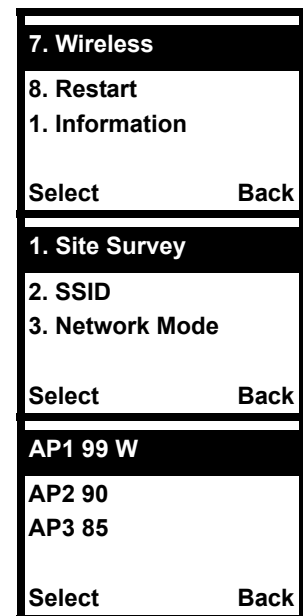

3.2 SSID

(Service Set ID) The SSID identifies the Service Set with which a wireless station is associated. Wireless stations associating to the access point (AP) must have the same SSID. You can think of the SSID as being similar to a workgroup name in a Microsoft network. Do the following to set the SSID that the Prestige is to use.

- 1 Select **Wireless** in the first menu screen (use the up or down arrow to highlight it and then press the **Left** key).

- 2 Select **SSID**.

- 3 The Prestige displays the SSID that it is currently using. You can clear the SSID and enter a different one if you need to.

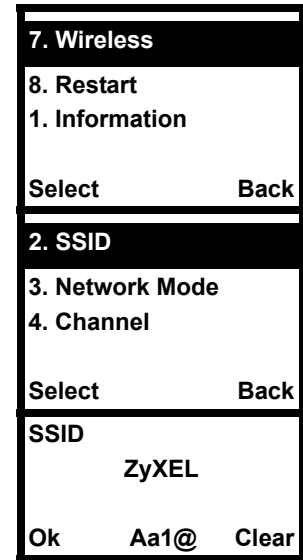

3.3 Network Mode

The **Ad Hoc** network is the simplest WLAN configuration, consisting of two or more wireless devices within range of each other that form an independent network without the need of an access point (AP).

An **Infra.** (infrastructure) network has an AP that allows wireless clients to connect to the wired network.

Do the following to select the network mode that the Prestige is to use.

- 1 Select **Wireless** in the first menu screen (use the up or down arrow to highlight it and then press the **Left** key).

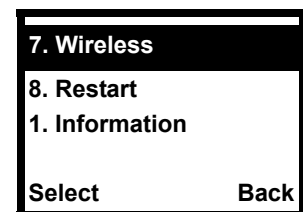

2 Select Network Mode.

- 3 Select **Infra.** to access an AP.**
 Select **Ad Hoc** to form an independent network with another wireless client (like another Prestige for example) without the need of an AP.

3. Network Mode	
4. Channel	
5. Rate	
Select	Back
[2] Infra.	
[1] Ad Hoc	
OK	Back

3.4 Channel

A radio frequency used by a wireless device is called a channel. The Prestige determines which channel to use when you do the site survey and select the AP. Do the following to display the channel that the Prestige is using.

- 1 Select **Wireless** in the first menu screen (use the up or down arrow to highlight it and then press the **Left** key).**

2 Select Channel.

- 3 The Prestige displays the channel that it is currently using.**

7. Wireless	
8. Restart	
1. Information	
Select	Back
4. Channel	
5. Rate	
6. WEP Select	
Select	Back
Channel	
6	
OK	Back

3.5 Rate

Do the following to set the transfer rate of the Prestige's wireless connection to the AP.

- 1 Select **Wireless** in the first menu screen (use the up or down arrow to highlight it and then press the **Left** key).
- 2 Select **Rate**.
- 3 Select **Auto** to have the Prestige automatically use the highest rate that the wireless connection to the AP will support. Select another rate to have the Prestige connect to the AP at only that rate.

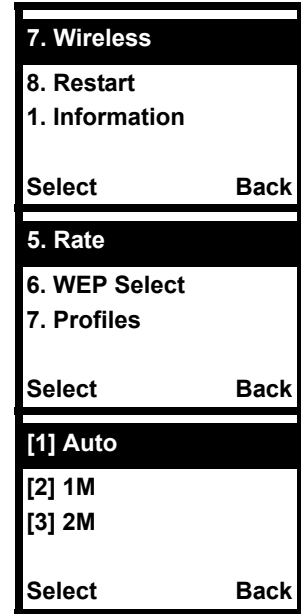

3.6 WEP Encryption

WEP (Wired Equivalent Privacy) encryption scrambles all communications transmitted between the Prestige and the AP to keep them private.

- 1 Select **Wireless** in the first menu screen (use the up or down arrow to highlight it and then press the **Left** key).
- 2 Use the up or down arrow and the **Left** key to select **WEP Select**.
- 3 Select the same length of WEP keys as the AP (64-bit or 128-bit).

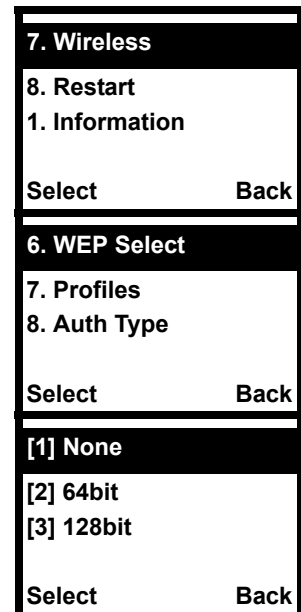

- 4 Select a WEP key to configure.
- 5 Select a keypad mode and use the keypad to enter the WEP key that the AP is using. Use the **Power/End** key to clear the default text and remove typos.
Press the **OK** key when you are done.
- 6 You can configure up to four WEP keys (in the same manner as the first) but only one key can be selected (enabled) at any one time.
- 7 Select **Key Select**.
- 8 Select the key that the AP is using.

7. WEP key 1	
8. WEP key 2 9. WEP key 3	
Select	Back
WEP key 1 *****	
Ok	Aa1@ Clear
8. WEP key 2	
9. WEP key 3 10. WEP key 4	
Select	Back
11. Key Select	
12. Profiles 13. Auth Type	
Select	Back
Key 1	
Key 2 Key 3	
Select	Back

3.7 Authentication Type

Some APs require the wireless clients to send the WEP key to the AP for authentication.

Note: Only set the authentication type to shared key if the wireless clients are required to send the WEP key to the AP for authentication (not just for encryption). Many networks use an open system where you would only use WEP for encryption, not for authentication.

1 Select **Wireless** in the first menu screen (use the up or down arrow to highlight it and then press the **Left** key).

2 Use the up or down arrow and the **Left** key to select **Auth Type**.

3 Select **Shared Key** if the wireless clients need to send the WEP key to the AP for authentication.
 Select **Open System** if the wireless clients do not need to send the WEP key to the AP for authentication.

4 The Prestige restarts when you return to the main screen.

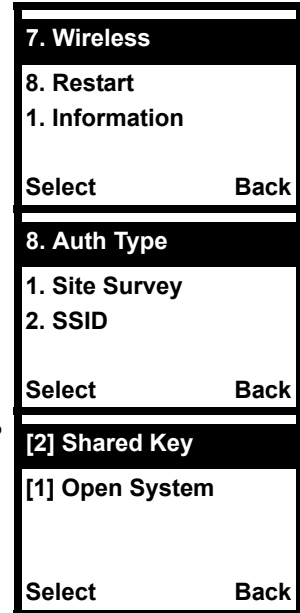

3.8 Profiles

Use a profile to save your wireless settings for future use.

1 Select **Wireless** in the first menu screen (use the up or down arrow to highlight it and then press the **Left** key).

2 Use the up or down arrow and the **Left** key to select **Profiles**.

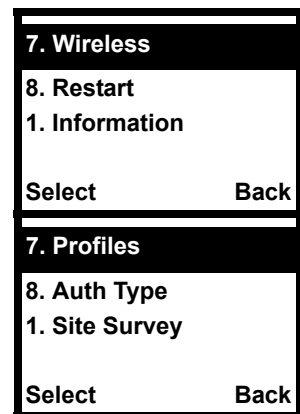

- 3** Select **Create** to make a new profile.
Select **Activate** to use an existing profile.
Select **Remove** to delete a profile.

- 4** When creating a profile, select a number for the profile and press the **Left** key. The profile uses the name of the AP that you are using.
When activating or removing a profile, select the profile.

- 5** The Prestige restarts when you return to the main screen.

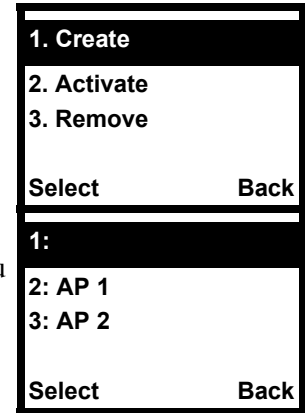

CHAPTER 4

Network Settings

Use this chapter to configure your Prestige to access the Internet. The Prestige restarts when you return to the main screen after changing the network settings.

If you were given a user name and password for Internet access, go to [Section 4.3 on page 43](#).

If you were given an IP address and subnet mask, go to [Section 4.1 on page 41](#).

If you were not given an IP address and subnet mask, go to [Section 4.2 on page 42](#).

4.1 Fixed IP

With this option you have to manually enter an IP address, subnet mask and gateway IP address. These are given to you by the network administrator.

- 1 Select **Net Settings** in the first menu screen (use the up or down arrow to highlight it and then press the **Left** key).
- 2 Select **Network Mode**.
- 3 Select **Fixed IP**.
- 4 Select **IP Address**.

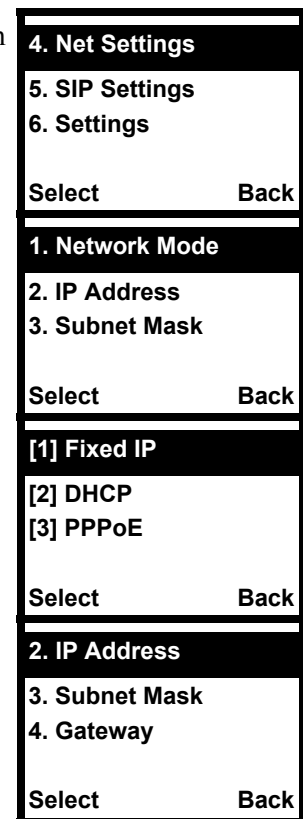

- 5 Use the left arrow button to clear the IP address. Use the up and down arrows to select the type of characters. Enter your IP address. Use the **Left** key to select **Ok** when you are done.
- 6 Select **Subnet Mask**.
- 7 Clear the subnet mask and enter your's. The subnet mask specifies the network number portion of an IP address. Type the subnet mask given to you by your network administrator. See the appendix for information on subnetting.
- 8 Select **Gateway**.
- 9 Clear the gateway IP address and enter your's.

IP Address		
192.168.1.3		
Ok	Aa1@	Clear
3. Subnet Mask		
4. Gateway		
1. Network Mode		
Select	Back	
Subnet Mask		
255.255.255.0		
Ok	Aa1@	Clear
4. Gateway		
1. Network Mode		
2. IP Address		
Select	Back	
Gateway		
192.168.1.1		
Ok	Aa1@	Clear

4.2 DHCP

If you were not assigned a specific IP address for your Prestige, use the following directions to set your Prestige to get it automatically via DHCP (Dynamic Host Control Protocol).

- 1 Select **Net Settings** in the first menu screen (use the up or down arrow to highlight it and then press the **Left** key).

4. Net Settings	
5. SIP Settings	
6. Settings	
Select	Back

2 Select Network Mode.

3 Select DHCP.

1. Network Mode	
2. IP Address	
3. Subnet Mask	
Select	Back
[2] DHCP	
[3] PPPoE	
[1] Fixed IP	
Select	Back

4.3 PPPoE

Point-to-Point Protocol over Ethernet (**PPPoE**) functions like a dial-up connection. You need a user name (PPPoE name) and password from your ISP.

1 Select Net Settings in the first menu screen (use the up or down arrow to highlight it and then press the **Left** key).

2 Select Network Mode.

3 Select PPPoE.

4 Select PPPoE Name.

5 Use the left arrow button to clear the PPPoE name. Use the up and down arrows to select the type of characters. Enter your PPPoE name. Use the **Left key to select **Ok** when you are done.**

4. Net Settings	
5. SIP Settings	
6. Settings	
Select	Back
1. Network Mode	
2. IP Address	
3. Subnet Mask	
Select	Back
[3] PPPoE	
[1] Fixed IP	
[2] DHCP	
Select	Back
2. PPPoE Name	
3. PPPoE Pwd	
1. Network Mode	
Select	Back
PPPoE Name	
pppoe_username	
Ok	Aa1@ Clear

6 Select **PPPoE Pwd**.

7 Clear the PPPoE password and enter your's.

The screenshot shows a terminal-style menu with a black background and white text. At the top, it says '3. PPPoE Pwd'. Below that are two numbered options: '1. Network Mode' and '2. PPPoE Name'. There are two buttons, 'Select' and 'Back', positioned below the options. A horizontal line separates this from the next section, which is titled 'PPPoE Pwd'. Below the title is a line of asterisks representing a password input field. At the bottom, there are three buttons: 'Ok', 'Aa1@', and 'Clear'.

CHAPTER 5

SIP Settings

The Prestige uses Session Initiated Protocol (SIP), an internationally recognized standard for implementing VoIP.

You must register your Prestige with your VoIP service provider's SIP server.

Note: You should have a voice account already set up.

5.1 Registrar Server

Configure the **Registrar** settings to have the Prestige register with your provider's SIP registrar server.

Note: If you have no registrar server information, use the SIP server IP address and port number.

1 Select **SIP Settings** in the first menu screen.

2 Select **Registrar**.

3 Select **Registrar IP**.

4 Use the left arrow button to clear the default text. Use the up and down arrows to select the type of characters. Enter the registrar server's IP address or domain name. Use the **Left** key to select **Ok** when you are done.

5. SIP Settings		
6. Settings		
7. Wireless		
Select		Back
1. Registrar		
2. OutboundProxy		
3. Proxy Server		
Select		Back
1. Registrar IP		
2. Port		
3. Expiry Time		
Select		Back
Registrar IP		
sip.proxy.net		
Ok	Aa1@	Clear

5 Select Port.

6 Clear the port and enter the registrar server's listening port number. Leave the default port number if you were not given one to use.

7 Select **Expiry Time** if you were given a specific expiration time period to use. Otherwise leave it set to the default.

8 Clear the expiration time and enter the expiration time you were given.

9 The Prestige restarts when you return to the main screen.

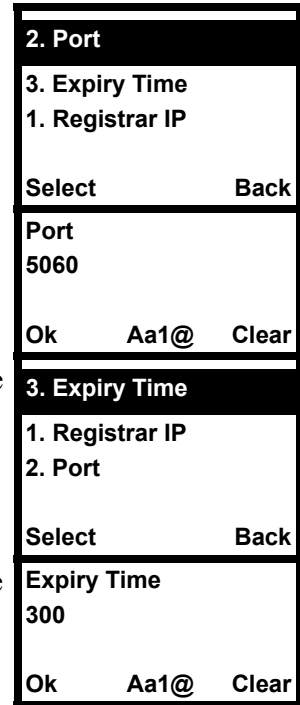

5.2 Outbound Proxy Server

You may need to configure the Prestige to use an **Outbound Proxy** server if your LAN is behind a NAT router that does not support SIP. If your VoIP service provider gave you an outbound proxy server address and port, then enter them here.

1 Select **SIP Settings** in the first menu screen.

2 Select **Outbound Proxy**.

3 Select **Proxy IP**.

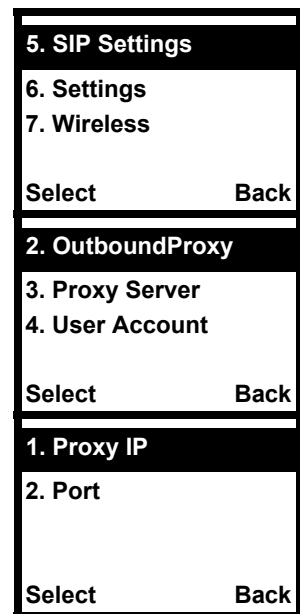

- 4** Use the left arrow button to clear the default text. Use the up and down arrows to select the type of characters. Enter the outbound proxy server's IP address or domain name. Use the **Left** key to select **Ok** when you are done.

- 5** Select **Port**.

- 6** Clear the port and enter the SIP outbound proxy server's listening port number. Leave the default port number if you were not given one to use.

Proxy IP		
sip.proxy.net		
Ok	Aa1@	Clear
2. Port		
1. Proxy IP		
Select	Back	
Port		
5060		
Ok	Aa1@	Clear

5.3 Proxy Server

Configure **Proxy Server** settings to have the Prestige use your VoIP service provider's SIP-server.

- 1** Select **SIP Settings** in the first menu screen.

- 2** Select **Proxy Server**.

- 3** Select **Proxy IP**.

- 4** Use the left arrow button to clear the default text. Use the up and down arrows to select the type of characters. Enter the SIP server's IP address or domain name. Use the **Left** key to select **Ok** when you are done.

5. SIP Settings	
6. Settings	
7. Wireless	
Select	Back
3. Proxy Server	
4. User Account	
1. Registrar	
Select	Back
1. Proxy IP	
2. Port	
Select	Back
Proxy IP	
sip.proxy.net	
Ok	Aa1@ Clear

5 Select Port.

6 Clear the port and enter the SIP server's listening port number. Leave the default port number if you were not given one to use.

2. Port		
1. Proxy IP		
Select	Back	
Port		
5060		
Ok	Aa1@	Clear

5.4 User Account

Configure the Prestige to use your **User Account** for registering with the SIP server.

When you registered for your voice account, you should have been given a telephone number, user name and password for connecting to the SIP proxy server. Do the following to set up your Prestige to use your telephone number, user name and password when connecting to the SIP server.

1 Select **SIP Settings** in the first menu screen.

2 Select **User Account**.

3 Select **Phone Number**.

4 Use the left arrow button to clear the default text. Use the up and down arrows to select the type of characters. Enter your SIP number. For a SIP account like 1234@VoIP-provider.com, "1234" would be the SIP number. Use the **Left** key to select **Ok** when you are done.

5. SIP Settings		
6. Settings		
7. Wireless		
Select	Back	
4. User Account		
1. Registrar		
2. OutboundProxy		
Select	Back	
1. Phone Number		
2. Username		
3. User Pwd		
Select	Back	
Phone Number		
100		
Ok	Aa1@	Clear

5 Select Username.

6 Clear the user name and enter yours exactly as it was given to you.

7 Select User Pwd.

8 Clear the password and enter yours exactly as it was given to you.

9 The Prestige restarts when you return to the main screen.

2. Username		
3. User Pwd		
1. Phone Number		
Select		Back
Username		
username		
Ok	Aa1@	Clear
3. User Pwd		
1. Phone Number		
2. Username		
Select		Back
User Pwd		

Ok	Aa1@	Clear

CHAPTER 6

Phonebook

Use the phonebook feature to store and later retrieve names and corresponding telephone numbers.

The following sections describe how to create and erase phonebook entries.

6.1 Calling Methods

There are two ways the Prestige can dial a telephone number; either by using the SIP proxy server or an IP address.

- Select **Proxy** to have the SIP server make the connection.
- Select **P2P** to an IP address to place a call without first going through the SIP proxy server. This is called an IP to IP (or peer to peer) call. You need to enter the IP address of the callee or another SIP proxy server.

6.2 Adding a Phonebook Entry

Use the following instructions to add an entry to your phonebook.

Note: Only enter the IP address when there is no SIP proxy server or you want to place a direct IP to IP call. Otherwise the name and telephone number are sufficient to make your call.

You must use a phonebook entry to make an IP to IP call.

1 Select **Phonebook** in the first menu.

2 Select **Add Entry**.

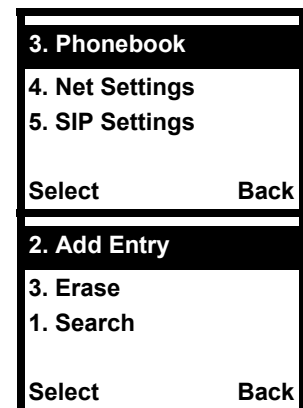

- 3 Enter the callee's name. Use the up and down arrows to select the type of characters. Use the **Left** key to select **Ok** when you are done.
- 4 Enter the telephone number.
- 5 Enter the SIP server's or the callee's IP address or domain name. Leave this blank if you will use the SIP proxy server to call this number.
- 6 Enter the callee's listening port number. Leave this blank if you were not given one.
- 7 Select **P2P** if calls to this party use a different SIP server or go directly to the callee's VoIP phone (peer-to-peer). Select **Proxy** if calls to this party use your SIP account.

Display Name:		
Ok	Aa1@	Clear
User Info:		
Ok	Aa1@	Clear
Host IP:		
Ok	Aa1@	Clear
Port:		
Ok	Aa1@	Clear
P2P		
Proxy		
Select		Back

6.3 Editing Phonebook Entries

Use the following instructions to locate and edit an existing entry in your phonebook.

- 1 Select **Phonebook** in the first menu.
- 2 Select **Search**.

3. Phonebook	
4. Net Settings	
5. SIP Settings	
Select	Back
1. Search	
2. Add Entry	
3. Erase	
Select	Back

- 3 Select an entry.

Note: An empty mailbox icon displays if there are no entries in the phonebook.

- 4 Select **Edit**. Then edit the entry in the same manner that you add one (see [Section 6.2 on page 51](#)).

Alan
Amy
Ann
Select Back
1. Edit
2. Erase
3. Speed Dial
Select Back

6.4 Erasing Phonebook Entries

Use the following instructions to remove an existing entry from your phonebook.

- 1 Select **Phonebook** in the first menu.

- 2 Select **Erase**.

- 3 Select **One by One** to delete individual phonebook entries.

Select **Erase All** to delete every phonebook entry. “Are you sure?” displays. Press the **Left** key to delete all entries or press the **Right** key to keep the entries.

- 4 If you chose **One by One**, select an entry.

Note: An empty mailbox icon displays if there are no entries in the phonebook.

- 5 Press the **Left** key to confirm that you want to delete the entry or press the **Right** key to keep the entry.

3. Phonebook
4. Net Settings
5. SIP Settings
Select Back
3. Erase
1. Search
2. Add Entry
Select Back
1. One by One
2. Erase All
Select Back
Alan
Amy
Ann
Select Back
Are you sure?
Select Back

6.5 Speed Dial Phonebook Entries

Use the following instructions to make an existing phonebook entry into a speed dial entry.

1 Select **Phonebook** in the first menu.

2 Select **Search**.

3 Select an entry.

Note: An empty mailbox icon displays if there are no entries in the phonebook.

4 Select **Speed Dial**.

5 Select a key to use for the speed dial entry.

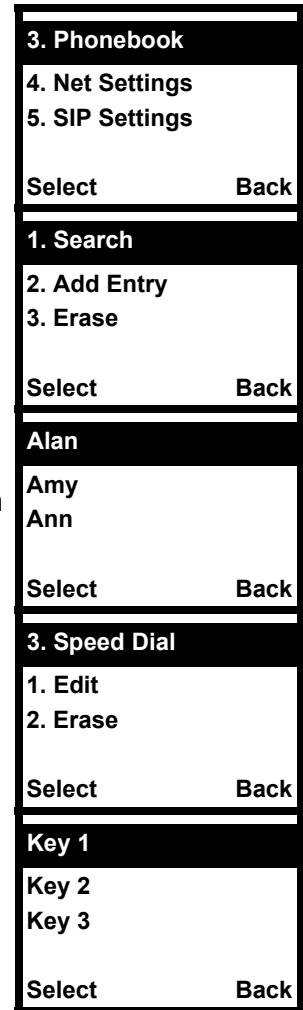

Press a configured speed dial entry's key for about two seconds to dial the entry.

CHAPTER 7

Call History

The call history feature is useful for checking missed, received, and dialed calls.

7.1 Missed Calls

Follow these directions to use the missed calls list to check for missed calls and then edit and save (or erase) the telephone numbers.

1 Select **Call History** in the first menu.

2 Select **Missed**.

3 Select an entry.

Note: An empty mailbox icon displays if there are no entries in the phonebook.

4 Select **Edit Missed** to save the number.
Select **Erase Missed** to delete the number. “Are you sure?” displays. Press the **Left** key to delete the entry or press the **Right** key to keep the entry.

5 If you selected **Edit Missed**, edit the number or just press the **Left** key if the number does not need editing.

6 Enter the caller's name.

2. Call History		
3. Phonebook		
4. Net Settings		
Select	Back	
1. Missed		
2. Received		
3. Dialed		
Select	Back	
1234		
5678		
2222		
Select	Back	
1. Edit Missed		
2. Erase Missed		
Select	Back	
Number:		
1234		
Ok	Aa1@	Clear
Name:		
Ok	Aa1@	Clear

7.2 Received Calls

Follow these directions to use the received calls list to check for received calls and then edit or erase the telephone numbers.

1 Select **Call History** in the first menu.

2 Select **Missed**.

3 Select an entry.

Note: An empty mailbox icon displays if there are no entries in the phonebook.

4 Select **Edit Received** to save the number.
 Select **Erase Received** to delete the number. "Are you sure?" displays. Press the **Left** key to delete the entry or press the **Right** key to keep the entry.

5 If you selected **Edit Received**, edit the number or just press the **Left** key if the number does not need editing.

6 Enter the caller's name.

2. Call History		
3. Phonebook		
4. Net Settings		
Select		Back
2. Received		
3. Dialed		
1. Missed		
Select		Back
1234		
5678		
2222		
Select		Back
1. Edit Received		
2. Erase Received		
Select		Back
Number:		
1234		
Ok	Aa1@	Clear
Name:		
Ok	Aa1@	Clear

7.3 Dialed Calls

Follow these directions to use the list of telephone numbers the Prestige has been used to call to check the list of telephone numbers that have been called and then edit or erase the telephone numbers.

1 Select **Call History** in the first menu.

2 Select **Dialed**.

3 Select an entry.

Note: An empty mailbox icon displays if there are no entries in the phonebook.

4 Select **Edit Dialed** to save the number.
Select **Erase Dialed** to delete the number. "Are you sure?" displays. Press the **Left** key to delete the entry or press the **Right** key to keep the entry.

5 If you selected **Edit Dialed**, edit the number or just press the **Left** key if the number does not need editing.

6 Enter the callee's name.

2. Call History		
3. Phonebook		
4. Net Settings		
Select	Back	
3. Dialed		
4. Erase Calls		
1. Missed		
Select	Back	
1234		
5678		
2222		
Select	Back	
1. Edit Dialed		
2. Erase Dialed		
Select	Back	
Number:		
1234		
Ok	Aa1@	Clear
Name:		
Ok	Aa1@	Clear

7.4 Erasing Calls

Follow these directions to erase entries from the call history list. You can choose to erase all call records, the missed calls, the received calls, or the dialed calls.

1 Select **Call History** in the first menu.

2 Select **Erase Calls**.

3 Select **Erase All** to remove all entries from the call history.
Select **Missed** to remove the missed call entries.
Select **Received** to remove the received call entries.
Select **Dialed** to remove the dialed call entries.

4 Press the **Left** key to confirm that you want to delete the entry or press the **Right** key to keep the entries.

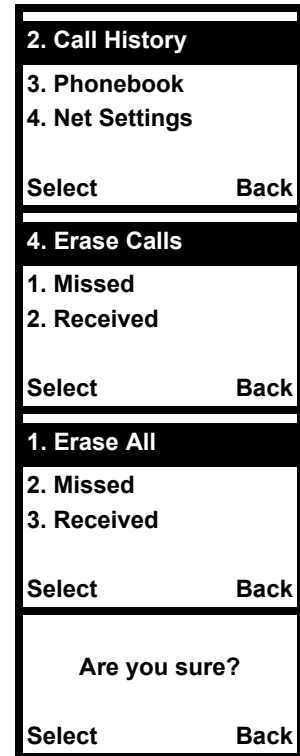

CHAPTER 8

Miscellaneous Settings

These sections detail how to change the Prestige's other settings.

8.1 Setting the Ring Melody

Follow these directions to change the Prestige's ring melody.

1 Select **Settings** in the first menu screen.

2 Select **Melody**.

3 Select a melody.

4 Press the **Left** key to save your setting.

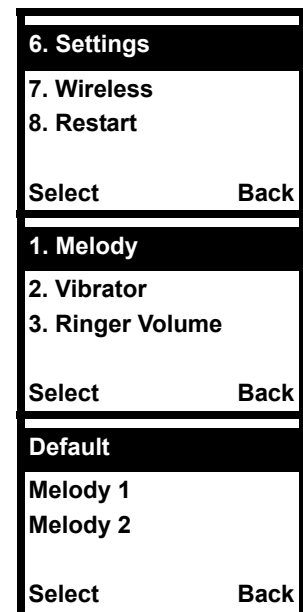

8.2 Setting the Vibration Mode

You can have the Prestige vibrate to alert you to incoming calls. Follow these directions to turn the Prestige's vibration mode on or off.

1 Select **Settings** in the first menu screen.

2 Select **Vibrator**.

3 Select **Ring Only** to have the Prestige not vibrate for incoming calls.

Select **Vibrate Only** to have the Prestige only vibrate and not ring for incoming calls.

Select **Vibrate -> Ring** to have the Prestige vibrate first and then ring for incoming calls.

Select **Vibrate & Ring** to have the Prestige vibrate and ring for incoming calls.

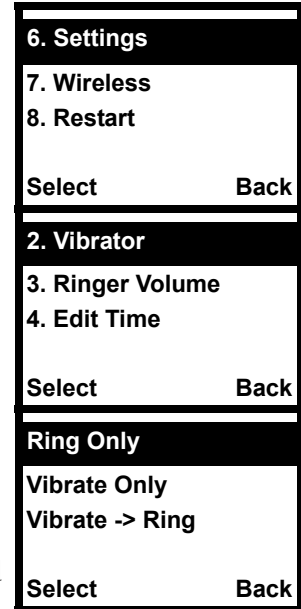

8.3 Adjusting the Ring Volume

Follow these directions to adjust the Prestige's ring volume.

1 Select **Settings** in the first menu screen.

2 Select **Ringer Volume**.

3 Use the arrow keys to set the volume level.

4 Press the **Left** key to save your setting.

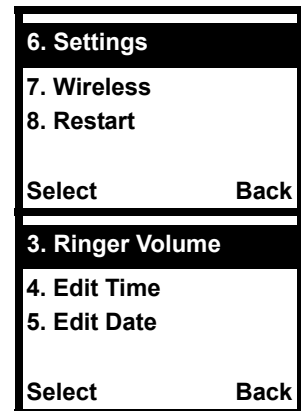

8.4 Setting the Time

Follow these directions to change the Prestige's time settings.

1 Select **Settings** in the first menu screen.

2 Select **Edit Time**.

3 Use the left arrow to move the cursor in front of the number you want to edit and use the keypad to change the number.

4 Press the **Left** key to save your setting.

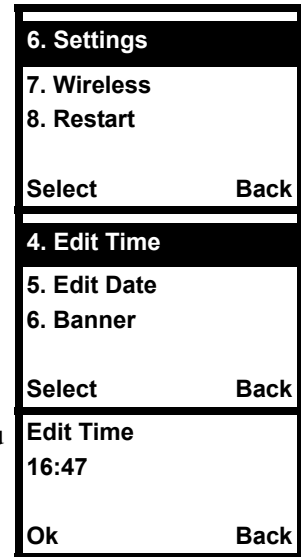

8.5 Setting the Date

Follow these directions to change the Prestige's time settings.

1 Select **Settings** in the first menu screen.

2 Select **Edit Date**.

3 Use the left arrow to move the cursor in front of the number you want to edit and use the keypad to change the number.

4 Press the **Left** key to save your setting.

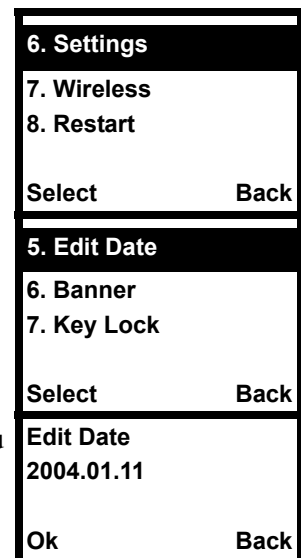

8.6 Setting the Banner

Follow these directions to change the text that displays in the Prestige's main screen.

- 1 Select **Settings** in the first menu screen.

- 2 Select **Banner**.

- 3 Enter the text that you want to display in the main screen.
- 4 Press the **Left** key to save your setting.

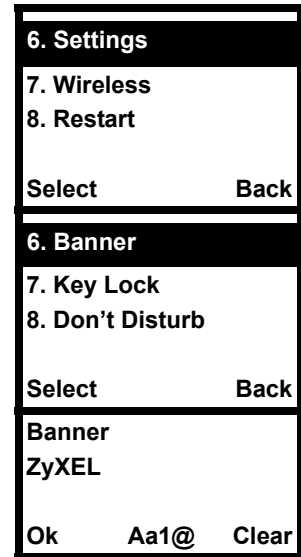

8.7 Setting the Key Lock

The Prestige's key lock function automatically locks the keypad if the Prestige is in standby mode for more than one minute (press and hold the # key for approximately 2 seconds to lock or unlock the keypad). Follow these directions to enable or disable the key lock function.

- 1 Select **Settings** in the first menu screen.

- 2 Select **Key Lock**.

- 3 Select **Off** to disable the key lock function or **On** to enable it.
- 4 Press the **Left** key to save your setting.

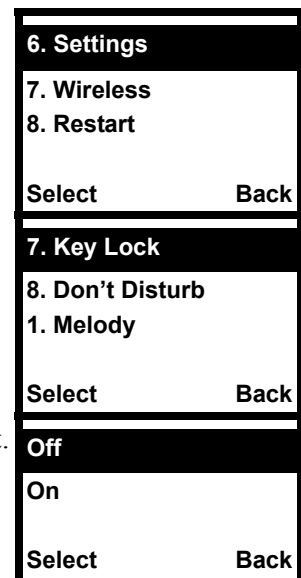

8.8 Setting the Don't Disturb

Enable the Prestige's don't disturb function, to not receive any incoming calls. Anyone calling the Prestige gets a busy signal when you enable the don't disturb function. Follow these directions to enable or disable the don't disturb function.

1 Select **Settings** in the first menu screen.

2 Select **Don't Disturb**.

3 Select **Off** to disable the don't disturb function or **On** to enable it.

4 Press the **Left** key to save your setting.

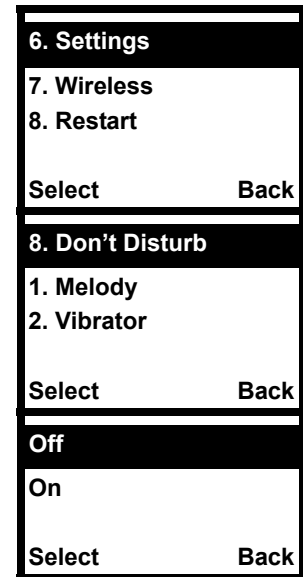

CHAPTER 9

Information Menus

These sections detail how to use the information menus.

9.1 Displaying Information

Follow these directions to display important Prestige information.

1 Select **Information** in the first menu screen.

2 Select **Phone Number**.

3 The screen displays the Prestige's current SIP phone number.

4 Press the **Right** key to return to the main information menu.

5 Select **IP Address**.

6 The screen displays the Prestige's current IP address.

7 Press the **Right** key to return to the main information menu.

8 Select **MAC Address**.

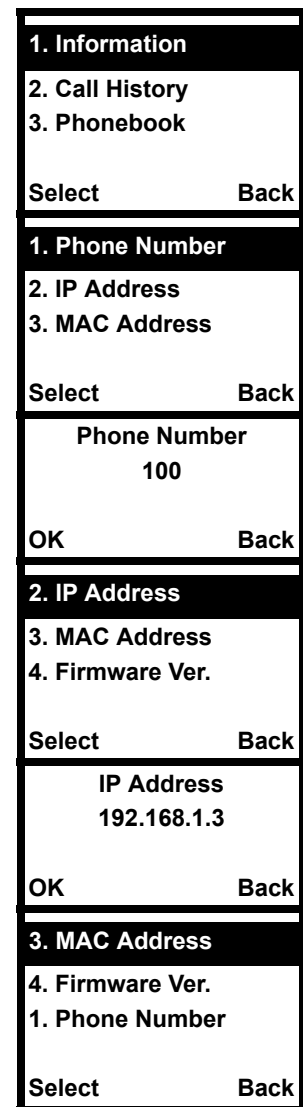

- 9** The screen displays the Prestige's MAC address.
- 10** Press the **Right** key to return to the main information menu.

- 11** Select **Firmware Ver.**

- 12** The screen displays the Prestige's current firmware version.

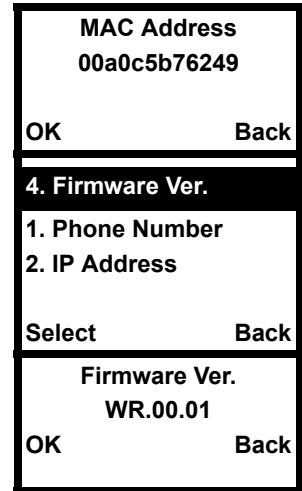

CHAPTER 10

Prestige Usage

This chapter describes how to use your Prestige for basic tasks.

10.1 Dialing a Telephone Number

Use the following instructions to call a number that is not already in your Prestige's phonebook.

- 1 When the Prestige is in standby mode, use the numerical keys to enter the telephone number.
- 2 If you enter an incorrect number, press the **Right** key to backspace.
- 3 Press the **Call** key to make your call.

10.2 Using the Phonebook to Dial a Telephone Number

Use the following instructions to use one of the Prestige's existing phonebook entries to make a call.

- 1 Press the **Right** key to enter the Prestige book.
- 2 Use the up or down arrow button to choose the name.
- 3 Press the **Call** key to dial the number.

10.3 Using Speed Dial to Dial a Telephone Number

Press a speed dial entry's key for about two seconds to dial the entry.

10.4 Redialing a Telephone Number

- 4 In the standby mode, press the **Call** key.
- 5 A list of recently called telephone numbers displays.
- 6 Use the up or down arrow button to scroll through the list of telephone numbers.
- 7 Press the **Call** key to make the call.

10.5 Answering a Call

Press the **Call** key to answer a call.

10.6 Rejecting a Call

Press the **Off** key to reject a call.

10.7 Changing the Volume

Press the volume buttons to increase or decrease the volume during a call.

Use the web configurator's administrator account if you want to change the Prestige's default volume. See the web configurator sections for details.

CHAPTER 11

Using the Web Configurator Screens

This chapter describes how to use the Prestige's web configurator to view and configure the Prestige's settings.

11.1 Introduction to the Web Configurator

The embedded web configurator allows you to configure or view the Prestige's settings through Microsoft Internet Explorer. Use Internet Explorer 6.0 and later versions.

It is recommended that you set your screen resolution to 1024 by 768 pixels.

11.2 Accounts

The Prestige has two pre-configured accounts to access the web configurator. The first is the user account that lets you configure the Prestige's basic settings. The second is an administrator's account that allows you to alter the way the Prestige makes and receives calls, for example selecting a voice codec.

Note: Do not attempt to change the administrator settings unless you understand what you are doing. These settings affect the way your Prestige makes and receives calls and are already configured for best performance.

11.2.1 Login

- 1 Make sure your Prestige is connected to the wireless LAN and record its IP address (you can use the **Information** menu to check your phone's IP address).
- 2 Launch your web browser.
- 3 Type "http://<IP address>" as the URL (where "IP address" is the Prestige's IP address).

Figure 8 Browser Address



- 4 Enter your user name and password and click **OK** to login.

- For user access: Type the default user name: **admin** and password: **1234** for user-level access, the first time you login.
- For administrator access: Type the default user name: **zyxeladmin** and password: **1234** for administrator access, the first time you login.

Figure 9 Login Screen

Note: It is strongly advised that you change the passwords for both the user and administrator accounts the first time you login.

11.3 Navigating the Prestige Web Configurator

The following screen displays first when you use the user account.

Figure 10 Web Configurator First User Screen

The web configurator is divided into several screens. Click a link in the navigation panel (on the left side of the screen) to go to the corresponding screen.

The following table introduces the screens that are available with the user account.

Table 3 Web Configurator User Screens Summary

LINK	FUNCTION
Information	This screen contains firmware version information.
Network	Use this screen to configure your Internet access settings.
SIP	Use this screen to configure your Prestige's Session Initiation Protocol settings.
NAT TRVSL	Use this screen to configure your Prestige's NAT traversal settings.
PHONE BOOK	Use this screen to store and later retrieve names and corresponding telephone numbers.
Wireless	Use this screen to configure the wireless LAN settings.
System	Use this screen to change your password.or the Prestige's time.
S/W Update	Use this screen to upload an auto-provisioning configuration file or firmware to your Prestige.

The following screen displays first with administrator access.

Figure 11 Web Configurator First Administrator Screen



The following table introduces the screens that are available with administrator access (in addition to the screens available with user access).

Table 4 Web Configurator Administrator Screens Summary

LINK	FUNCTION
PHONE	Use this screen to configure your Prestige's phone settings.
TOS/DS	Use this screen to configure your Prestige's Type of Service and Differentiated Services settings.

CHAPTER 12

User Web Configurator Screens

This chapter details the settings that you can configure in the web configurator using the user account.

12.1 Device Information

Use this screen to view read-only information about your Prestige.

Figure 12 Device Information

DEVICE INFORMATION	
Software Version	VW.00.01
Bootrom Version	B.00.16
Release Date	Mar 14 2005

Table 5 Device Information

LABEL	DESCRIPTION
Software Version	This is the firmware version that the Prestige is using.
Bootrom Version	This is the boot ROM (Read Only Memory) firmware version that the Prestige is using.
Release Date	This is the date that the Prestige's firmware was released.

12.2 IP Address Assignment

Every computer on the Internet must have a unique IP address. If your networks are isolated from the Internet, for instance, only between your two branch offices, you can assign any IP addresses to the hosts without problems. However, the Internet Assigned Numbers Authority (IANA) has reserved the following three blocks of IP addresses specifically for private networks.

Table 6 Private IP Address Ranges

10.0.0.0	-	10.255.255.255
172.16.0.0	-	172.31.255.255
192.168.0.0	-	192.168.255.255

You can obtain your IP address from the IANA, from an ISP or have it assigned by a private network. If you belong to a small organization and your Internet access is through an ISP, the ISP can provide you with the Internet addresses for your local networks. On the other hand, if you are part of a much larger organization, you should consult your network administrator for the appropriate IP addresses.

Note: Regardless of your particular situation, do not create an arbitrary IP address; always follow the guidelines above. For more information on address assignment, please refer to RFC 1597, Address Allocation for Private Internets and RFC 1466, Guidelines for Management of IP Address Space.

12.3 IP Address and Subnet Mask

Similar to the way houses on a street share a common street name, so too do computers on a network share one common network number.

Where you obtain your network number depends on your particular situation. If the ISP or your network administrator assigns you a block of registered IP addresses, follow their instructions in selecting the IP addresses and the subnet mask.

If the ISP did not explicitly give you an IP network number, then most likely you have a single user account and the ISP will assign you a dynamic IP address when the connection is established. The Internet Assigned Number Authority (IANA) reserved this block of addresses specifically for private use; please do not use any other number unless you are told otherwise. Let's say you select 192.168.1.0 as the network number; which covers 254 individual addresses, from 192.168.1.1 to 192.168.1.254 (zero and 255 are reserved). In other words, the first three numbers specify the network number while the last number identifies an individual computer on that network.

Once you have decided on the network number, pick an IP address that is easy to remember, for instance, 192.168.1.1, for your Prestige, but make sure that no other device on your network is using that IP address.

The subnet mask specifies the network number portion of an IP address. Your Prestige will compute the subnet mask automatically based on the IP address that you entered. You don't need to change the subnet mask computed by the Prestige unless you are instructed to do otherwise.

12.4 MAC Address

Every Ethernet device has a unique MAC (Media Access Control) address. The MAC address is assigned at the factory and consists of six pairs of hexadecimal characters, for example, 00:A0:C5:00:00:02.

12.5 DNS Server

Use DNS (Domain Name System) to map a domain name to its corresponding IP address and vice versa, for instance, the IP address of www.zyxel.com is 204.217.0.2. The DNS server is extremely important because without it, you must know the IP address of a computer before you can access it.

The Prestige can get the DNS server addresses in the following ways.

- 1 The ISP tells you the DNS server addresses, usually in the form of an information sheet, when you sign up. If your ISP gives you DNS server addresses, manually enter them in the DNS server fields.
- 2 You can manually enter the IP addresses of other DNS servers. These servers can be public or private.

12.6 Network Configuration: STATIC

If you were assigned a specific IP address for your Prestige, use the following directions to set your Prestige to use it.

Figure 13 STATIC Network Configuration

NETWORK CONFIGURATION	
Get IP Address	<input type="radio"/> STATIC <input type="radio"/> DHCP <input type="radio"/> PPPoE
Network Mode	STATIC
Network IP	<input type="text" value="192.168.1.3"/>
Network Subnet Mask	<input type="text" value="255.255.255.0"/>
Default Gateway	<input type="text" value="192.168.1.1"/>
MAC Address	00a0c5b76249
DNS Server IP	<input type="text" value="168.95.1.1"/>
Second DNS Server IP	<input type="text" value="139.175.55.244"/>
	<input type="button" value="APPLY"/> <input type="button" value="CANCEL"/>

Table 7 STATIC

LABEL	DESCRIPTION
Get IP Address Network Mode	Click STATIC to manually enter a fixed IP address. Click DHCP to have the Prestige automatically obtain network settings at startup from a Dynamic Host Configuration Protocol server. These settings are not configurable. Click PPPoE if your ISP uses Point-to-Point Protocol over Ethernet.
Network IP	This is the IP address your Prestige uses to connect to the wireless LAN. Type the address given to you by your network administrator.
Network Subnet Mask	The subnet mask specifies the network number portion of an IP address. Type the subnet mask given to you by your network administrator. See the appendix for information on subnetting.
Default Gateway	Type the gateway IP address of the device to which your Prestige is to connect.
MAC Address	Every Ethernet device has a unique MAC (Media Access Control) address. The MAC address is assigned at the factory and consists of six pairs of hexadecimal characters, for example, 00:A0:C5:00:00:02. This field is read only and cannot be configured.
DNS Server IP	Type the DNS' IP address for translating readable domain names into valid computer IP addresses.
Second DNS Server IP	Type a backup DNS IP address for the Prestige to use in the event that the Prestige cannot connect to the preferred DNS.
APPLY	Click APPLY to save your changes without restarting the Prestige. Your wireless LAN, Internet and SIP settings changes do not take affect until you use RESTART (in the navigation panel).
CANCEL	Click CANCEL to begin configuring this screen afresh.

12.7 Network Configuration: DHCP

If you were not assigned a specific IP address for your Prestige, use the following directions to set your Prestige to get it automatically via DHCP (Dynamic Host Control Protocol).

Figure 14 DHCP Network Configuration

NETWORK CONFIGURATION	
Get IP Address	<input type="button" value="STATIC"/> <input checked="" type="button" value="DHCP"/> <input type="button" value="PPPoE"/>
Network Mode	DHCP
Network IP	192.168.1.33
Network Subnet Mask	255.255.255.0
Default Gateway	192.168.1.1
MAC Address	00a0c5b7814d
DNS Server IP	192.168.1.1
Second DNS Server IP	168.95.1.1
	<input type="button" value="APPLY"/> <input type="button" value="CANCEL"/>

Table 8 DHCP

LABEL	DESCRIPTION
Get IP Address	Click STATIC to manually enter a fixed IP address.
Network Mode	Click DHCP to have the Prestige automatically obtain network settings at startup from a Dynamic Host Configuration Protocol server. These settings are not configurable. Click PPPoE if your ISP uses Point-to-Point Protocol over Ethernet.
Network IP	This is the IP address your Prestige uses to connect to the wireless LAN.
Network Subnet Mask	The subnet mask specifies the network number portion of an IP address.
Default Gateway	This field displays the gateway IP address of the device to which your Prestige is to connect.
MAC Address	Every Ethernet device has a unique MAC (Media Access Control) address. The MAC address is assigned at the factory and consists of six pairs of hexadecimal characters, for example, 00:A0:C5:00:00:02. This field is read only and cannot be configured.
DNS Server IP	This field displays the IP address of the DNS server for translating readable domain names into valid computer IP addresses.
Second DNS Server IP	This field displays the IP address of the backup DNS server for the Prestige to use in the event that the Prestige cannot connect to the preferred DNS.
APPLY	Click APPLY to save your changes without restarting the Prestige. Your wireless LAN, Internet and SIP settings changes do not take affect until you use RESTART (in the navigation panel).
CANCEL	Click CANCEL to begin configuring this screen afresh.

12.8 Network Configuration: PPPoE

Point-to-Point Protocol over Ethernet (PPPoE) functions as a dial-up connection. PPPoE is an IETF (Internet Engineering Task Force) draft standard specifying how a host personal computer interacts with a broadband modem (for example DSL, cable, wireless, etc.) to achieve access to high-speed data networks.

Use the following screen to set your Prestige to use PPPoE for your Internet connection. You must have a user name (PPPoE username) and password from you ISP.

Figure 15 PPPoE Network Configuration

NETWORK CONFIGURATION	
Get IP Address	<input type="button" value="STATIC"/> <input type="button" value="DHCP"/> <input checked="" type="button" value="PPPoE"/>
Network Mode	PPPoE
Network IP	192.168.1.33
Network Subnet Mask	255.255.255.0
Default Gateway	192.168.1.1
PPPoE Username	<input type="text" value="pppoe_username"/>
PPPoE Password	<input type="text" value="pppoe_password"/>
MAC Address	00a0c5b7814d
DNS Server IP	192.168.1.1
Second DNS Server IP	168.95.1.1
<input type="button" value="APPLY"/> <input type="button" value="CANCEL"/>	

Table 9 PPPoE

LABEL	DESCRIPTION
Get IP Address	Click STATIC to manually enter a fixed IP address.
Network Mode	Click DHCP to have the Prestige automatically obtain network settings at startup from a Dynamic Host Configuration Protocol server. These settings are not configurable. Click PPPoE if your ISP uses Point-to-Point Protocol over Ethernet.
Network IP	This is IP address your Prestige uses to connect to the wireless LAN.
Network Subnet Mask	The subnet mask specifies the network number portion of an IP address.
Default Gateway	This field displays the gateway IP address of the device to which your Prestige is to connect.
PPPoE Username	Type the username given to you by your network administrator.
PPPoE Password	Type the password associated with the username above.

Table 9 PPPoE (continued)

LABEL	DESCRIPTION
MAC Address	Every Ethernet device has a unique MAC (Media Access Control) address. Your Prestige's MAC address is assigned at the factory and consists of six pairs of hexadecimal characters, for example, 00:A0:C5:00:00:02. This field is read only and cannot be configured.
DNS Server IP	This field displays the IP address of the DNS server for translating readable domain names into valid computer IP addresses.
Second DNS Server IP	This field displays the IP address of the backup DNS server for the Prestige to use in the event that the Prestige cannot connect to the preferred DNS.
APPLY	Click APPLY to save your changes without restarting the Prestige. Your wireless LAN, Internet and SIP settings changes do not take affect until you use RESTART (in the navigation panel).
CANCEL	Click CANCEL to begin configuring this screen afresh.

12.9 VoIP Introduction

VoIP (Voice over IP) is the sending of voice signals over the Internet Protocol. This allows you to make phone calls and send faxes over the Internet at a fraction of the cost of using the traditional circuit-switched telephone network. You can also use servers to run telephone service applications like PBX services and voice mail. Internet Telephony Service Provider (ITSP) companies provide VoIP service. A company could alternatively set up an IP-PBX and provide it's own VoIP service.

Circuit-switched telephone networks require 64 kilobits per second (kbps) in each direction to handle a telephone call. VoIP can use advanced voice coding techniques with compression to reduce the required bandwidth.

12.9.1 SIP

The Session Initiation Protocol (SIP) is an application-layer control (signaling) protocol that handles the setting up, altering and tearing down of voice and multimedia sessions over the Internet.

SIP signaling is separate from the media for which it handles sessions. The media that is exchanged during the session can use a different path from that of the signaling. SIP handles telephone calls and can interface with traditional circuit-switched telephone networks.

12.9.1.1 SIP Identities

A SIP account uses an identity (sometimes referred to as a SIP address). A complete SIP identity is called a SIP URI (Uniform Resource Identifier). A SIP account's URI identifies the SIP account in a way similar to the way an e-mail address identifies an e-mail account. The format of a SIP identity is SIP-Number@SIP-Service-Domain.

12.9.1.1.1 SIP Number

The SIP number is the part of the SIP URI that comes before the "@" symbol. A SIP number can use letters like in an e-mail address (johndoe@VoIP-provider.com for example) or numbers like a telephone number (1122334455@VoIP-provider.com for example).

12.9.1.1.2 SIP Service Domain

The SIP service domain of the VoIP service provider is the domain name in a SIP URI. For example, if the SIP address is 1122334455@VoIP-provider.com, then “VoIP-provider.com” is the SIP service domain.

12.9.1.2 SIP Call Progression

The following figure displays the basic steps in the setup and tear down of a SIP call. A calls B.

Table 10 SIP Call Progression

A		B
1. INVITE		
		2. Ringing
		3. OK
4. ACK		
	5. Dialogue (voice traffic)	
6. BYE		
		7. OK

- 1 A sends a SIP INVITE request to B. This message is an invitation for B to participate in a SIP telephone call.
- 2 B sends a response indicating that the telephone is ringing.
- 3 B sends an OK response after the call is answered.
- 4 A then sends an ACK message to acknowledge that B has answered the call.
- 5 Now A and B exchange voice media (talk).
- 6 After talking, A hangs up and sends a BYE request.
- 7 B replies with an OK response confirming receipt of the BYE request and the call is terminated.

12.9.1.3 SIP Client Server

SIP is a client-server protocol. A SIP client is an application program or device that sends SIP requests. A SIP server responds to the SIP requests.

When you use SIP to make a VoIP call, it originates at a client and terminates at a server. A SIP client could be a computer or a SIP phone. One device can act as both a SIP client and a SIP server.

12.9.1.3.1 SIP User Agent

A SIP user agent can make and receive VoIP telephone calls. This means that SIP can be used for peer-to-peer communications even though it is a client-server protocol. In the following figure, either A or B can act as a SIP user agent client to initiate a call. A and B can also both act as a SIP user agent to receive the call.

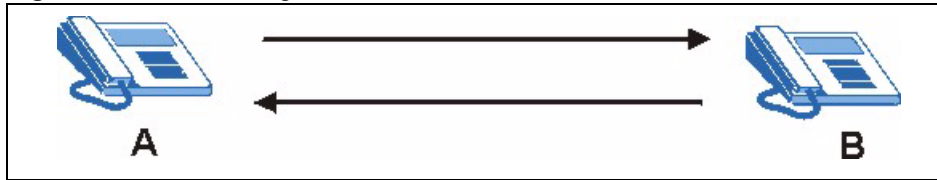
Figure 16 SIP User Agent

12.9.1.3.2 SIP Proxy Server

A SIP proxy server receives requests from clients and forwards them to another server. In the following example, you want to use client device A to call someone who is using client device C.

- 1 The client device (A in the figure) sends a call invitation to the SIP proxy server (B).
- 2 The SIP proxy server forwards the call invitation to C.

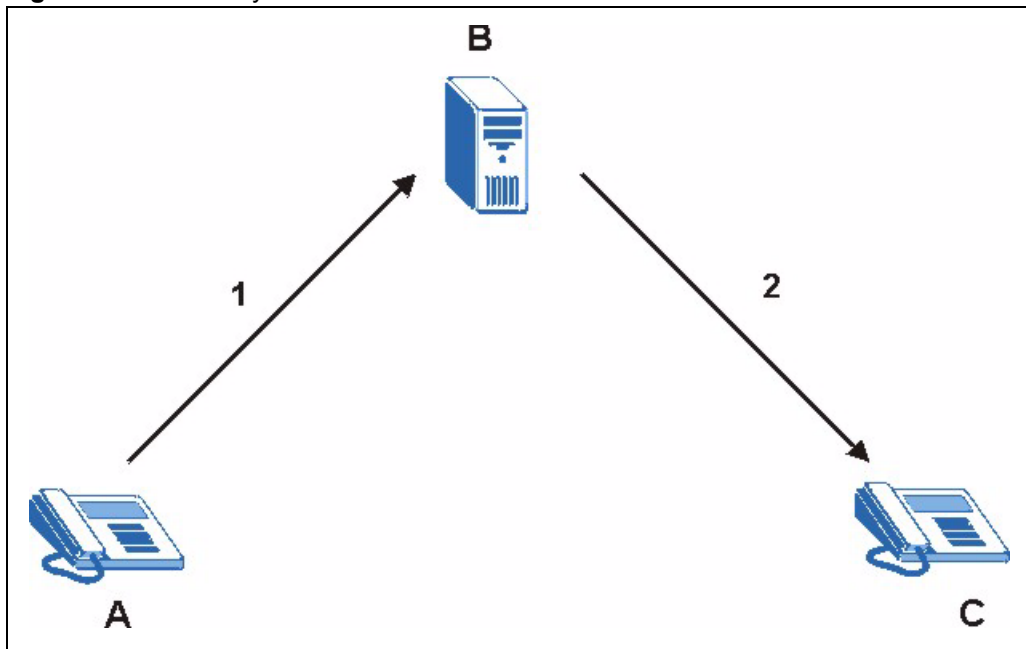
Figure 17 SIP Proxy Server

12.9.1.3.3 SIP Redirect Server

A SIP redirect server accepts SIP requests, translates the destination address to an IP address and sends the translated IP address back to the device that sent the request. Then the client device that originally sent the request can send requests to the IP address that it received back from the redirect server. Redirect servers do not initiate SIP requests.

In the following example, you want to use client device A to call someone who is using client device C.

- 1 Client device A sends a call invitation for C to the SIP redirect server (B).
- 2 The SIP redirect server sends the invitation back to A with C's IP address (or domain name).
- 3 Client device A then sends the call invitation to client device C.

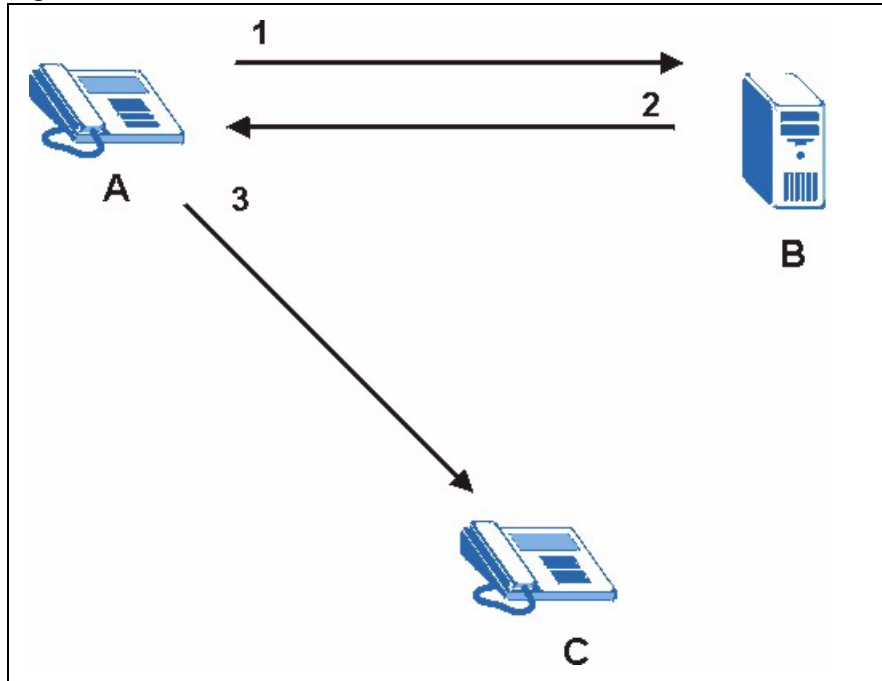
Figure 18 SIP Redirect Server

12.9.1.3.4 SIP Register Server

A SIP register server maintains a database of SIP identity-to-IP address (or domain name) mapping. The register server checks your user name and password when you register.

12.9.1.4 RTP

When you make a VoIP call using SIP, the RTP (Real time Transport Protocol) is used to handle voice data transfer. See RFC 1889 for details on RTP.

12.10 SIP Configuration

Your Prestige is a SIP client and must connect to a SIP server. The SIP proxy server receives your Prestige's SIP requests and forwards them to the next SIP server in the network.

Figure 19 SIP

SIP PROXY	
Proxy IP Address	192.168.0.3
User Account	
Registrar Username	username
Local Name	NULL
Phone Number	100
Registration Status	Not Registered

Table 11 SIP

LABEL	DESCRIPTION
SIP PROXY	
Proxy IP Address	This field displays the IP address or domain name of your SIP proxy server.
User Account	
Registrar Username	This field displays the username as supplied by your VoIP provider to access the SIP server.
Local Name	This field displays the name used to interoperate with other SIP devices and identify your Prestige on a network.
Phone Number	This field displays your telephone number as your VoIP provider gave you.
Registration Status	This field displays either Registered or Not Registered depending on the success of your Prestige's connection to the SIP-Server.

12.11 NAT

NAT (Network Address Translation - NAT, RFC 1631) is the translation of the IP address of a host in a packet. For example, the source address of an outgoing packet, used within one network is changed to a different IP address known within another network.

In the simplest form, NAT changes the source IP address of a packet received from a device to another IP address before forwarding the packet towards the destination. When the response comes back, NAT translates the destination address back to the device's IP address and forwards it to the device.

NAT routers are commonly used to translate private (or internal) IP addresses in packet headers to public (or external) IP addresses and vice versa. A NAT router maps a private IP address and port pair to a public IP address and port, and whenever the NAT router receives a packet with that public IP address and port, it knows how to reroute the packet back to the private IP address and port.

12.11.1 NAT Example

See the following figure. The Prestige (X) sends packets to the Internet. The Prestige's IP address is 10.0.0.3 (a private IP address). The NAT router maps the private source IP address to a public source IP address (a.b.c.d).

Note: The NAT figures in this chapter use lower-case letters (like a.b.c.d for example) to represent public IP addresses.

Figure 20 NAT: Outgoing

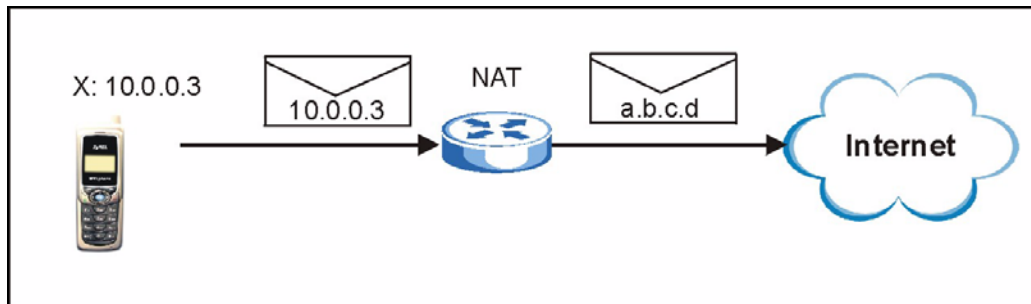

When the NAT router receives packets with destination address IP address a.b.c.d, the NAT router changes a.b.c.d back to the private IP address 10.0.0.3 and sends it to the Prestige.

Figure 21 NAT: Incoming

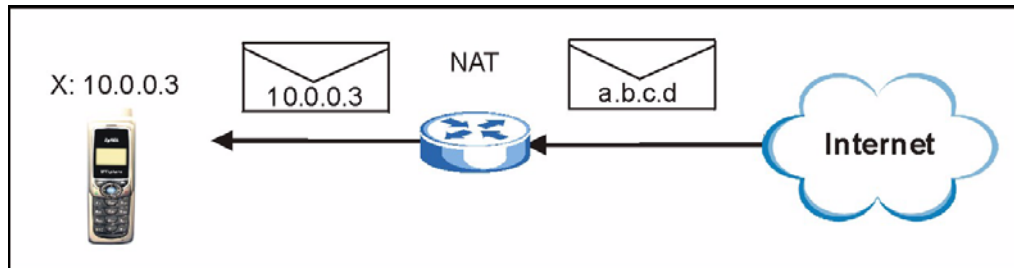

12.11.2 NAT Types

This section discusses the following NAT types that may be implemented on a router in front of the Prestige.

- Full Cone
- Restricted Cone
- Port Restricted Cone
- Symmetric

The following table summarizes how these NAT types handle outgoing and incoming packets. Read the following sections for more details and examples.

Table 12 NAT Types

	FULL CONE	RESTRICTED CONE	PORT RESTRICTED CONE	SYMMETRIC
Incoming Packets	Any external host can send packets to the mapped external IP address and port.	Only external hosts with an IP address to which the internal host has already sent a packet can send packets to the mapped external IP address and port.	Only external hosts with an IP address and port to which the internal host has already sent a packet can send packets to the mapped external IP address and port.	A host on the external network can only send packets to the specific mapped external IP address and port that the NAT router used in sending a packet to the external host's IP address and port.
Outgoing Packets	The NAT router maps the internal IP address and port of all outgoing packets to a single IP address and port on the external network.			The NAT router maps the internal IP address and port of each outgoing packet to a different external IP address and port for each different destination IP address and port.

The examples in these NAT type sections describe NAT translation between internal (private) and external (public) IP addresses.

12.11.2.1 Full Cone NAT

In full cone NAT, the NAT router maps all outgoing packets from an internal IP address and port to a single IP address and port on the external network. The NAT router also maps packets coming to that external IP address and port to the internal IP address and port.

In the following example, the NAT router maps the source address of all packets sent from the Prestige's internal IP address **1** and port **A** to IP address **2** and port **B** on the external network. The NAT router also performs NAT on all incoming packets sent to IP address **2** and port **B** and sends them to IP address **1**, port **A**.

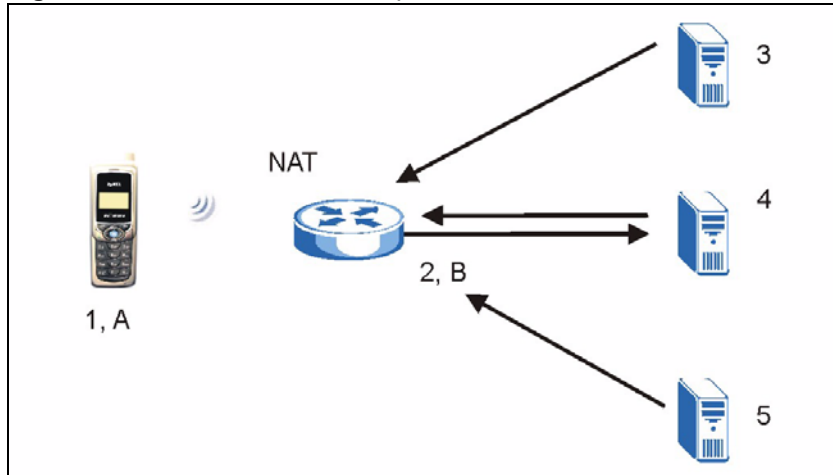
Figure 22 Full Cone NAT Example

12.11.2.2 Restricted Cone NAT

As in full cone NAT, a restricted cone NAT router maps all outgoing packets from an internal IP address and port to a single IP address and port on the external network. In the following example, the NAT router maps the source address of all packets sent from internal IP address **1** and port **A** to IP address **2** and port **B** on the external network.

The difference from full cone NAT is in how the restricted cone NAT router handles packets coming in from the external network. A host on the external network (IP address **3** or IP address **4** for example) can only send packets to the internal host if the internal host has already sent a packet to the external host's IP address.

A Prestige with IP address **1** and port **A** sends packets to IP address **3** and IP address **4**. The NAT router changes the Prestige's IP address to **2** and port to **B**.

Both **4, D** and **4, E** can send packets to **2, B** since **1, A** has already sent packets to **4**. The NAT router will perform NAT on the packets from **4, D** and **4, E** and send them to the Prestige at IP address **1**, port **A**. Packets have not been sent from **1, A** to **3** or **5**, so **3** and **5** cannot send packets to **1, A**.

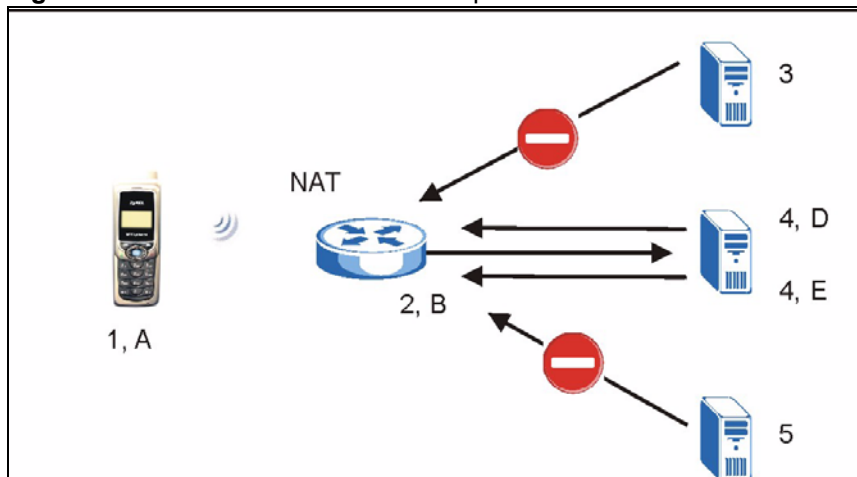
Figure 23 Restricted Cone NAT Example

12.11.2.3 Port Restricted Cone NAT

As in full cone NAT, a port restricted cone NAT router maps all outgoing packets from an internal IP address and port to a single IP address and port on the external network. In the following example, the NAT router maps the source address of all packets sent from internal IP address **1** and port **A** to IP address **2** and port **B** on the external network.

The difference from full cone and restricted cone NAT is in how the port restricted cone NAT router handles packets coming in from the external network. A host on the external network (IP address **3** and Port **C** for example) can only send packets to the internal host if the internal host has already sent a packet to the external host's IP address and port.

A Prestige with IP address **1** and port **A** sends packets to IP address **3**, port **C** and IP address **4**, port **D**. The NAT router changes the Prestige's IP address to **2** and port to **B**.

Since **1, A** has already sent packets to **3, C** and **4, D**, they can send packets back to **2, B** and the NAT router will perform NAT on them and send them to the Prestige at IP address **1**, port **A**.

Packets have not been sent from **1, A** to **4, E** or **5**, so they cannot send packets to **1, A**.

Figure 24 Port Restricted Cone NAT Example

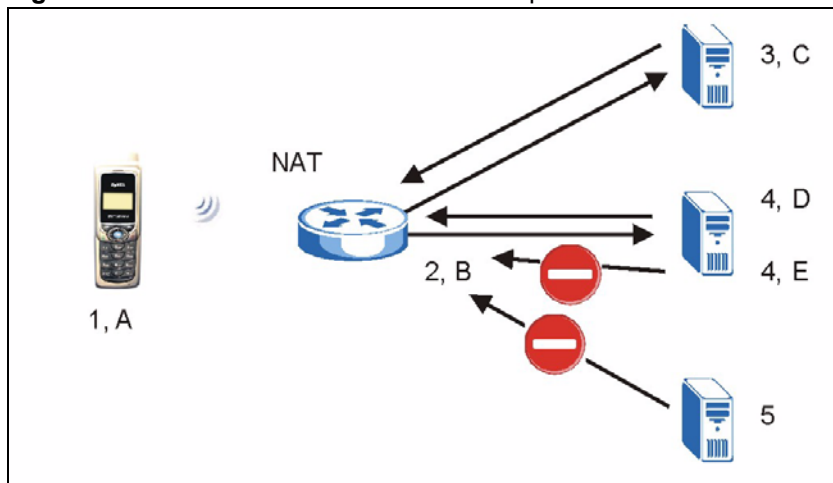

12.11.2.4 Symmetric NAT

The full, restricted and port restricted cone NAT types use the same mapping for an outgoing packet's source address regardless of the destination IP address and port. In symmetric NAT, the mapping of an outgoing packet's source address to a source address in another network is different for each different destination IP address and port.

In the following example, the NAT router maps the Prestige's source address IP address **1** and port **A** to IP address **2** and port **B** on the external network for packets sent to IP address **3** and port **B**. The NAT router uses a different mapping (IP address **2** and port **M**) when the Prestige sends packets to IP address **4** and port **D**.

A host on the external network (IP address **3** and port **C** for example) can only send packets to the internal host via the external IP address and port that the NAT router used in sending a packet to the external host's IP address and port. So in the example, only **3, C** is allowed to send packets to **2, B** and only **4, D** is allowed to send packets to **2, M**.

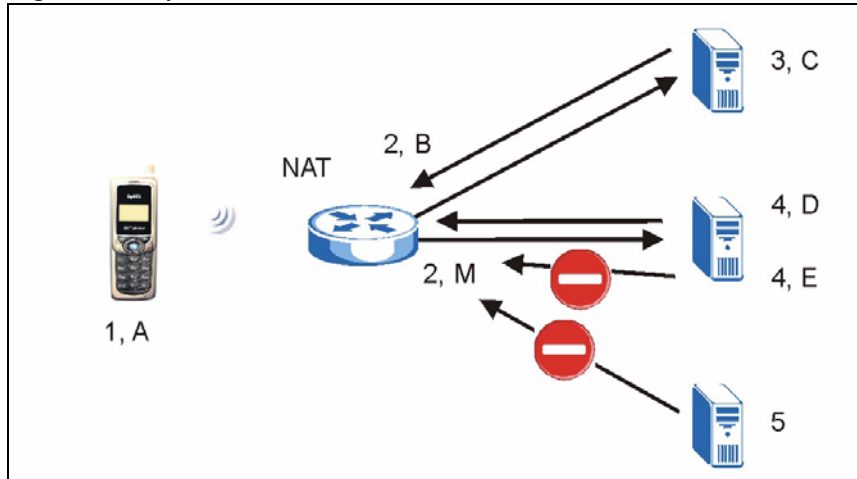
Figure 25 Symmetric NAT

12.12 NAT and SIP

Some NAT routers are not SIP-friendly and will stop your voice sessions.

The Prestige must register its public IP address with a SIP register server. If there is a NAT router between the Prestige and the SIP register server, the Prestige probably has a private IP address. The Prestige lists its IP address in the SIP message that it sends to the SIP register server. NAT does not translate this IP address in the SIP message. The SIP register server gets the Prestige's IP address from inside the SIP message and maps it to your SIP identity. If the Prestige has a private IP address listed in the SIP message, the SIP server cannot map it to your SIP identity.

A SIP ALG (Application Layer Gateway), the fake WAN address on SIP and RTP, STUN, or outbound proxy features allow the Prestige to use its public IP address in the SIP messages.

12.12.1 SIP ALG

Some NAT routers may include a SIP Application Layer Gateway (ALG). A SIP ALG allows SIP calls to pass through NAT by examining and translating IP addresses embedded in the data stream. When the Prestige registers with the SIP register server, the SIP ALG translates the Prestige's private IP address inside the SIP data stream to a public IP address. You do not need to use STUN or an outbound proxy if your Prestige is behind a SIP ALG.

12.12.2 Fake WAN Address on SIP and RTP

If you know the NAT router's public IP address and SIP port number, you can use the fake WAN address on SIP and RTP feature to manually configure the Prestige to use a them in the SIP messages. This eliminates the need for STUN or a SIP ALG.

You must also configure the NAT router to forward traffic with the SIP port number to the Prestige.

12.12.3 STUN

STUN (Simple Traversal of User Datagram Protocol (UDP) through Network Address Translators) allows the Prestige to find the presence and types of NAT routers and/or firewalls between it and the public Internet. STUN also allows the Prestige to find the public IP address that NAT assigned, so the Prestige can embed it in the SIP data stream. STUN does not work with symmetric NAT routers (see [Section 12.11.2.4 on page 87](#)) or firewalls. See RFC 3489 for details on STUN.

The following figure shows how STUN works.

- 1 The Prestige (A) sends SIP packets to the STUN server.
- 2 The STUN server finds the public IP address and port number that the NAT router used on the Prestige's SIP packets and sends them to the Prestige.
- 3 The Prestige uses the public IP address and port number in the SIP packets that it sends to the SIP server.

Figure 26 STUN

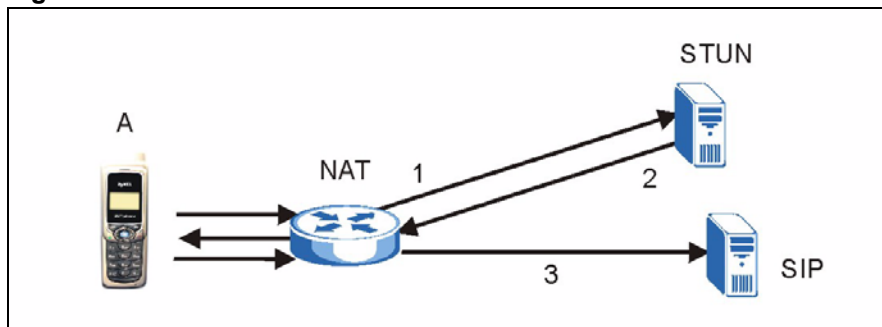

12.12.4 Outbound Proxy

Your VoIP service provider may host a SIP outbound proxy server to handle all of the Prestige's VoIP traffic. This allows the Prestige to work with any type of NAT router and eliminates the need for STUN or a SIP ALG. Turn off a SIP ALG on a NAT router in front of the Prestige to keep it from retranslating the IP address (since this is already handled by the outbound proxy server).

12.13 NAT Traversal Configuration

Click **NAT TRVSL** to open the following screen where you can configure your Prestige to operate through a NAT router that is not SIP-friendly.

The following screen displays the IP address and port number of an outbound proxy server the Prestige uses to connect to the outbound proxy server.

Figure 27 NAT Traversal Configuration

NAT TRAVERSAL

Select Type None ▾

Outbound Proxy

Outbound Proxy Server Address 192.168.0.191
 Outbound Proxy Server Port 5060

STUN (RFC3489)

STUN Server IP 192.168.0.191 : 3478
 STUN Interval(sec.) 200

Fake WAN Address on SIP and RTP

WAN IP Address 192.168.0.3
 WAN SIP Port 5060

Table 13 NAT Traversal Configuration

LABEL	DESCRIPTION
Select Type	<p>Select None if the Prestige is not behind a NAT router or the NAT router is a SIP ALG.</p> <p>Select By Outbound Proxy if your VoIP service provider has a SIP outbound server to handle voice calls. This allows the Prestige to work with any type of NAT router. Turn off a SIP ALG on a NAT router in front of the Prestige to keep it from retranslating the IP address (since this is already handled by the outbound proxy server).</p> <p>Select STUN if there is a NAT router between the Prestige and the VoIP service provider's SIP server and your VoIP service provider hosts a STUN server.</p> <p>Select Fake WAN Address on SIP and RTP to use a NAT router's public IP address and SIP port number in the Prestige's SIP messages. You must also configure the NAT router to forward traffic with this port number to the Prestige.</p>
Outbound Proxy	
Outbound Proxy Server Address	This field displays the IP address or domain name of your outbound proxy server.
Outbound Proxy Server Port	This field displays the port number to access proxy services.
STUN (RFC3489)	

Table 13 NAT Traversal Configuration (continued)

LABEL	DESCRIPTION
STUN Server IP	Type the IP address or domain name of the STUN server in the first field. You can use up to 127 ASCII characters. Enter the STUN server's listening port for STUN requests in the second field. Leave this field set to the default if your VoIP service provider did not give you a server port number for STUN.
STUN Interval(sec.)	Type how often the Prestige should check the STUN server to determine the correct public IP address to use.
Fake WAN Address on SIP and RTP	
WAN IP Address	Enter the NAT router's public IP address or domain name (up to 127 ASCII characters) in this field.
WAN SIP Port	Enter the port number that your SIP sessions use with the public IP address of the NAT router.
APPLY	Click APPLY to save your changes without restarting the Prestige. Your wireless LAN, Internet and SIP settings changes do not take affect until you use RESTART (in the navigation panel).
CANCEL	Click CANCEL to begin configuring this screen afresh.

12.14 Phonebook

Use the phonebook feature to store and later retrieve names and corresponding telephone numbers.

12.14.1 Calling Methods

The Prestige can dial a telephone number by using the SIP proxy server or an IP address.

- Select **Proxy** to have the SIP server make the connection.
- Select **P2P** to an IP address to place a call without first going through the SIP proxy server. This is called an IP to IP (or peer to peer) call. You need to enter the IP address of the callee or another SIP proxy server.

12.15 Phonebook Configuration

Click **PHONE BOOK** to open the following screen.

Figure 28 Phonebook

The screenshot shows a web interface for a phonebook. At the top, it says 'PHONEBOOK'. Below that is a section for 'Add New Entry' with several input fields: 'Speed Dial' (a dropdown menu with 'None' selected), 'Display Name' (a text box), 'User Info' (a text box with 'sip:' followed by another text box), 'Host IP' (a text box with '@' followed by another text box), 'Port' (a text box), and 'Service' (radio buttons for 'Proxy' and 'P2P', with 'Proxy' selected). An 'ADD' button is to the right. Below this is a table of existing entries:

Speed Dial	Name	Phone No.	Service	DELETE	EDIT
None	A	<sip:1234@192.168.0.3:5060>	Proxy	DELETE	EDIT
None	B	<sip:5678@1.1.1.1>	P2P	DELETE	EDIT

At the bottom of the table is a 'CLEAR' button.

Table 14 Phonebook

LABEL	DESCRIPTION
Add New Entry	
Speed Dial	Select a speed dial key combination from the drop-down list box if you want to use the speed dial function with this phonebook entry.
Display Name.	Enter a descriptive name to identify the party that you will use this entry to call.
User Info	Enter the SIP number of the party that you will call (use the number or text that comes before the @ symbol in a full SIP URI).
Host IP	Enter the SIP server's or the callee's IP address or domain name. Leave this blank if you will use the SIP proxy server to call this number.
Port	Enter the SIP server's or the callee's listening port for SIP in this field.
Destination	Select Proxy if calls to this party use your SIP account. Select P2P if calls to this party use a different SIP server or go directly to the callee's VoIP phone (peer-to-peer).
Add	Click this button to add a new entry into the Prestige's phonebook.
Phonebook	
Speed Dial	This is the entry's speed dial key combination (if it has one). Press this key combination on the Prestige to call the party named in this entry.
Name.	This field displays the name associated with a telephone number.
Phone No.	This field displays the telephone number of a contact in your telephone book.
Service	This displays Proxy for an entry that uses your SIP account. P2P displays for an entry that uses a different SIP server or goes directly to the callee's VoIP phone (peer-to-peer).
DELETE	Click this button to remove a phonebook entry.
EDIT	Click this button to change the phonebook entry. The entry displays in the Add New Entry section of the screen where you can edit it.
CLEAR	Click CLEAR to erase all of your phonebook entries.

12.16 Wireless Introduction

A wireless LAN can be as simple as two wireless devices communicating in a peer-to-peer network or as complex as a number of wireless devices communicating through access points which bridge network traffic to the wired LAN.

Note: See the WLAN appendix for more detailed information on WLANs.

12.16.1 WEP Encryption

WEP encryption scrambles the data transmitted between the wireless stations and the access points to keep network communications private. It encrypts unicast and multicast communications in a network. Both the wireless stations and the access points must use the same WEP key.

You need to configure four 64-bit or 128-bit WEP keys but only one key can be enabled at any one time.

In order to configure and enable WEP encryption; click **Wireless LAN** and **Wireless** to the display the **Wireless** screen.

12.17 Wireless Settings

When you turn the Prestige on, it searches for available wireless LAN Access Points (APs). It selects the AP with the best signal and restarts and attempts to connect to it.

Click **Wireless** to open the following screen if you want to enter a WEP key or manually specify other wireless settings.

Note: Your wireless LAN settings changes do not take affect until you use **RESTART** (in the navigation panel).

Note: Changing the wireless settings (especially the SSID or WEP settings) may disconnect your web configurator session since you connect wirelessly to the web configurator.

Figure 29 Wireless Setting

WIRELESS SETTINGS

Wireless Mode: 802.11b_AdHoc Infrastructure

SSID:

Channel(1-11):

Rate: Auto 1M 2M 5.5M 11M

WEP: 128bits

Authentication Type: Open System Shared Key

Key1:

Key2:

Key3:

Key4:

Default Key: Key1

APPLY
CANCEL

Table 15 Wireless Setting

LABEL	DESCRIPTION
Wireless Mode	An 802.11b_AdHoc network is the simplest WLAN configuration, defined as two or more wireless devices within range of each other that form an independent network without the need of an access point (AP). Select Infrastructure to access an AP.
SSID	(Service Set ID) The SSID identifies the Service Set with which a wireless station is associated. Wireless stations associating to the access point (AP) must have the same SSID. You can think of the SSID as being similar to a workgroup name in a Microsoft network.
Channel(1-11)	A channel is a radio frequency used by IEEE 802.11b wireless devices. Channels available depend on the AP to which you connect. The channel is determined automatically using the site survey feature.
Rate	The closer you are to an AP the stronger the signal and the faster the connection. Choose Auto to have the Prestige determine the best setting for your connection type.
WEP	If you are using a public AP, select None . Select the length of WEP keys (64bits or 128bits) that the AP uses. You must configure a WEP encryption key if the AP uses WEP.
Key 1 ~ 4	The WEP keys are used to encrypt data. Both the Prestige and the AP must use the same WEP key. If you chose 64-bit WEP, then enter 5 ASCII characters or 10 hexadecimal characters ("0-9", "A-F"). If you chose 128-bit WEP, then enter 13 ASCII characters or 26 hexadecimal characters ("0-9", "A-F"). You must configure all four keys, but only one key can be activated at any one time. The default key is Key 1 .

Table 15 Wireless Setting (continued)

LABEL	DESCRIPTION
Default Key	Choose from the available WEP keys. Leave Key 1 as the default key unless your network administrator tells you to do otherwise.
APPLY	Click APPLY to save your changes without restarting the Prestige. Your wireless LAN, Internet and SIP settings changes do not take affect until you use RESTART (in the navigation panel).
CANCEL	Click CANCEL to begin configuring this screen afresh.

12.18 System

Use this screen to set up the user account's user name and password, and configure the Prestige's time setting.

Figure 30 System

The screenshot shows a web-based configuration interface for the 'SYSTEM' section. It features a title bar with the word 'SYSTEM'. Below the title bar, there are four rows of input fields. The first row is 'Login Username' with the text 'admin' entered. The second row is 'New Password' with an empty field. The third row is 'Confirm Password' with an empty field. The fourth row is 'Edit Time' with the value '04 : 15' and a range '(HH: 00~23 MM: 00~59)'. At the bottom of the form, there are two buttons: 'APPLY' and 'CANCEL'.

Table 16 System

LABEL	DESCRIPTION
Login Username	Type in a name for regular user access. The default setting for this is "admin"
New Password	Type in a password. The default password for this setting is "1234"
Confirm Password	Type the new password again in this field.
Edit Time	Type the new time for the Prestige to display.
SUBMIT	Click SUBMIT to have the Prestige update to your new settings.
APPLY	Click APPLY to save your changes without restarting the Prestige.
CANCEL	Click CANCEL to begin configuring this screen afresh.

12.19 S/W Update

Click **S/W Update** to upload a new configuration or firmware file to your Prestige.

Figure 31 S/W Update

UPDATE

Auto-provisioning by HTTP

Update Firmware

Update Firmware by Web Browser

Update firmware by Web Server

Table 17 S/W Update

LABEL	DESCRIPTION
Auto-provisioning by HTTP	If there is an HTTP server set up to update the Prestige's configuration through auto-provisioning, type its IP address or domain name in this field. Click APPLY to have the Prestige check the server for the latest auto-provisioning file.
Update Firmware	
Update Firmware by Web Browser	Type in the location of the firmware file you want to upload in this field or click Browse ... to find it. Note: Remember that you must decompress compressed (.zip) files before you can upload them.
Update Firmware by Web Server	Type the location of a firmware file (on an HTTP server) that you want to upload in this field. Your network administrator or service provider must have an HTTP server set up with the firmware file in order for you to use this.
Browse	Click Browse... to find the file you want to upload.
Update	Click this button to begin the upload process. This process may take up to two minutes. The Prestige automatically restarts after you update the firmware. Note: Do not turn off the device or change it's configuration while firmware upload is in progress!

CHAPTER 13

Administrator Web Configurator Screens

This chapter details the Prestige's web configurator settings that can only be configured using the administrator account. Only edit these settings if you understand the technology involved.

Note: See [Chapter 12 on page 73](#) for information on the fields that can be configured through the user account.

13.1 NAT Traversal Configuration

Click **NAT TRVSL** to open the following screen. Administrator access allows you to configure the outbound proxy server address and port. If your ISP gave you an outbound proxy server address and port then enter them here.

Figure 32 NAT Traversal Configuration

NAT TRAVERSAL	
Select Type	None
Outbound Proxy	
Outbound Proxy Server Address	192.168.0.191
Outbound Proxy Server Port	5060
STUN (RFC3489)	
STUN Server IP	192.168.0.191 : 3478
STUN Interval(sec.)	200
Fake WAN Address on SIP and RTP	
WAN IP Address	192.168.0.3
WAN SIP Port	5060
<input type="button" value="APPLY"/> <input type="button" value="CANCEL"/>	

Table 18 NAT Traversal Configuration

LABEL	DESCRIPTION
Outbound Proxy	
Outbound Proxy Server Address	Type in the URL or IP address of your main outbound proxy server. This field is the destination address where your Prestige's SIP traffic is sent.
Outbound Proxy Server Port	Type in the port number to access proxy services.
APPLY	Click APPLY to save your changes without restarting the Prestige. Your wireless LAN, Internet and SIP settings changes do not take affect until you use RESTART (in the navigation panel).
CANCEL	Click CANCEL to begin configuring this screen afresh.

13.2 SIP Proxy Configuration

Your Prestige is a SIP client and must connect to a SIP server. The SIP proxy server receives your Prestige's SIP requests and forwards them to the next SIP server in the network.

Click **SIP** to open the following screen where you can set up your Prestige to connect to the SIP server.

Note: Enter either the IP address of your SIP server or the URL domain name as given to you by your VoIP service provider.

Figure 33 SIP Configuration

SIP PROXY	
SIP URI	sip: <input type="text" value="100"/> @ 192.168.0.3 : 5060
SIP Server Address	<input type="text" value="192.168.0.3"/>
SIP Server Port	<input type="text" value="5060"/>
Registrar Server Address	<input type="text" value="192.168.0.3"/>
Registrar Server Port	<input type="text" value="5060"/>
Register Expiry Time(sec.)	<input type="text" value="300"/>
OPTIONS Interval Timer	<input type="text" value="0"/>
Session Expiry Time(sec.)	<input type="text" value="0"/>
Display Name	<input type="text" value="NULL"/>
Authentication	
Registrar Username	<input type="text" value="username"/>
Registrar Password	<input type="password" value="*****"/>
Registration Status	Not Registered
<input type="button" value="APPLY"/> <input type="button" value="CANCEL"/>	

Table 19 SIP Configuration

LABEL	DESCRIPTION
SIP Proxy	
SIP URI	Type the SIP telephone number assigned to your Prestige by your VoIP service provider.
SIP Server Address	Type the IP address or domain name of the SIP server in this field. It doesn't matter whether the SIP server is a proxy, redirect or register server. You can use up to 95 ASCII characters.
SIP Server Port	Enter the SIP server's listening port for SIP in this field. Leave this field set to the default if your VoIP service provider did not give you a server port number for SIP.

Table 19 SIP Configuration (continued)

LABEL	DESCRIPTION
Registrar Server Address	Enter the SIP register server's IP address or domain name in this field. You can use up to 95 ASCII characters. Note: If you were not given a register server address, then enter the address from the SIP Server Address field again here.
Registrar Server Port	Enter the SIP register server's listening port for SIP in this field. Note: If you were not given a register server port, then enter the port from the SIP Server Port field again here.
Register Expiry Time (sec.)	This field sets how long an entry remains registered with the SIP register server. After this time period expires, the SIP register server deletes the Prestige's entry from the database of registered SIP numbers. The register server can use a different time period. The Prestige sends another registration request after half of this configured time period has expired.
OPTIONS Interval Timer	The OPTIONS Interval Timer periodically sends a signal to the SIP proxy server to maintain the connection. Type a time in minutes to send a KeepAlive signal to the SIP proxy server. The default is 0, which disables this feature.
Session Expiry Time (sec.)	Use this field to set the longest time that the Prestige will allow a SIP session to remain idle (without traffic) before dropping it.
Display Name	Type a name to interoperate with other SIP devices. It is recommended to leave the default setting for this field.
SIP Service Domain	Enter the SIP service domain name in this field (the domain name that comes after the @ symbol in a full SIP URI). You can use up to 127 ASCII Extended set characters.
Authentication	
Registrar Username	Type in the username exactly as supplied by your VoIP service provider.
Registrar Password	Type in the password associated with the username above exactly as supplied by your VoIP service provider.
Registration Status	This displays either Registered or Not Registered depending on the success of your Prestige's connection to the SIP server.
APPLY	Click APPLY to save your changes without restarting the Prestige. Your wireless LAN, Internet and SIP settings changes do not take affect until you use RESTART (in the navigation panel).
CANCEL	Click CANCEL to begin configuring this screen afresh.

13.3 Voice Coding

A codec (coder/decoder) codes analog voice signals into digital signals and decodes the digital signals back into voice signals. The Prestige supports the following codecs.

13.3.1 G.711

G.711 is a Pulse Code Modulation (PCM) waveform codec. G.711 provides very good sound quality but requires 64kbps of bandwidth.

Pulse Code Modulation (PCM) measures analog signal amplitudes at regular time intervals and converts them into bits.

13.3.2 G.729

G.729 is an Analysis-by-Synthesis (AbS) hybrid waveform codec that uses a filter based on information about how the human vocal tract produces sounds. G.729 provides good sound quality and reduces the required bandwidth to 8kbps.

13.4 PSTN Call Setup Signaling

PSTNs (Public Switched Telephone Network)s use DTMF or pulse dialing to set up telephone calls.

(Dual-Tone MultiFrequency (DTMF) signaling uses pairs of frequencies (one lower frequency and one higher frequency) to set up calls. It is also known as Touch Tone®. Each of the keys on a DTMF telephone corresponds to a different pair of frequencies.

Pulse dialing sends a series of clicks to the local phone office in order to dial numbers.¹

13.5 Phone Setting

Use this screen to configure the way your prestige handles telephone connections and codes voice-data.

Figure 34 PHONE

PHONE SETTINGS	
Default Voice Codec	G.729, 8k
Speaking Volume(-14~14)	5
Listening Volume(-14~14)	-5
RTP Port	2070
Jitter Buffer	<input type="radio"/> Small <input type="radio"/> Medium <input checked="" type="radio"/> Large
Voice Frames per Packet	<input type="radio"/> Small <input type="radio"/> Medium <input checked="" type="radio"/> Large
DTMF Relay	disable
DTMF Payload(0~127)	0
<input type="button" value="APPLY"/> <input type="button" value="CANCEL"/>	

1. The Prestige supports DTMF at the time of writing.

Table 20 PHONE

LABEL	DESCRIPTION
Default Voice Codec	<p>A voice codec (coder/decoder) converts voice data to electrical signals for transmission over a network.</p> <p>Use this field to select the type of voice coder/decoder (codec) that you want the Prestige to use. Choosing a voice codec depends on a tradeoff between transmission speed, sound quality and desired bandwidth usage. G.711 provides higher voice quality than G.729 but requires 64kbps of bandwidth while G.729 only requires 8kbps. The Prestige can only connect to other phones that use the same codec as the Prestige.</p> <p>If you want to use G.711, G.711u is used mainly in North America and G.711a is used in most of the rest of the world.</p>
Speaking Volume(-14~14)	<p>Select the default gain for the Prestige's microphone, where -14 is the minimum (least sensitive) and 14 is the maximum (most responsive).</p> <p>The callee may hear an echo if you set the microphone's volume to the maximum.</p>
Listening Volume(-14~14)	<p>Select the default speaker volume on the Prestige, where -14 is the minimum (quietest) and 14 is the maximum (loudest).</p>
RTP Port	<p>Real time Transport Protocol is used to handle voice data transfer. Use this field to configure the Prestige's listening port for RTP traffic. Leave this field set to the defaults if you were not given a RTP port to use.</p>
Jitter Buffer	<p>A larger receiving buffer allows the Prestige to rearrange data packets that arrive in the wrong order.</p> <p>Packets are dropped if they arrive out of order and the receiving buffer is full. Increasing the buffer size introduces latency. Too large of a buffer could introduce a significant delay with a slow connection. Too small of a buffer may result in packets being lost.</p>
Voice Frames per Packet	<p>Use smaller packet sizes to reduce the number of speech frames sent per packet. If a small packet does not reach its destination is it less significant than if the packet contained many speech frames.</p>
DTMF Relay	<p>Dual Tone Multi-Frequency signals are generated when you press a key on the Keypad and communicate information (such as telephone numbers) to the VoIP gateway.</p> <p>Select disable to send the DTMF digits uncompressed from the remaining protocols to use a compression method to match that of your VoIP service provider's.</p> <p>Select Inband(RFC 2833) to send the DTMF tones in RTP packets.</p> <p>Select Outband to send the DTMF tones in SIP messages.</p>
DTMF Payload (0-127)	<p>This field allows you to set the DTMF payload type. It is recommended to leave the default setting for this field.</p>
APPLY	<p>Click APPLY to save your changes without restarting the Prestige. Your wireless LAN, Internet and SIP settings changes do not take affect until you use RESTART (in the navigation panel).</p>
CANCEL	<p>Click CANCEL to begin configuring this screen afresh.</p>

13.6 System

Administrator access allows you to use this screen to set up the Prestige's administrator user name and password.

Figure 35 System Settings

SYSTEM	
Login Username	<input type="text" value="admin"/>
New Password	<input type="text"/>
Confirm Password	<input type="text"/>
Admin Login username	<input type="text" value="zyxeladmin"/>
Admin New Password	<input type="text"/>
Admin Confirm Password	<input type="text"/>
Edit Time	<input type="text" value="04"/> : <input type="text" value="47"/> (HH: 00~23 MM: 00~59)
<input type="button" value="APPLY"/> <input type="button" value="CANCEL"/>	

Table 21 System

LABEL	DESCRIPTION
Admin Login username	The default setting for this is "zyxeladmin".
Admin New Password	Type in a password. The default password is "1234"
Admin Confirm Password	Type the new password again in this field.
APPLY	Click APPLY to save your changes without restarting the Prestige. Your wireless LAN, Internet and SIP settings changes do not take affect until you use RESTART (in the navigation panel).
CANCEL	Click CANCEL to begin configuring this screen afresh.

13.7 Quality of Service

Quality of Service refers to both a network's ability to deliver data with minimum delay, and the networking methods used to provide bandwidth for real-time multimedia applications. Network traffic can be classified by setting the TOS (Type Of Service) values at the data source (for example, at the Prestige) so a server can decide the best method of delivery i.e. least cost, fastest route etc.

13.8 ToS

The second byte in an IPv4 packet is the Type of Service (ToS) byte. The first three bits (by themselves) of the ToS byte are referred to as the IP Precedence bits and refer to a priority from 0 to 7. The next three bits are used in conjunction with the IP Precedence bits to define the Diffserv Code Point protocol (DSCP bits). The last two bits are reserved for future use.

13.9 Introduction to DiffServ

Quality of Service (QoS) mechanisms provides the best service on a per-flow guarantee. To fine-tune the levels of services on the priority of the traffic flow using QoS places a heavy burden on the network infrastructure.

DiffServ is a class of service (CoS) model that marks packets so that they receive specific per-hop treatment at DiffServ-compliant network devices along the route based on the application types and traffic flow. Packets are marked with DiffServ Code Points (DSCPs) indicating the level of service desired. This allows the intermediary DiffServ-compliant network devices to handle the packets differently depending on the code points without the need to negotiate paths or remember state information for every flow. In addition, applications do not have to request a particular service or give advanced notice of where the traffic is going.

Note: It is strongly recommended for better network performance that the settings are left as per their defaults.

Figure 36 TOS/DIFFSERV

Table 22 TOS/DIFFSERV

LABEL	DESCRIPTION
ToS/DiffServ (00~FF)	Type the HEX code that represents the best method for data transmission.
APPLY	Click APPLY to save your changes without restarting the Prestige. Your wireless LAN, Internet and SIP settings changes do not take affect until you use RESTART (in the navigation panel).
CANCEL	Click CANCEL to begin configuring this screen afresh.

CHAPTER 14

Troubleshooting

This chapter covers potential problems and the corresponding remedies.

14.1 Problems Starting Up the Prestige

Table 23 Troubleshooting the Start-Up of Your Prestige

PROBLEM	CORRECTIVE ACTION
The Prestige does not turn on.	Make sure you have the battery installed and charged.
	Remove the Prestige's battery and reinstall it.
	If the error persists, you may have a hardware problem. In this case, you should contact your vendor.

14.2 Problems Using the Keypad

Table 24 Troubleshooting the Keypad

PROBLEM	CORRECTIVE ACTION
The Prestige is on but the keys do not work.	Press and hold the # key for approximately 2 seconds to lock or unlock the keypad.

14.3 Problems Accessing the Prestige



Table 25 Troubleshooting Accessing the Prestige

PROBLEM	CORRECTIVE ACTION
Cannot access the web configurator.	Make sure that you are connecting to the Prestige's IP address (you can use the Information LCD menu to check the IP address).
	<p>The username and password fields are case sensitive. Make sure that you enter the correct user name and password using the proper casing.</p> <p>If you have forgotten the user name and password, see Section 14.6 on page 107 to restore the factory default configuration file. This will restore all of the factory defaults including the user names and passwords.</p> <ul style="list-style-type: none"> • For user-level access the default user name is admin and the default password is 1234. • For administrator access the default user name is zyxeladmin and the default password is 1234.
	<p>You may also need to clear your Internet browser's cache.</p> <p>In Internet Explorer, click Tools and then Internet Options to open the Internet Options screen.</p> <p>In the General tab, click Delete Files. In the pop-up window, select the Delete all offline content check box and click OK. Click OK in the Internet Options screen to close it.</p>

14.4 Warning Message Troubleshooting

The Prestige displays warning messages when it detects a condition that may disrupt your Prestige service.



Table 26 Warning Message Troubleshooting

Warning Message	CORRECTIVE ACTION
Battery Low ( is blinking)	The battery's power is low. Recharge the battery.
Weak Signal ( is blinking)	<p>The signal quality is low or the Prestige cannot find the AP.</p> <p>Connect to another AP.</p> <p>Move your Prestige closer to the AP.</p> <p>There may be too much radio interference (for example a microwave or another AP using the same channel) around your wireless network. Relocate or reduce the radio interference.</p>

14.5 Error Message Troubleshooting

The Prestige displays error messages to let you know that an error has occurred. An error may prevent you from connecting to the network or from using the Prestige. For some of the error messages, you may need to contact the system administrator to resolve the problem.

Table 27 Error Message Troubleshooting

Error Message	CORRECTIVE ACTION
Battery Low ( is blinking)	The battery's power is low. Recharge the battery.
No AP Found ( is blinking)	The SSID set on the Prestige does not match any of the Service Set Identifiers (SSIDs) of the APs that are within range of the Prestige. Set the Prestige to a different SSID (you can use the site survey feature). Move your Prestige closer to the AP.
"Net Fail! (DHCP)"	The Prestige failed to obtain an IP address from a DHCP server. Make sure your wireless LAN settings are correct. Make sure the DHCP server is operating properly. Restart the Prestige.
"Net Fail! (PPPoE)"	The Prestige failed to obtain an IP address from the ISP. Make sure your PPPoE settings are correct. Restart the Prestige.
"Not Registered"	The Prestige failed to register with the SIP proxy server. It is still possible to place a direct IP to IP call without the SIP proxy server. You must create and use a phonebook entry (see Section 12.14 on page 91). Check your SIP settings. Contact your VoIP service provider.

14.6 Restoring the Factory Default Settings

Follow these directions to set the Prestige back to the factory default settings.

- 1 Turn the Prestige off.
- 2 Press the **Left** key and hold it down while you press the **On**
- 3 A message displays (see the following figure) indicating the Prestige has returned to the factory default settings.

Figure 37 Load Factory Default Settings

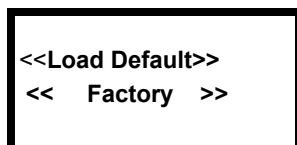

Appendix A

Product Specifications

See also the Introduction chapter for a general overview of the key features.

Specification Tables

Table 28 Hardware Specifications

Default Network Mode	DHCP client
Default User Account User name and Password	admin, 1234
Default Administrator Account Password	zyxeladmin, 1234
Dimensions	40 (W) x 128 (L) x 0.8(H) mm
LCD Module	112x64 Graphic Mode
LCD Backlight	4 blue LED
Keypad	12 number key, 8 function key
Keypad Light	Blue LED
Antenna	2.4GHz dipole, Gain: 1.3 dBi
Receiver & Speaker	Speaker: 85dB, 8 ohm Receiver: 116dB, 8 ohm
MIC	Sensitivity: -42dB \pm 3 dB, 100 HZ ~ 10K HZ
Codec	G.711/G.729a
Ear Jack	Jack for connecting a mono earphone and microphone headset (not included)
Operating Temperature	0° C ~ 40° C
Operating Voltage	3.03V \pm 5%, 1.8V \pm 5%
Battery	Li-ion 1350 mAh, UL and CE certifications
Charger	Seat type charger
Power Adaptor of Charger Seat	DC 5V 1.6A

Table 29 Firmware Features

Network	IP address assignment: Fixed IP, DHCP, PPPoE HTTP, TFTP, TCP, UDP, DNS, ARP, ICMP
Management	LCD screen menus Embedded Web Configurator Auto-provisioning: The Prestige acts as a HTTP client to receive configuration file from HTTP server automatically when booting up
Wireless	ESSID Channel ID configurable IEEE 802.11b Frequency Range: 2.4 GHz Wired Equivalent Privacy (WEP) Data Encryption 64/128 bit Site Survey Feature (Scan AP) Data Rates: 11 Mbps and Auto Fallback
Voice Features	SIP (Session Initiating Protocol, RFC 3261) version 2 SDP (Session Description Protocol, RFC2327) RTP (RFP1889) RTCP (RFC1890) G711, G.729a/b codecs (G.729a recommended) G.168 echo cancellation Silence Suppression / Voice Activity Detection (VAD) Comfort Noise Generation (CNG) Phone book Volume adjustable during calls Dialing Tone, Ring Back Tone, Busy Tone, Ring Tone, Holding Tone and Howler Tone Dynamic Jitter Butter. DTMF Detection and Generation DTMF: In-band and Out-band traffic (RFC2833),(PCM), (SIP INFO) Point-to-point call establishment between two Prestiges Quick dialing through predefined phone book, which maps the phone dialing number and destination URL. Caller ID support.
Other Features	QoS Support SNTP server to update date and time SSL log in (option) MD5 support for SIP account Watchdog timer with automatic restart function

Appendix B

IP Subnetting

IP Addressing

Routers “route” based on the network number. The router that delivers the data packet to the correct destination host uses the host ID.

IP Classes

An IP address is made up of four octets (eight bits), written in dotted decimal notation, for example, 192.168.1.1. IP addresses are categorized into different classes. The class of an address depends on the value of its first octet.

- Class “A” addresses have a 0 in the left most bit. In a class “A” address the first octet is the network number and the remaining three octets make up the host ID.
- Class “B” addresses have a 1 in the left most bit and a 0 in the next left most bit. In a class “B” address the first two octets make up the network number and the two remaining octets make up the host ID.
- Class “C” addresses begin (starting from the left) with 1 1 0. In a class “C” address the first three octets make up the network number and the last octet is the host ID.
- Class “D” addresses begin with 1 1 1 0. Class “D” addresses are used for multicasting. (There is also a class “E” address. It is reserved for future use.)

Table 30 Classes of IP Addresses

IP ADDRESS:		OCTET 1	OCTET 2	OCTET 3	OCTET 4
Class A	0	Network number	Host ID	Host ID	Host ID
Class B	10	Network number	Network number	Host ID	Host ID
Class C	110	Network number	Network number	Network number	Host ID

Note: Host IDs of all zeros or all ones are not allowed.

Therefore:

A class “C” network (8 host bits) can have $2^8 - 2$ or 254 hosts.

A class “B” address (16 host bits) can have $2^{16} - 2$ or 65534 hosts.

A class “A” address (24 host bits) can have $2^{24} - 2$ hosts (approximately 16 million hosts).

Since the first octet of a class “A” IP address must contain a “0”, the first octet of a class “A” address can have a value of 0 to 127.

Similarly the first octet of a class “B” must begin with “10”, therefore the first octet of a class “B” address has a valid range of 128 to 191. The first octet of a class “C” address begins with “110”, and therefore has a range of 192 to 223.

Table 31 Allowed IP Address Range By Class

CLASS	ALLOWED RANGE OF FIRST OCTET (BINARY)	ALLOWED RANGE OF FIRST OCTET (DECIMAL)
Class A	00000000 to 01111111	0 to 127
Class B	10000000 to 10111111	128 to 191
Class C	11000000 to 11011111	192 to 223
Class D	11100000 to 11101111	224 to 239

Subnet Masks

A subnet mask is used to determine which bits are part of the network number, and which bits are part of the host ID (using a logical AND operation). A subnet mask has 32 is a “1” then the corresponding bit in the IP address is part of the network number. If a bit in the subnet mask is “0” then the corresponding bit in the IP address is part of the host ID.

Subnet masks are expressed in dotted decimal notation just as IP addresses are. The “natural” masks for class A, B and C IP addresses are as follows.

Table 32 “Natural” Masks

CLASS	NATURAL MASK
A	255.0.0.0
B	255.255.0.0
C	255.255.255.0

Subnetting

With subnetting, the class arrangement of an IP address is ignored. For example, a class C address no longer has to have 24 bits of network number and 8 bits of host ID. With subnetting, some of the host ID bits are converted into network number bits. By convention, subnet masks always consist of a continuous sequence of ones beginning from the left most bit of the mask, followed by a continuous sequence of zeros, for a total number of 32 bits.

Since the mask is always a continuous number of ones beginning from the left, followed by a continuous number of zeros for the remainder of the 32 bit mask, you can simply specify the number of ones instead of writing the value of each octet. This is usually specified by writing a “/” followed by the number of bits in the mask after the address.

For example, 192.1.1.0 /25 is equivalent to saying 192.1.1.0 with mask 255.255.255.128.

The following table shows all possible subnet masks for a class “C” address using both notations.

Table 33 Alternative Subnet Mask Notation

SUBNET MASK IP ADDRESS	SUBNET MASK “1” BITS	LAST OCTET BIT VALUE
255.255.255.0	/24	0000 0000
255.255.255.128	/25	1000 0000
255.255.255.192	/26	1100 0000
255.255.255.224	/27	1110 0000
255.255.255.240	/28	1111 0000
255.255.255.248	/29	1111 1000
255.255.255.252	/30	1111 1100

The first mask shown is the class “C” natural mask. Normally if no mask is specified it is understood that the natural mask is being used.

Example: Two Subnets

As an example, you have a class “C” address 192.168.1.0 with subnet mask of 255.255.255.0.

Table 34 Two Subnets Example

	NETWORK NUMBER	HOST ID
IP Address	192.168.1.	0
IP Address (Binary)	11000000.10101000.00000001.	00000000
Subnet Mask	255.255.255.	0
Subnet Mask (Binary)	11111111.11111111.11111111.	00000000

The first three octets of the address make up the network number (class “C”). You want to have two separate networks.

Divide the network 192.168.1.0 into two separate subnets by converting one of the host ID bits of the IP address to a network number bit. The “borrowed” host ID bit can be either “0” or “1” thus giving two subnets; 192.168.1.0 with mask 255.255.255.128 and 192.168.1.128 with mask 255.255.255.128.

Note: In the following charts, shaded/bolded last octet bit values indicate host ID bits “borrowed” to form network ID bits. The number of “borrowed” host ID bits determines the number of subnets you can have. The remaining number of host ID bits (after “borrowing”) determines the number of hosts you can have on each subnet.

Table 35 Subnet 1

	NETWORK NUMBER	LAST OCTET BIT VALUE
IP Address	192.168.1.	0
IP Address (Binary)	11000000.10101000.00000001.	00000000
Subnet Mask	255.255.255.	128
Subnet Mask (Binary)	11111111.11111111.11111111.	10000000
Subnet Address: 192.168.1.0	Lowest Host ID: 192.168.1.1	
Broadcast Address: 192.168.1.127	Highest Host ID: 192.168.1.126	

Table 36 Subnet 2

	NETWORK NUMBER	LAST OCTET BIT VALUE
IP Address	192.168.1.	128
IP Address (Binary)	11000000.10101000.00000001.	10000000
Subnet Mask	255.255.255.	128
Subnet Mask (Binary)	11111111.11111111.11111111.	10000000
Subnet Address: 192.168.1.128	Lowest Host ID: 192.168.1.129	
Broadcast Address: 192.168.1.255	Highest Host ID: 192.168.1.254	

The remaining 7 bits determine the number of hosts each subnet can have. Host IDs of all zeros represent the subnet itself and host IDs of all ones are the broadcast address for that subnet, so the actual number of hosts available on each subnet in the example above is $2^7 - 2$ or 126 hosts for each subnet.

192.168.1.0 with mask 255.255.255.128 is the subnet itself, and 192.168.1.127 with mask 255.255.255.128 is the directed broadcast address for the first subnet. Therefore, the lowest IP address that can be assigned to an actual host for the first subnet is 192.168.1.1 and the highest is 192.168.1.126. Similarly the host ID range for the second subnet is 192.168.1.129 to 192.168.1.254.

Example: Four Subnets

The above example illustrated using a 25-bit subnet mask to divide a class “C” address space into two subnets. Similarly to divide a class “C” address into four subnets, you need to “borrow” two host ID bits to give four possible combinations of 00, 01, 10 and 11. The subnet mask is 26 bits (11111111.11111111.11111111.11000000) or 255.255.255.192. Each subnet contains 6 host ID bits, giving 2^6-2 or 62 hosts for each subnet (all 0’s is the subnet itself, all 1’s is the broadcast address on the subnet).

Table 37 Subnet 1

	NETWORK NUMBER	LAST OCTET BIT VALUE
IP Address	192.168.1.	0
IP Address (Binary)	11000000.10101000.00000001.	00000000
Subnet Mask (Binary)	11111111.11111111.11111111.	11000000
Subnet Address: 192.168.1.0	Lowest Host ID: 192.168.1.1	
Broadcast Address: 192.168.1.63	Highest Host ID: 192.168.1.62	

Table 38 Subnet 2

	NETWORK NUMBER	LAST OCTET BIT VALUE
IP Address	192.168.1.	64
IP Address (Binary)	11000000.10101000.00000001.	01000000
Subnet Mask (Binary)	11111111.11111111.11111111.	11000000
Subnet Address: 192.168.1.64	Lowest Host ID: 192.168.1.65	
Broadcast Address: 192.168.1.127	Highest Host ID: 192.168.1.126	

Table 39 Subnet 3

	NETWORK NUMBER	LAST OCTET BIT VALUE
IP Address	192.168.1.	128
IP Address (Binary)	11000000.10101000.00000001.	10000000
Subnet Mask (Binary)	11111111.11111111.11111111.	11000000
Subnet Address: 192.168.1.128	Lowest Host ID: 192.168.1.129	
Broadcast Address: 192.168.1.191	Highest Host ID: 192.168.1.190	

Table 40 Subnet 4

	NETWORK NUMBER	LAST OCTET BIT VALUE
IP Address	192.168.1.	192
IP Address (Binary)	11000000.10101000.00000001.	11000000
Subnet Mask (Binary)	11111111.11111111.11111111.	11000000
Subnet Address: 192.168.1.192	Lowest Host ID: 192.168.1.193	
Broadcast Address: 192.168.1.255	Highest Host ID: 192.168.1.254	

Example Eight Subnets

Similarly use a 27-bit mask to create 8 subnets (001, 010, 011, 100, 101, 110).

The following table shows class C IP address last octet values for each subnet.

Table 41 Eight Subnets

SUBNET	SUBNET ADDRESS	FIRST ADDRESS	LAST ADDRESS	BROADCAST ADDRESS
1	0	1	30	31
2	32	33	62	63
3	64	65	94	95
4	96	97	126	127
5	128	129	158	159
6	160	161	190	191
7	192	193	222	223
8	224	225	254	255

The following table is a summary for class “C” subnet planning.

Table 42 Class C Subnet Planning

NO. “BORROWED” HOST BITS	SUBNET MASK	NO. SUBNETS	NO. HOSTS PER SUBNET
1	255.255.255.128 (/25)	2	126
2	255.255.255.192 (/26)	4	62
3	255.255.255.224 (/27)	8	30
4	255.255.255.240 (/28)	16	14
5	255.255.255.248 (/29)	32	6
6	255.255.255.252 (/30)	64	2
7	255.255.255.254 (/31)	128	1

Subnetting With Class A and Class B Networks.

For class “A” and class “B” addresses the subnet mask also determines which bits are part of the network number and which are part of the host ID.

A class “B” address has two host ID octets available for subnetting and a class “A” address has three host ID octets (see [Table 30 on page 111](#)) available for subnetting.

The following table is a summary for class “B” subnet planning.

Table 43 Class B Subnet Planning

NO. “BORROWED” HOST BITS	SUBNET MASK	NO. SUBNETS	NO. HOSTS PER SUBNET
1	255.255.128.0 (/17)	2	32766
2	255.255.192.0 (/18)	4	16382
3	255.255.224.0 (/19)	8	8190
4	255.255.240.0 (/20)	16	4094
5	255.255.248.0 (/21)	32	2046
6	255.255.252.0 (/22)	64	1022
7	255.255.254.0 (/23)	128	510
8	255.255.255.0 (/24)	256	254
9	255.255.255.128 (/25)	512	126
10	255.255.255.192 (/26)	1024	62
11	255.255.255.224 (/27)	2048	30
12	255.255.255.240 (/28)	4096	14
13	255.255.255.248 (/29)	8192	6
14	255.255.255.252 (/30)	16384	2
15	255.255.255.254 (/31)	32768	1

Appendix C

PPPoE

PPPoE in Action

An ADSL modem bridges a PPP session over Ethernet (PPP over Ethernet, RFC 2516) from your computer to an ATM PVC (Permanent Virtual Circuit) which connects to a DSL Access Concentrator where the PPP session terminates (see [Figure 38 on page 120](#)). One PVC can support any number of PPP sessions from your LAN. PPPoE provides access control and billing functionality in a manner similar to dial-up services using PPP.

Benefits of PPPoE

PPPoE offers the following benefits:

It provides you with a familiar dial-up networking (DUN) user interface.

It lessens the burden on the carriers of provisioning virtual circuits all the way to the ISP on multiple switches for thousands of users. For GSTN (PSTN and ISDN), the switching fabric is already in place.

It allows the ISP to use the existing dial-up model to authenticate and (optionally) to provide differentiated services.

Traditional Dial-up Scenario

The following diagram depicts a typical hardware configuration where the computers use traditional dial-up networking.

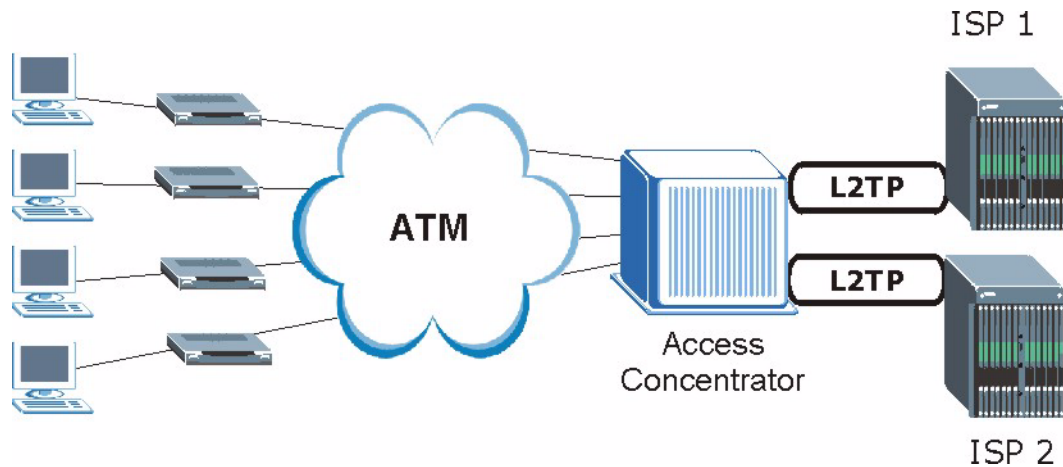
Figure 38 Single-Computer per Router Hardware Configuration

How PPPoE Works

The PPPoE driver makes the Ethernet appear as a serial link to the computer and the computer runs PPP over it, while the modem bridges the Ethernet frames to the Access Concentrator (AC). Between the AC and an ISP, the AC is acting as a L2TP (Layer 2 Tunneling Protocol) LAC (L2TP Access Concentrator) and tunnels the PPP frames to the ISP. The L2TP tunnel is capable of carrying multiple PPP sessions.

With PPPoE, the VC (Virtual Circuit) is equivalent to the dial-up connection and is between the modem and the AC, as opposed to all the way to the ISP. However, the PPP negotiation is between the computer and the ISP.

Prestige as a PPPoE Client

When using the Prestige as a PPPoE client, the computers on the LAN see only Ethernet and are not aware of PPPoE. This alleviates the administrator from having to manage the PPPoE clients on the individual computers.

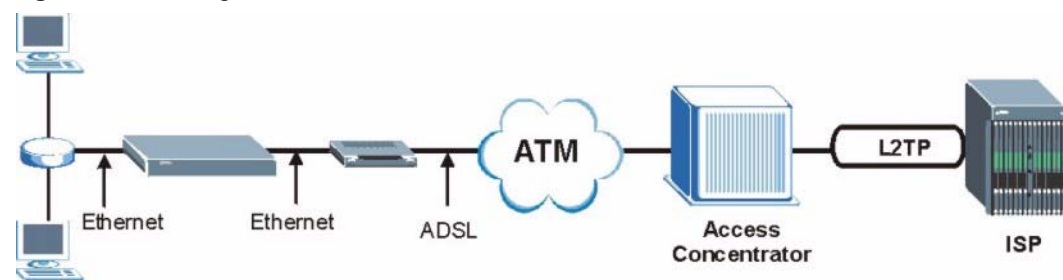
Figure 39 Prestige as a PPPoE Client

Appendix D

Wireless LANs

Wireless LAN Topologies

This section discusses ad-hoc and infrastructure wireless LAN topologies.

Ad-hoc Wireless LAN Configuration

The simplest WLAN configuration is an independent (Ad-hoc) WLAN that connects a set of computers with wireless stations (A, B, C). Any time two or more wireless adapters are within range of each other, they can set up an independent network, which is commonly referred to as an Ad-hoc network or Independent Basic Service Set (IBSS). The following diagram shows an example of notebook computers using wireless adapters to form an Ad-hoc wireless LAN.

Figure 40 Peer-to-Peer Communication in an Ad-hoc Network

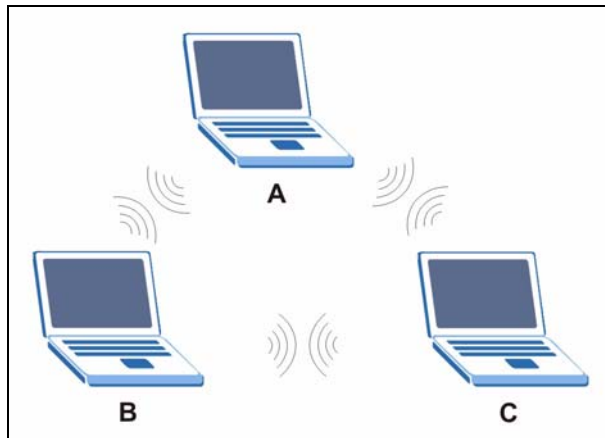

BSS

A Basic Service Set (BSS) exists when all communications between wireless stations or between a wireless station and a wired network client go through one access point (AP).

Intra-BSS traffic is traffic between wireless stations in the BSS. When Intra-BSS is enabled, wireless station A and B can access the wired network and communicate with each other. When Intra-BSS is disabled, wireless station A and B can still access the wired network but cannot communicate with each other.

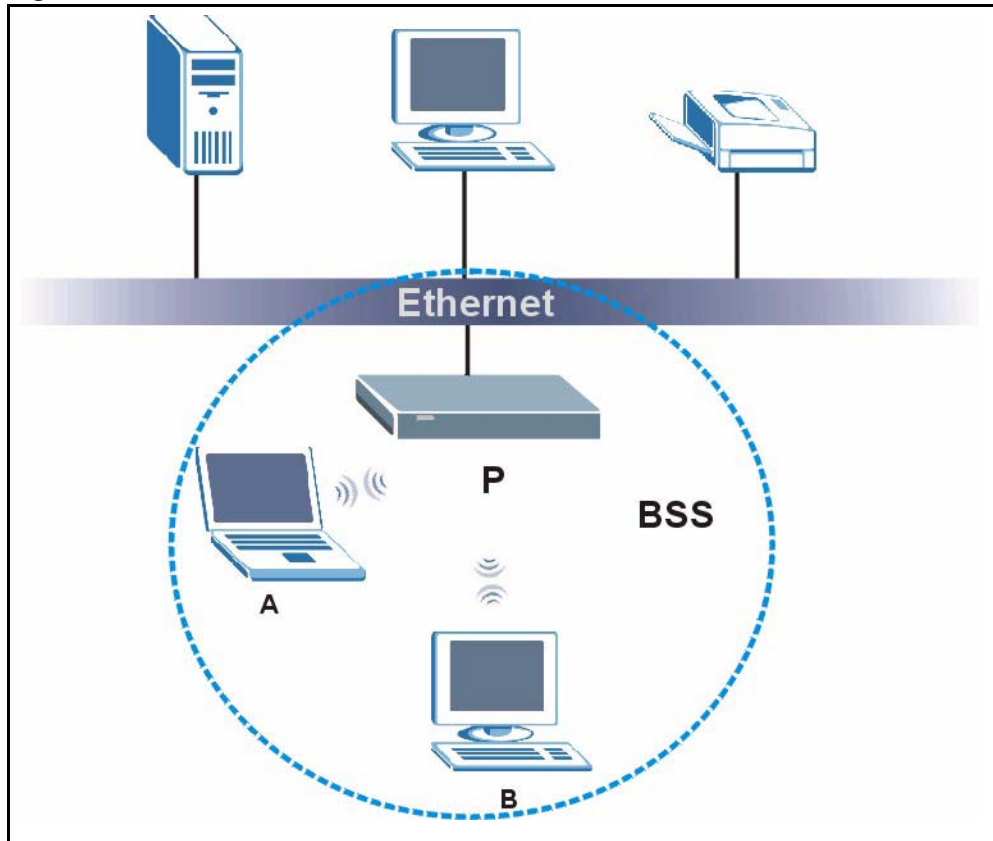
Figure 41 Basic Service Set

ESS

An Extended Service Set (ESS) consists of a series of overlapping BSSs, each containing an access point, with each access point connected together by a wired network. This wired connection between APs is called a Distribution System (DS).

This type of wireless LAN topology is called an Infrastructure WLAN. The Access Points not only provide communication with the wired network but also mediate wireless network traffic in the immediate neighborhood.

An ESSID (ESS IDentification) uniquely identifies each ESS. All access points and their associated wireless stations within the same ESS must have the same ESSID in order to communicate.

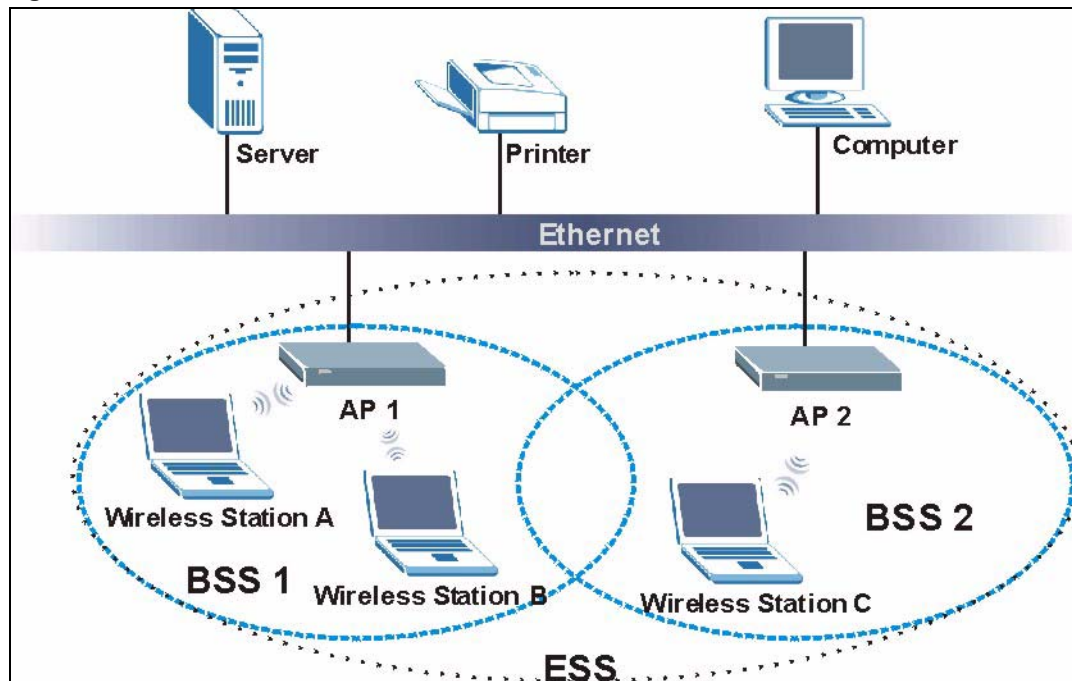
Figure 42 Infrastructure WLAN

Channel

A channel is the radio frequency(ies) used by IEEE 802.11a/b/g wireless devices. Channels available depend on your geographical area. You may have a choice of channels (for your region) so you should use a different channel than an adjacent AP (access point) to reduce interference. Interference occurs when radio signals from different access points overlap causing interference and degrading performance.

Adjacent channels partially overlap however. To avoid interference due to overlap, your AP should be on a channel at least five channels away from a channel that an adjacent AP is using. For example, if your region has 11 channels and an adjacent AP is using channel 1, then you need to select a channel between 6 or 11.

Roaming

A wireless station is a device with an IEEE 802.11 mode compliant wireless adapter. An access point (AP) acts as a bridge between the wireless and wired networks. An AP creates its own wireless coverage area. A wireless station can associate with a particular access point only if it is within the access point's coverage area.

In a network environment with multiple access points, wireless stations are able to switch from one access point to another as they move between the coverage areas. This is roaming. As the wireless station moves from place to place, it is responsible for choosing the most appropriate access point depending on the signal strength, network utilization or other factors.

The roaming feature on the access points allows the access points to relay information about the wireless stations to each other. When a wireless station moves from a coverage area to another, it scans and uses the channel of a new access point, which then informs the access points on the LAN about the change. The new information is then propagated to the other access points on the LAN. An example is shown in [see Figure 43](#).

If the roaming feature is not enabled on the access points, information is not communicated between the access points when a wireless station moves between coverage areas. The wireless station may not be able to communicate with other wireless stations on the network and vice versa.

Figure 43 Roaming Example

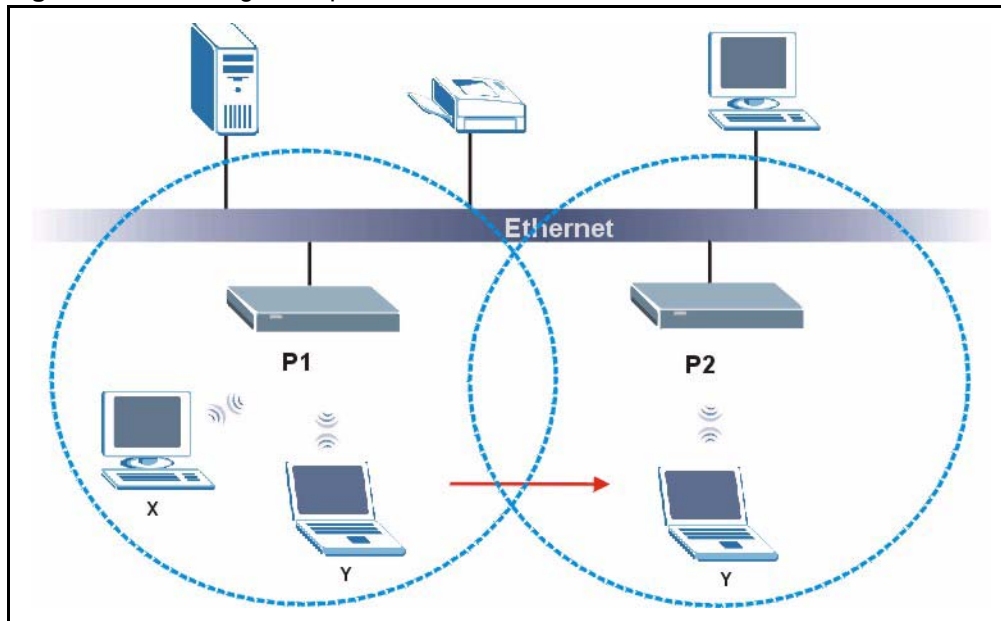

The steps below describe the roaming process.

- 1 As wireless station **Y** moves from the coverage area of access point **P1** to that of access point
- 2 **P2**, it scans and uses the signal of access point **P2**.
- 3 Access point **P2** acknowledges the presence of wireless station **Y** and relays this information to access point **P1** through the wired LAN.
- 4 Access point **P1** updates the new position of wireless station.
- 5 Wireless station **Y** sends a request to access point **P2** for re-authentication.

Requirements for Roaming

The following requirements must be met in order for wireless stations to roam between the coverage areas.

- 1 All the access points must be on the same subnet and configured with the same ESSID.

- 2** If IEEE 802.1x user authentication is enabled and to be done locally on the access point, the new access point must have the user profile for the wireless station.
- 3** The adjacent access points should use different radio channels when their coverage areas overlap.
- 4** All access points must use the same port number to relay roaming information.
- 5** The access points must be connected to the Ethernet and be able to get IP addresses from a DHCP server if using dynamic IP address assignment.

Index

Numerics

110V AC [6](#)
230V AC [6](#)
64kbps [102](#)
8kbps [102](#)

A

Abnormal Working Conditions [7](#)
AbS [101](#)
AC [6](#)
Accessories [6](#)
ACK Message [80](#)
Acts of God [7](#)
Address Assignment [75](#)
Administrator Screens Summary [71](#)
Airflow [6](#)
ALG [88](#)
Alternative Subnet Mask Notation [113](#)
Analysis-by-Synthesis [101](#)
AP (access point) [123](#)
Application Layer Gateway [88](#)
Authority [4](#)

B

Basement [6](#)
BSS [121](#)
Buffer, Jitter [23](#)
BYE Request [80](#)

C

Cables, Connecting [6](#)
Certifications [4](#)
Changes or Modifications [4](#)
Channel [123](#)
 Interference [123](#)

Charge [7](#)
Circuit [4](#)
Circuit-switched Telephone Networks [79](#)
Class B [4](#)
Clicks [101](#)
Client Server, SIP [80](#)
Client-server Protocol [80](#)
Codec [100](#), [102](#)
Codecs [24](#)
Coder/Decoder [100](#), [102](#)
Comfort Noise Generation [24](#)
Communications [4](#)
Compliance, FCC [4](#)
Components [7](#)
Computer [22](#)
Condition [7](#)
Connecting Cables [6](#)
Consequential Damages [7](#)
Contact Information [8](#)
Contacting Customer Support [8](#)
Copyright [3](#)
Correcting Interference [4](#)
Corrosive Liquids [6](#)
Covers [6](#)
Customer Support [8](#)

D

Damage [6](#)
Dampness [6](#)
Danger [6](#)
Dealer [4](#)
Decoder [100](#)
Defective [7](#)
Denmark, Contact Information [8](#)
Dial-up Networking User Interface, See PPPoE [24](#)
Differentiated Services [23](#)
DiffServ [23](#)
Disclaimer [3](#)
Discretion [7](#)
Domain Name [75](#)
DTMF [101](#)

Dual-Tone MultiFrequency [101](#)
Dust [6](#)
Dynamic Jitter Buffer [23](#)

E

Electric Shock [6](#)
Electrocution [6](#)
Enter See Syntax Conventions
Equal Value [7](#)
ESS [122](#)
Ethernet [43, 78](#)
Europe [6](#)
Expiration Duration [100](#)
Exposure [6](#)
Extended Service Set [122](#)
Extended Service Set IDentification [34, 94](#)
External IP Addresses [83](#)

F

Failure [7](#)
Fake WAN Address on SIP and RTP [88, 91](#)
FCC [4](#)
 Compliance [4](#)
 Rules, Part 15 [4](#)
FCC Rules [4](#)
Federal Communications Commission [4](#)
Finland, Contact Information [8](#)
Firmware Upgrades [24](#)
Fitness [7](#)
France, Contact Information [8](#)
Frequency Pairs [101](#)
Full Cone NAT [85](#)
Functionally Equivalent [7](#)

G

G.711 [24, 100, 102](#)
G.729 [24, 101, 102](#)
Germany, Contact Information [8](#)
God, Acts of [7](#)

H

Harmful Interference [4](#)
High Voltage Points [6](#)
Host IDs [111](#)
Hybrid, Waveform Codec [101](#)

I

IBSS [121](#)
Independent Basic Service Set [121](#)
Indirect Damages [7](#)
Insurance [7](#)
Interference [4](#)
Interference Correction Measures [4](#)
Interference Statement [4](#)
Internal IP Addresses [83](#)
Internet Telephony Service Provider [79](#)
IP Addressing [111](#)
IP Classes [111](#)
IP-PBX [79](#)
ITSP [24, 79](#)

J

Jitter Buffer [23](#)

L

Labor [7](#)
Legal Rights [7](#)
Liability [3](#)
License [3](#)
Lightning [6](#)
Liquids, Corrosive [6](#)
Listening Port [91](#)
Listening Port, Register Server's [100](#)
Listening Port, SIP Server's [99](#)

M

Materials [7](#)

Merchantability [7](#)
 Modem [22](#)
 Modifications [4](#)
 Multimedia [79](#)

N

NAT [83](#)
 Full Cone [85](#)
 Symmetric [87](#)
 NAT Routers [89](#)
 NAT Types [84](#)
 NAT, Incoming [84](#)
 NAT, Outgoing [84](#)
 Network Address Translation [83](#)
 Network Address Translators [89](#)
 Network Type
 Ad-Hoc(IBSS) [25](#)
 New [7](#)
 North America [6](#)
 North America Contact Information [8](#)
 Norway, Contact Information [8](#)
 Notebook Computer [22](#)

O

OK Response [80](#)
 Opening [6](#)
 Operating Condition [7](#)
 Outbound Proxy [24, 88, 89](#)
 Outbound Proxy Server [89](#)
 Outbound Proxy, SIP [89](#)
 Out-dated Warranty [7](#)
 Outlet [4](#)

P

P2P [52, 92](#)
 Parts [7](#)
 Patent [3](#)
 PBX Services [79](#)
 PCM [100, 101](#)
 Permission [3](#)
 Photocopying [3](#)
 Point-to-Point Protocol over Ethernet [24](#)

Pool [6](#)
 Port [83](#)
 Port Restricted Cone NAT [87](#)
 Postage Prepaid. [7](#)
 Power Adaptor [6](#)
 Power Cord [6](#)
 Power Outlet [6](#)
 Power Supply [6](#)
 Power Supply, repair [6](#)
 PPPoE [43, 78, 119](#)
 Prestige [22](#)
 Private IP Addresses [83](#)
 Problems [105](#)
 Product Model [8](#)
 Product Page [4](#)
 Product Serial Number [8](#)
 Products [7](#)
 Proof of Purchase [7](#)
 Proper Operating Condition [7](#)
 Proxy [52, 92](#)
 Proxy Server, SIP [81](#)
 PSTN [101](#)
 Public IP Addresses [83](#)
 Public Switched Telephone Network [101](#)
 Pulse Code Modulation [100](#)
 Pulse Dialing [101](#)
 Purchase, Proof of [7](#)
 Purchaser [7](#)

Q

QoS [23](#)
 Qualified Service Personnel [6](#)
 Quality of Service [23](#)
 Quality of Service (QoS) [23](#)

R

Radio Communications [4](#)
 Radio Frequency Energy [4](#)
 Radio Interference [4](#)
 Radio Reception [4](#)
 Radio Technician [4](#)
 Read Me First [21](#)
 Real time Transport Protocol [82, 102](#)
 Receiving Antenna [4](#)

Redirect Server, SIP [81](#)
REGISTER Server Address [100](#)
REGISTER Server Port [100](#)
Register Server, SIP [82](#)
Registered [3](#)
Registered Trademark [3](#)
Regular Mail [8](#)
Related Documentation [21](#)
Relocate [4](#)
Re-manufactured [7](#)
Removing [6](#)
Reorient [4](#)
Repair [6, 7](#)
Replace [7](#)
Replacement [7](#)
Reproduction [3](#)
Required Bandwidth [101](#)
Restore [7](#)
Restricted Cone NAT [86](#)
Return Material Authorization (RMA) Number [7](#)
Returned Products [7](#)
Returns [7](#)
RFC 1889 [82](#)
RFC 2833 [102](#)
RFC 3489 [89](#)
Rights [3](#)
Rights, Legal [7](#)
Risk [6](#)
Risks [6](#)
RMA [7](#)
Roaming [123](#)
 Example [124](#)
 Requirements [124](#)
Router [22](#)
RTP [82](#)

S

Safety Warnings [6](#)
Select See Syntax Conventions
Separation Between Equipment and Receiver [4](#)
Serial Number [8](#)
Server [22](#)
Server, Outbound Proxy [89](#)
Service [6, 7](#)
Service Personnel [6](#)
Service Set [34, 94](#)
Session Expires [100](#)

Session Initiation Protocol [79](#)
Shipping [7](#)
Shock, Electric [6](#)
Silence Suppression [24](#)
SIP Account [79](#)
SIP ACK Message [80](#)
SIP ALG [88](#)
SIP Application Layer Gateway [88](#)
SIP BYE Request [80](#)
SIP Call Progression [80](#)
SIP Client [80](#)
SIP Client Server [80](#)
SIP Identities [79](#)
SIP INVITE Request [80](#)
SIP Number [79](#)
SIP OK Response [80](#)
SIP Outbound Proxy [89](#)
SIP Proxy Server [81](#)
SIP Redirect Server [81](#)
SIP Register Server [82](#)
SIP Server Address [99](#)
SIP Server Port [99](#)
SIP Servers [80](#)
SIP Service Domain [80, 100](#)
SIP URI [79, 92](#)
SIP User Agent [80](#)
Sound Quality [100](#)
Spain, Contact Information [8](#)
Start Up Problems [105](#)
STUN [23, 88, 89](#)
Subnet Masks [112](#)
Subnetting [112](#)
Supply Voltage [6](#)
Support E-mail [8](#)
Supporting Disk [21](#)
Sweden, Contact Information [8](#)
Swimming Pool [6](#)
Switch [22](#)
Symmetric NAT [87](#)
Symmetric NAT, Outgoing [88](#)
Syntax Conventions [21](#)

T

Tampering [7](#)
Telephone [8, 22](#)
Telephone Keys [101](#)
Television Interference [4](#)

Television Reception [4](#)
Thunderstorm [6](#)
ToS [23](#)
Touch Tone® [101](#)
Trademark [3](#)
Trademark Owners [3](#)
Trademarks [3](#)
Translation [3](#)
Troubleshooting
 Radio interference [106](#)
TV Technician [4](#)
Type of Service [23](#)

U

Undesired Operations [4](#)
Uniform Resource Identifier [79](#)
User Agent, SIP [80](#)
User Screens Summary [71](#)

V

VAD [24](#)
Value [7](#)
Vendor [6](#)
Ventilation Slots [6](#)
Viewing Certifications [4](#)
Voice Activity Detection [24](#)
Voice Coding [24](#), [100](#)
Voice Mail [79](#)
Voice over IP [79](#)
VoIP [79](#)
Voltage Supply [6](#)
Voltage, High [6](#)

W

WAN Setup [74](#)
Warnings [6](#)
Warranty [7](#)
Warranty Information [8](#)
Warranty Period [7](#)
Water [6](#)
Waveform Codec [100](#)

Web Configurator [70](#)
Web Configurator Administrator Screens Summa [71](#)
Web Configurator User Screens Summary [71](#)
Web Site [8](#)
WEP [36](#)
WEP Encryption [93](#)
WEP Key [36](#)
Wet Basement [6](#)
Wired Equivalent Privacy See WEP
WLAN
 Interference [123](#)
Workmanship [7](#)
Worldwide Contact Information [8](#)
Written Permission [3](#)

Z

ZyNOS [3](#)
ZyXEL Communications Corporation [3](#)
ZyXEL Home Page [4](#)
ZyXEL Limited Warranty
 Note [7](#)
ZyXEL Network Operating System [3](#)