

Prestige 653HWI Series

ADSL Security Gateway with IEEE802.11g and ISDN Backup

User's Guide

Version 3.40

December 2003



Copyright

Copyright © 2003 by ZyXEL Communications Corporation.

The contents of this publication may not be reproduced in any part or as a whole, transcribed, stored in a retrieval system, translated into any language, or transmitted in any form or by any means, electronic, mechanical, magnetic, optical, chemical, photocopying, manual, or otherwise, without the prior written permission of ZyXEL Communications Corporation.

Published by ZyXEL Communications Corporation. All rights reserved.

Disclaimer

ZyXEL does not assume any liability arising out of the application or use of any products, or software described herein. Neither does it convey any license under its patent rights nor the patent rights of others. ZyXEL further reserves the right to make changes in any products described herein without notice. This publication is subject to change without notice.

Trademarks

ZyNOS (ZyXEL Network Operating System) is a registered trademark of ZyXEL Communications, Inc. Other trademarks mentioned in this publication are used for identification purposes only and may be properties of their respective owners.

Federal Communications Commission (FCC) Interference Statement

This device complies with Part 15 of FCC rules. Operation is subject to the following two conditions:

- This device may not cause harmful interference.
- This device must accept any interference received, including interference that may cause undesired operations.

This equipment has been tested and found to comply with the limits for a Class B digital device pursuant to Part 15 of the FCC Rules. These limits are designed to provide reasonable protection against harmful interference in a commercial environment. This equipment generates, uses, and can radiate radio frequency energy, and if not installed and used in accordance with the instructions, may cause harmful interference to radio communications.

If this equipment does cause harmful interference to radio/television reception, which can be determined by turning the equipment off and on, the user is encouraged to try to correct the interference by one or more of the following measures:

1. Reorient or relocate the receiving antenna.
2. Increase the separation between the equipment and the receiver.
3. Connect the equipment into an outlet on a circuit different from that to which the receiver is connected.
4. Consult the dealer or an experienced radio/TV technician for help.

Notice 1

Changes or modifications not expressly approved by the party responsible for compliance could void the user's authority to operate the equipment.

Certifications

Refer to the product page at www.zyxel.com.

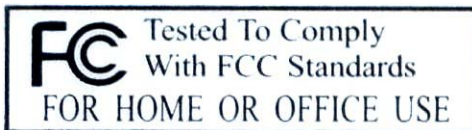

ZyXEL Limited Warranty

ZyXEL warrants to the original end user (purchaser) that this product is free from any defects in materials or workmanship for a period of up to two years from the date of purchase. During the warranty period, and upon proof of purchase, should the product have indications of failure due to faulty workmanship and/or materials, ZyXEL will, at its discretion, repair or replace the defective products or components without charge for either parts or labor, and to whatever extent it shall deem necessary to restore the product or components to proper operating condition. Any replacement will consist of a new or re-manufactured functionally equivalent product of equal value, and will be solely at the discretion of ZyXEL. This warranty shall not apply if the product is modified, misused, tampered with, damaged by an act of God, or subjected to abnormal working conditions.

Note

Repair or replacement, as provided under this warranty, is the exclusive remedy of the purchaser. This warranty is in lieu of all other warranties, express or implied, including any implied warranty of merchantability or fitness for a particular use or purpose. ZyXEL shall in no event be held liable for indirect or consequential damages of any kind of character to the purchaser.

To obtain the services of this warranty, contact ZyXEL's Service Center for your Return Material Authorization number (RMA). Products must be returned Postage Prepaid. It is recommended that the unit be insured when shipped. Any returned products without proof of purchase or those with an out-dated warranty will be repaired or replaced (at the discretion of ZyXEL) and the customer will be billed for parts and labor. All repaired or replaced products will be shipped by ZyXEL to the corresponding return address, Postage Paid. This warranty gives you specific legal rights, and you may also have other rights that vary from country to country.

Safety Warnings

1. To reduce the risk of fire, use only No. 26 AWG or larger telephone wire.
2. Do not use this product near water, for example, in a wet basement or near a swimming pool.
3. Avoid using this product during an electrical storm. There may be a remote risk of electric shock from lightning.

Customer Support

Please have the following information ready when you contact customer support.

- Product model and serial number.
- Warranty Information.
- Date that you received your device.
- Brief description of the problem and the steps you took to solve it.

METHOD LOCATION	E-MAIL SUPPORT/SALES	TELEPHONE/FAX	WEB SITE/ FTP SITE	REGULAR MAIL
WORLDWIDE	support@zyxel.com.tw sales@zyxel.com.tw	+886-3-578-3942 +886-3-578-2439	www.zyxel.com www.europe.zyxel.com ftp.zyxel.com ftp.europe.zyxel.com	ZyXEL Communications Corp., 6 Innovation Road II, Science- Based Industrial Park, Hsinchu 300, Taiwan
NORTH AMERICA	support@zyxel.com sales@zyxel.com	+1-800-255-4101	www.us.zyxel.com ftp.us.zyxel.com	ZyXEL Communications Inc., 1130 N. Miller St. Anaheim, CA 92806, U.S.A.
SCANDINAVIA	support@zyxel.dk sales@zyxel.dk	+45-3955-0700 +45-3955-0707	www.zyxel.dk ftp.zyxel.dk	ZyXEL Communications A/S, Columbusvej 5, 2860 Soeborg, Denmark
GERMANY	support@zyxel.de sales@zyxel.de	+49-2405-6909-0 +49-2405-6909-99	www.zyxel.de	ZyXEL Deutschland GmbH. Adenauerstr. 20/A2 D-52146 Wuerselen, Germany

Table of Contents

Copyright	ii
Federal Communications Commission (FCC) Interference Statement	iii
ZyXEL Limited Warranty	iv
Customer Support	v
List of Figures	xiv
List of Tables	xxi
List of Charts	xxv
Preface	xxvi
Introduction to DSL	xxviii
Getting Started	I
Chapter 1 Getting To Know Your Prestige	1-1
1.1 Introducing the Prestige 653HWI	1-1
1.2 Features of the Prestige	1-2
1.3 Applications for the Prestige	1-8
Chapter 2 Introducing the Web Configurator	2-1
2.1 Web Configurator Overview	2-1
2.2 Accessing the Prestige Web Configurator	2-1
2.3 Navigating the Prestige Web Configurator	2-2
2.4 Resetting the Prestige	2-3
Chapter 3 Wizard Setup	3-1
3.1 Wizard Setup Introduction	3-1
3.2 Encapsulation	3-1
3.3 Multiplexing	3-2
3.4 VPI and VCI	3-2
3.5 Wizard Setup Configuration: First Screen	3-2
3.6 IP Address and Subnet Mask	3-4
3.7 IP Address Assignment	3-4
3.8 Nailed-Up Connection (PPP)	3-6
3.9 NAT	3-6
3.10 Wizard Setup Configuration: Second Screen	3-6
3.11 DHCP Setup	3-11
3.12 Wizard Setup Configuration: Third Screen	3-12
3.13 Wizard Setup Configuration: Connection Tests	3-14
3.14 Test Your Internet Connection	3-15
Password, LAN, Wireless LAN and WAN	II
Chapter 4 Password Setup	4-1
4.1 Password Overview	4-1
4.2 Configuring Password	4-1

Chapter 5 LAN Setup	5-1
5.1 LAN Overview	5-1
5.2 DNS Server Address	5-1
5.3 DNS Server Address Assignment	5-2
5.4 LAN TCP/IP	5-2
5.5 Configuring LAN	5-4
Chapter 6 Wireless LAN Setup	6-1
6.1 Wireless LAN Overview	6-1
6.2 Levels of Security	6-3
6.3 Data Encryption with WEP	6-4
6.4 Configuring MAC Filter	6-6
6.5 Network Authentication	6-8
6.6 Configuring 802.1x	6-10
6.7 Configuring Local User Authentication	6-12
6.8 Configuring RADIUS	6-14
Chapter 7 WAN Setup	7-1
7.1 WAN Overview	7-1
7.2 ISDN	7-1
7.3 NetCAPI	7-1
7.4 Metric	7-2
7.5 PPPoE Encapsulation	7-2
7.6 Traffic Shaping	7-3
7.7 Configuring WAN Functions	7-4
7.8 Configuring WAN DSL Setup	7-6
7.9 ISDN Connection Setup	7-10
7.10 ISDN Dial In Setup	7-13
7.11 Configuring NetCAPI	7-15
7.12 WAN Backup	7-18
7.13 Traffic Redirect on the LAN	7-18
7.14 Traffic Redirect on the WAN	7-18
7.15 Configuring WAN Backup	7-21
NAT, Dynamic DNS and Time Zone	III
Chapter 8 Network Address Translation (NAT) Screens	8-1
8.1 NAT Overview	8-1
8.2 SUA (Single User Account) Versus NAT	8-5
8.3 SUA Server	8-6
8.4 Selecting the NAT Mode	8-8
8.5 Configuring SUA Server	8-9
8.6 Configuring Address Mapping	8-11
8.7 Editing an Address Mapping Rule	8-12
Chapter 9 Dynamic DNS Setup	9-1

9.1	Dynamic DNS.....	9-1
9.2	Configuring Dynamic DNS	9-1
Chapter 10	Time Zone.....	10-1
10.1	Configuring Time Zone	10-1
Firewall and Content Filters		IV
Chapter 11	Firewalls.....	11-1
11.1	Firewall Overview	11-1
11.2	Types of Firewalls.....	11-1
11.3	Introduction to ZyXEL's Firewall	11-2
11.4	Denial of Service	11-3
11.5	Stateful Inspection	11-7
11.6	Guidelines For Enhancing Security With Your Firewall	11-11
11.7	Packet Filtering Vs Firewall	11-12
Chapter 12	Firewall Configuration	12-1
12.1	Remote Management and the Firewall	12-1
12.2	Enabling the Firewall.....	12-1
12.3	Attack Alert.....	12-2
Chapter 13	Creating Custom Rules	13-1
13.1	Rules Overview.....	13-1
13.2	Rule Logic Overview.....	13-1
13.3	Connection Direction.....	13-3
13.4	Logs	13-5
13.5	Rule Summary	13-5
13.6	Predefined Services.....	13-7
13.7	Creating/Editing Firewall Rules.....	13-10
13.8	Timeout.....	13-13
Chapter 14	Customized Services	14-1
14.1	Introduction to Customized Services	14-1
14.2	Creating/Editing A Customized Service	14-2
14.3	Example Custom Service Firewall Rule	14-3
Chapter 15	Content Filtering Screens.....	15-1
15.1	Content Filtering Overview	15-1
15.2	Configuring Keyword Blocking.....	15-1
15.3	Configuring the Schedule	15-3
15.4	Configuring Trusted Computers	15-4
VPN/IPSec.....		V
Chapter 16	Introduction to IPSec.....	16-1
16.1	VPN Overview.....	16-1
16.2	IPSec Architecture	16-3
16.3	Encapsulation.....	16-4
16.4	IPSec and NAT	16-4

Chapter 17 VPN Screens	17-1
17.1 VPN/IPSec Overview.....	17-1
17.2 IPSec Algorithms	17-1
17.3 My IP Address.....	17-2
17.4 Secure Gateway Address.....	17-2
17.5 VPN Summary Screen	17-3
17.6 Keep Alive	17-5
17.7 ID Type and Content.....	17-5
17.8 Pre-Shared Key	17-7
17.9 Editing VPN Policies	17-7
17.10 IKE Phases.....	17-13
17.11 Configuring Advanced IKE Settings.....	17-14
17.12 Manual Key Setup.....	17-18
17.13 Configuring Manual Key	17-19
17.14 Viewing SA Monitor.....	17-22
17.15 Configuring Global Setting.....	17-24
17.16 Telecommuter VPN/IPSec Examples	17-25
17.17 VPN and Remote Management.....	17-27
Remote Management, UPnP and Logs.....	VI
Chapter 18 Remote Management Configuration	18-1
18.1 Remote Management Overview.....	18-1
18.2 Telnet	18-2
18.3 FTP.....	18-3
18.4 Web.....	18-3
18.5 Configuring Remote Management	18-3
Chapter 19 Universal Plug-and-Play (UPnP)	19-1
19.1 Introducing Universal Plug and Play.....	19-1
19.2 UPnP and ZyXEL	19-2
19.3 Installing UPnP in Windows Example.....	19-3
19.4 Using UPnP in Windows XP Example	19-5
Chapter 20 Logs Screens	20-1
20.1 Logs Overview.....	20-1
20.2 Configuring Log Settings.....	20-1
20.3 Displaying the Logs	20-4
20.4 SMTP Error Messages	20-5
Bandwidth Management	VII
Chapter 21 Bandwidth Management	21-1
21.1 Bandwidth Management Overview.....	21-1
21.2 Bandwidth Classes and Filters	21-1
21.3 Proportional Bandwidth Allocation.....	21-2
21.4 Bandwidth Management Usage Examples.....	21-2

21.5	Scheduler	21-4
21.6	Maximize Bandwidth Usage	21-4
21.7	Bandwidth Borrowing	21-7
21.8	Configuring Summary	21-9
21.9	Configuring Class Setup	21-11
21.10	Configuring Monitor	21-18
Maintenance		VIII
Chapter 22 Maintenance		22-1
22.1	Maintenance Overview	22-1
22.2	System Status Screen	22-1
22.3	DHCP Table Screen	22-6
22.4	Wireless Screens	22-7
22.5	Diagnostic Screens	22-9
22.6	Firmware Screen	22-14
SMT General Configuration		IX
Chapter 23 Introducing the SMT		23-1
23.1	SMT Introduction	23-1
23.2	Navigating the SMT Interface	23-3
23.3	Changing the System Password	23-6
Chapter 24 Menu 1 General Setup		24-1
24.1	General Setup	24-1
24.2	Procedure To Configure Menu 1	24-1
Chapter 25 Menu 2 WAN Backup Setup		25-1
25.1	Introduction to WAN Backup Setup	25-1
25.2	ISDN Dial Backup	25-1
25.3	Configuring Dial Backup in Menu 2	25-1
25.4	Configuring ISDN Dial Backup Setup	25-4
25.5	ISDN Advanced Setup Menus	25-5
25.6	NetCAPI Setup Menu	25-8
25.7	ISDN Remote Node Profile	25-10
25.8	Editing PPP Options	25-12
25.9	Editing TCP/IP Options	25-14
25.10	Editing Login Script	25-16
25.11	Remote Node Filter	25-18
Chapter 26 Menu 3 LAN Setup		26-1
26.1	LAN Setup	26-1
26.2	Protocol Dependent Ethernet Setup	26-2
26.3	TCP/IP Ethernet Setup and DHCP	26-2
Chapter 27 Wireless LAN Setup		27-1
27.1	Wireless LAN Overview	27-1
27.2	Wireless LAN Setup	27-1

Chapter 28 Internet Access	28-1
28.1 Internet Access Overview	28-1
28.2 IP Policies	28-1
28.3 IP Alias.....	28-1
28.4 IP Alias Setup.....	28-2
28.5 Route IP Setup.....	28-4
28.6 Internet Access Configuration.....	28-5
Chapter 29 Remote Node Configuration.....	29-1
29.1 Remote Node Setup Overview.....	29-1
29.2 Remote Node Setup.....	29-1
29.3 Remote Node Network Layer Options.....	29-5
29.4 Remote Node Filter.....	29-8
29.5 Editing ATM Layer Options.....	29-9
Chapter 30 Static Route Setup.....	30-1
30.1 IP Static Route Overview.....	30-1
30.2 Configuration.....	30-2
Chapter 31 Bridging Setup.....	31-1
31.1 Bridging in General.....	31-1
31.2 Bridge Ethernet Setup.....	31-1
Chapter 32 Network Address Translation (NAT).....	32-1
32.1 Using NAT.....	32-1
32.2 Applying NAT.....	32-1
32.3 NAT Setup.....	32-3
32.4 Configuring a Server behind NAT.....	32-9
32.5 General NAT Examples.....	32-11
Chapter 33 Enabling the Firewall.....	33-1
33.1 Remote Management and the Firewall.....	33-1
33.2 Access Methods.....	33-1
33.3 Enabling the Firewall.....	33-1
SMT Advanced Management.....	X
Chapter 34 Filter Configuration.....	34-1
34.1 About Filtering.....	34-1
34.2 Configuring a Filter Set for the Prestige.....	34-4
34.3 Configuring a Filter Set for the Prestige.....	34-6
34.4 Filter Rules Summary Menus.....	34-7
34.5 Configuring a Filter Rule.....	34-8
34.6 Filter Types and NAT.....	34-15
34.7 Example Filter.....	34-15
34.8 Applying Filters and Factory Defaults.....	34-18
Chapter 35 SNMP Configuration.....	35-1
35.1 About SNMP.....	35-1

35.2	Supported MIBs	35-2
35.3	SNMP Configuration	35-2
35.4	SNMP Traps	35-4
Chapter 36	System Security	36-1
36.1	System Security	36-1
36.2	Creating User Accounts on the Prestige.....	36-5
Chapter 37	System Information and Diagnosis.....	37-1
37.1	System Status.....	37-1
37.2	System Information.....	37-3
37.3	Log and Trace	37-5
37.4	Diagnostic	37-8
Chapter 38	Firmware and Configuration File Maintenance	38-1
38.1	Filename Conventions	38-1
38.2	Backup Configuration	38-2
38.3	Restore Configuration	38-7
38.4	Uploading Firmware and Configuration Files	38-10
Chapter 39	System Maintenance.....	39-1
39.1	Command Interpreter Mode.....	39-1
39.2	Call Control Support	39-2
39.3	Time and Date Setting	39-4
Chapter 40	Remote Management.....	40-1
40.1	Remote Management Overview.....	40-1
40.2	Remote Management	40-1
40.3	Remote Management and NAT	40-3
40.4	System Timeout	40-3
Chapter 41	IP Policy Routing	41-1
41.1	IP Policy Routing Overview	41-1
41.2	Benefits of IP Policy Routing	41-1
41.3	Routing Policy	41-1
41.4	IP Routing Policy Setup.....	41-2
41.5	Applying an IP Policy.....	41-5
41.6	IP Policy Routing Example.....	41-7
Chapter 42	Call Scheduling	42-1
42.1	Introduction.....	42-1
SMT VPN/IPSec and Internal SPTGEN.....		XI
Chapter 43	VPN/IPSec Setup.....	43-1
43.1	VPN/IPSec Overview	43-1
43.2	IPSec Summary Screen.....	43-2
43.3	IPSec Setup	43-6
43.4	IKE Setup.....	43-11
43.5	Manual Setup	43-13

Chapter 44 SA Monitor	44-1
44.1 SA Monitor Overview.....	44-1
44.2 Using SA Monitor.....	44-1
Chapter 45 Internal SPTGEN.....	45-1
45.1 Internal SPTGEN Overview.....	45-1
45.2 The Configuration Text File Format	45-1
45.3 Internal SPTGEN FTP Download Example.....	45-3
45.4 Internal SPTGEN FTP Upload Example.....	45-4
Appendices and Index.....	XII
Appendix A Troubleshooting.....	A-1
Appendix B IP Subnetting.....	B-1
Appendix C Wireless LAN and IEEE 802.11.....	C-1
Appendix D Antenna Selection and Positioning Recommendation	D-1
Appendix E PPPoE	E-1
Appendix F Virtual Circuit Topology	F-1
Appendix G Power Adaptor Specifications.....	G-1
Appendix H Example Internal SPTGEN Screens	H-1
Appendix I Setting up Your Computer's IP Address	I-1
Appendix J Splitters and Microfilters	J-1
Appendix K Log Descriptions	K-1
Appendix L Index.....	L-1

List of Figures

Figure 1-1 Prestige Internet Access Application.....	1-9
Figure 1-2 Firewall Application.....	1-10
Figure 1-3 VPN Application.....	1-11
Figure 1-4 Prestige LAN-to-LAN Application.....	1-12
Figure 2-1 Password Screen.....	2-1
Figure 2-2 Web Configurator SITE MAP Screen.....	2-2
Figure 2-3 Example Xmodem Upload.....	2-4
Figure 3-1 Wizard Screen 1.....	3-3
Figure 3-2 Internet Connection with PPPoE.....	3-6
Figure 3-3 Internet Connection with RFC 1483.....	3-8
Figure 3-4 Internet Connection with ENET ENCAP.....	3-9
Figure 3-5 Internet Connection with PPPoA.....	3-10
Figure 3-6 Wizard Screen 3.....	3-12
Figure 3-7 Wizard: LAN Configuration.....	3-13
Figure 3-8 Wizard Screen 4.....	3-14
Figure 4-1 Password.....	4-1
Figure 5-1 LAN and WAN IP Addresses.....	5-1
Figure 5-2 LAN.....	5-4
Figure 6-1 RTS Threshold.....	6-2
Figure 6-2 Prestige Wireless Security Levels.....	6-3
Figure 6-3 Wireless.....	6-4
Figure 6-4 MAC Address Filter.....	6-7
Figure 6-5 EAP Authentication.....	6-10
Figure 6-6 802.1x.....	6-10
Figure 6-7 Local User Database.....	6-13
Figure 6-8 RADIUS.....	6-14
Figure 7-1 Example of Traffic Shaping.....	7-4
Figure 7-2 WAN Functions.....	7-4
Figure 7-3 WAN DSL Setup.....	7-6
Figure 7-4 ISDN Connection Setup.....	7-10
Figure 7-5 ISDN Dial In Setup.....	7-13
Figure 7-6 Configuring NetCAPI.....	7-15
Figure 7-7 Configuration Example.....	7-17
Figure 7-8 Traffic Redirect Setup Example.....	7-18
Figure 7-9 Traffic Redirect WAN Setup.....	7-19
Figure 7-10 Traffic Redirect LAN Setup.....	7-20
Figure 7-11 WAN Backup Setup.....	7-21
Figure 8-1 How NAT Works.....	8-3

Figure 8-2 NAT Application With IP Alias	8-4
Figure 8-3 Multiple Servers Behind NAT Example	8-8
Figure 8-4 NAT Mode	8-8
Figure 8-5 Edit SUA/NAT Server Set	8-10
Figure 8-6 Address Mapping Rules	8-11
Figure 8-7 Address Mapping Rule Edit	8-13
Figure 9-1 DDNS	9-2
Figure 10-1 Time/Date	10-1
Figure 11-1 Prestige Firewall Application	11-3
Figure 11-2 Three-Way Handshake	11-5
Figure 11-3 SYN Flood	11-5
Figure 11-4 Smurf Attack	11-6
Figure 11-5 Stateful Inspection	11-8
Figure 12-1 Enabling the Firewall	12-1
Figure 12-2 Attack Alert	12-4
Figure 13-1 LAN to WAN Traffic	13-4
Figure 13-2 WAN to LAN Traffic	13-5
Figure 13-3 Firewall Rules Summary: First Screen	13-6
Figure 13-4 Creating/Editing A Firewall Rule	13-11
Figure 13-5 Adding/Editing Source and Destination Addresses	13-13
Figure 13-6 Timeout	13-14
Figure 14-1 Customized Services	14-1
Figure 14-2 Creating/Editing A Customized Service	14-2
Figure 14-3 Configure Source IP Example	14-4
Figure 14-4 Customized Service for MyService Example	14-4
Figure 14-5 Syslog Rule Configuration Example	14-5
Figure 14-6 Rule Summary Example	14-6
Figure 15-1 Content Filter: Keyword	15-2
Figure 15-2 Content Filter: Schedule	15-3
Figure 15-3 Content Filter: Trusted	15-4
Figure 16-1 Encryption and Decryption	16-2
Figure 16-3 IPsec Architecture	16-3
Figure 16-4 Transport and Tunnel Mode IPsec Encapsulation	16-4
Figure 17-1 IPsec Summary Fields	17-3
Figure 17-2 VPN Summary	17-4
Figure 17-3 VPN IKE	17-8
Figure 17-4 Two Phases to Set Up the IPsec SA	17-13
Figure 17-5 VPN IKE: Advanced	17-15
Figure 17-6 Manual Setup	17-19
Figure 17-7 SA Monitor	17-23
Figure 17-8 Global Setting	17-24

Figure 17-9 Telecommuters Sharing One VPN Rule Example.....	17-26
Figure 17-10 Telecommuters Using Unique VPN Rules Example	17-27
Figure 18-1 Telnet Configuration on a TCP/IP Network	18-2
Figure 18-2 Remote Management	18-3
Figure 19-1 Configuring UPnP.....	19-2
Figure 20-1 Log Settings	20-2
Figure 20-2 View Logs	20-4
Figure 20-3 E-mail Log Example	20-6
Figure 21-1 Application-based Bandwidth Management Example	21-2
Figure 21-2 Subnet-based Bandwidth Management Example	21-3
Figure 21-3 Application and Subnet-based Bandwidth Management Example.....	21-4
Figure 21-4 Bandwidth Allotment Example	21-6
Figure 21-5 Maximize Bandwidth Usage Example.....	21-6
Figure 21-6 Bandwidth Borrowing Example.....	21-8
Figure 21-7 Bandwidth Manager: Summary	21-10
Figure 21-8 Bandwidth Manager: Class Setup	21-12
Figure 21-9 Bandwidth Manager: Class Configuration	21-14
Figure 21-10 Bandwidth Management Statistics	21-17
Figure 21-11 Bandwidth Manager Monitor	21-18
Figure 22-1 System Status	22-2
Figure 22-2 System Status: Show Statistics.....	22-4
Figure 22-3 DHCP Table	22-6
Figure 22-4 Association List.....	22-7
Figure 22-5 Channel Usage Table.....	22-8
Figure 22-6 Diagnostic General.....	22-10
Figure 22-7 Diagnostic DSL Line.....	22-11
Figure 22-8 Diagnostic ISDN Line.....	22-13
Figure 22-9 Firmware Upgrade	22-15
Figure 22-10 Network Temporarily Disconnected.....	22-16
Figure 22-11 Error Message	22-16
Figure 23-1 Login Screen	23-2
Figure 23-2 Prestige 653 SMT Menu Overview.....	23-3
Figure 23-3 SMT Main Menu.....	23-5
Figure 23-4 Menu 23 System Password	23-6
Figure 24-1 Menu 1 General Setup.....	24-2
Figure 24-2 Menu 1.1 Configure Dynamic DNS.....	24-3
Figure 25-1 Menu 2 WAN Backup Setup	25-2
Figure 25-2 Menu 2.1 Traffic Redirect Setup	25-3
Figure 25-3 Menu 2.2 IDN Dial Backup Setup	25-4
Figure 25-4 Router Behind a PABX	25-7
Figure 25-5 Menu 2 ISDN Setup for DSS1	25-8

Figure 25-6 Loopback Test	25-8
Figure 25-7 Menu 2.2.2 NetCAPI Setup	25-9
Figure 25-8 Menu 11.1 ISDN Remote Node Profile.....	25-10
Figure 25-9 Menu 11.2 Remote Node PPP Options.....	25-13
Figure 25-10 Menu 11.3 Remote Node Network Layer Options	25-14
Figure 25-11 Menu 11.4 Remote Node Setup Script	25-17
Figure 25-12 Menu 11.1 Remote Node Profile (Backup ISP).....	25-18
Figure 25-13 Menu 11.5 Dial Backup Remote Node Filter	25-19
Figure 26-1 Menu 3 LAN Setup	26-1
Figure 26-2 Menu 3.1 LAN Port Filter Setup	26-1
Figure 26-3 Menu 3.2 TCP/IP and DHCP Ethernet Setup	26-2
Figure 27-1 Menu 3.5 - Wireless LAN Setup	27-1
Figure 27-2 Menu 3.5.1 WLAN MAC Address Filtering	27-3
Figure 28-1 Physical Network	28-2
Figure 28-2 Partitioned Logical Networks.....	28-2
Figure 28-3 Menu 3.2 TCP/IP and DHCP Setup.....	28-3
Figure 28-4 Menu 3.2.1 IP Alias Setup	28-3
Figure 28-5 Menu 1 General Setup.....	28-4
Figure 28-6 Menu 4 Internet Access Setup	28-5
Figure 29-1 Menu 11 Remote Node Setup.....	29-2
Figure 29-2 Menu 11.1 Remote Node Profile.....	29-3
Figure 29-3 Menu 11.3 Remote Node Network Layer Options	29-6
Figure 29-4 Sample IP Addresses for a TCP/IP LAN-to-LAN Connection	29-8
Figure 29-5 Menu 11.5 Remote Node Filter (RFC 1483 or ENET Encapsulation)	29-9
Figure 29-6 Menu 11.5 Remote Node Filter (PPPoA or PPPoE Encapsulation).....	29-9
Figure 29-7 Menu 11.6 for VC-based Multiplexing.....	29-10
Figure 29-8 Menu 11.6 for LLC-based Multiplexing or PPP Encapsulation	29-10
Figure 29-9 Menu 11.1 Remote Node Profile(ISDN Dial Backup)	29-11
Figure 29-10 Menu 11.1 Remote Node Profile(ISDN Dial In)	29-11
Figure 30-1 Sample Static Routing Topology	30-1
Figure 30-2 Menu 12 Static Route Setup	30-2
Figure 30-3 Menu 12.1 IP Static Route.....	30-2
Figure 30-4 Menu 12.1.1 Edit IP Static Route	30-3
Figure 31-1 Menu 11.1 Remote Node Profile.....	31-2
Figure 31-2 Menu 11.3 Remote Node Network Layer Options	31-2
Figure 31-3 Menu 12.3.1 Edit Bridge Static Route.....	31-3
Figure 32-1 Menu 4 Applying NAT for Internet Access	32-2
Figure 32-2 Menu 11.3 Applying NAT to the Remote Node	32-3
Figure 32-3 Menu 15 NAT Setup.....	32-4
Figure 32-4 Menu 15.1 Address Mapping Sets.....	32-4
Figure 32-5 Menu 15.1.255 SUA Address Mapping Rules.....	32-5

Figure 32-6 Menu 15.1.1 First Set.....	32-6
Figure 32-7 Menu 15.1.1.1 Editing/Configuring an Individual Rule in a Set.....	32-8
Figure 32-8 Menu 15.2 NAT Server Setup	32-9
Figure 32-9 Menu 15.2.1 NAT Server Setup	32-10
Figure 32-10 Multiple Servers Behind NAT Example.....	32-11
Figure 32-11 NAT Example 1	32-12
Figure 32-12 Menu 4 Internet Access & NAT Example	32-12
Figure 32-13 NAT Example 2.....	32-13
Figure 32-14 Menu 15.2.1 Specifying an Inside Server	32-13
Figure 32-15 NAT Example 3	32-14
Figure 32-16 Example 3: Menu 11.3	32-15
Figure 32-17 Example 3: Menu 15.1.1.1	32-16
Figure 32-18 Example 3: Final Menu 15.1.1	32-16
Figure 32-19 NAT Example 4.....	32-17
Figure 32-20 Example 4: Menu 15.1.1.1 Address Mapping Rule.....	32-18
Figure 32-21 Example 4: Menu 15.1.1 Address Mapping Rules	32-18
Figure 33-1 Menu 21.2 Firewall Setup	33-2
Figure 34-1 Outgoing Packet Filtering Process	34-2
Figure 34-2 Filter Rule Process	34-3
Figure 34-3 Menu 21 Filter Set Configuration	34-4
Figure 34-4 NetBIOS_WAN Filter Rules Summary.....	34-5
Figure 34-5 NetBIOS_LAN Filter Rules Summary.....	34-5
Figure 34-6 IGMP Filter Rules Summary.....	34-5
Figure 34-7 Menu 21 Filter Set Configuration	34-6
Figure 34-8 PPPoE Filter Rules Summary	34-7
Figure 34-9 TEL_FTP_WEB_SNM Filter Rules Summary.....	34-7
Figure 34-10 Menu 21.1.x.1 TCP/IP Filter Rule.....	34-9
Figure 34-11 Executing an IP Filter.....	34-12
Figure 34-12 Menu 21.1.5.1 Generic Filter Rule	34-13
Figure 34-13 Protocol and Device Filter Sets.....	34-15
Figure 34-14 Sample Telnet Filter	34-16
Figure 34-15 Menu 21.1.6.1 Sample Filter.....	34-17
Figure 34-16 Menu 21.1.6.1 Sample Filter Rules Summary	34-18
Figure 34-17 Filtering Ethernet Traffic.....	34-19
Figure 34-18 Filtering Remote Node Traffic	34-20
Figure 35-1 SNMP Management Model.....	35-1
Figure 35-2 Menu 22 SNMP Configuration	35-3
Figure 36-1 Menu 23 System Security	36-1
Figure 36-2 Menu 23 System Security	36-1
Figure 36-3 Menu 23.2 System Security : RADIUS Server	36-2
Figure 36-4 Menu 23 System Security	36-3

Figure 36-5 Menu 23.4 System Security : IEEE802.1x	36-4
Figure 36-6 Menu 14 Dial-in User Setup	36-6
Figure 36-7 Menu 14.1 Edit Dial-in User	36-6
Figure 37-1 Menu 24 System Maintenance	37-1
Figure 37-2 Menu 24.1 System Maintenance: Status	37-2
Figure 37-3 Menu 24.2 System Information and Console Port Speed	37-3
Figure 37-4 Menu 24.2.1 System Maintenance : Information	37-4
Figure 37-5 Menu 24.2.2 System Maintenance : Change Console Port Speed	37-5
Figure 37-6 Menu 24.3 System Maintenance: Log and Trace	37-6
Figure 37-7 Sample Error and Information Messages	37-6
Figure 37-8 Menu 24.3.2 System Maintenance : Syslog and Accounting	37-7
Figure 37-9 Menu 24.4 System Maintenance : Diagnostic	37-9
Figure 38-1 Telnet in Menu 24.5	38-3
Figure 38-2 FTP Session Example	38-4
Figure 38-3 Menu 24.5 System Maintenance : Backup Configuration	38-6
Figure 38-4 Menu 24.5 System Maintenance : Starting Xmodem Download Screen	38-6
Figure 38-5 Backup Configuration Example	38-7
Figure 38-6 Successful Backup Confirmation Screen	38-7
Figure 38-7 Telnet into Menu 24.6	38-8
Figure 38-8 Restore Using FTP Session Example	38-9
Figure 38-9 System Maintenance : Restore Configuration	38-9
Figure 38-10 System Maintenance : Starting Xmodem Download Screen	38-9
Figure 38-11 Restore Configuration Example	38-10
Figure 38-12 Successful Restoration Confirmation Screen	38-10
Figure 38-13 Telnet Into Menu 24.7.1 Upload System Firmware	38-11
Figure 38-14 Telnet Into Menu 24.7.2 System Maintenance	38-11
Figure 38-15 FTP Session Example of Firmware File Upload	38-12
Figure 38-16 Menu 24.7.1 as seen using the Console Port	38-14
Figure 38-17 Example Xmodem Upload	38-14
Figure 38-18 Menu 24.7.2 as seen using the Console Port	38-15
Figure 38-19 Example Xmodem Upload	38-16
Figure 39-1 Command Mode in Menu 24	39-1
Figure 39-2 Valid Commands	39-2
Figure 39-3 Menu 24.9 System Maintenance : Call Control	39-2
Figure 39-4 Menu 24.9.1 System Maintenance : Budget Management	39-3
Figure 39-5 Menu 24 System Maintenance	39-4
Figure 39-6 Menu 24.10 System Maintenance: Time and Date Setting	39-4
Figure 40-1 Menu 24.11 Remote Management Control	40-2
Figure 41-1 Menu 25 IP Routing Policy Setup	41-2
Figure 41-2 Menu 25.1 IP Routing Policy Setup	41-3
Figure 41-3 Menu 25.1.1 IP Routing Policy	41-4

Figure 41-4 Menu 3.2 TCP/IP and DHCP Ethernet Setup	41-6
Figure 41-5 Menu 11.3 Remote Node Network Layer Options	41-6
Figure 41-6 Example of IP Policy Routing	41-7
Figure 41-7 IP Routing Policy Example	41-8
Figure 41-8 IP Routing Policy Example	41-9
Figure 41-9 Applying IP Policies Example	41-9
Figure 42-1 Menu 26 Schedule Setup	42-1
Figure 42-2 Menu 26.1 Schedule Set Setup	42-2
Figure 42-3 Applying Schedule Set(s) to a Remote Node (PPPoE)	42-4
Figure 43-1 VPN SMT Menu Tree	43-1
Figure 43-2 Menu 27 VPN/IPSec Setup	43-2
Figure 43-3 Menu 27.1 IPSec Summary	43-2
Figure 43-4 Menu 27.1.1 IPSec Setup	43-6
Figure 43-5 Menu 27.1.1.1 IKE Setup	43-11
Figure 43-6 Menu 27.1.1.2 Manual Setup	43-14
Figure 44-1 Menu 27.2 SA Monitor	44-1
Figure 45-1 Configuration Text File Format: Column Descriptions	45-2
Figure 45-2 Invalid Parameter Entered: Command Line Example	45-3
Figure 45-3 Valid Parameter Entered: Command Line Example	45-3
Figure 45-4 Internal SPTGEN FTP Download Example	45-3
Figure 45-5 Internal SPTGEN FTP Upload Example	45-4

List of Tables

Table 3-1 Wizard Screen 1	3-3
Table 3-2 Internet Connection with PPPoE.....	3-7
Table 3-3 Internet Connection with RFC 1483	3-8
Table 3-4 Internet Connection with ENET ENCAP	3-9
Table 3-5 Internet Connection with PPPoA	3-11
Table 3-6 Wizard: LAN Configuration	3-13
Table 4-1 Password.....	4-1
Table 5-1 LAN.....	5-5
Table 6-1 Wireless.....	6-5
Table 6-2 MAC Address Filter.....	6-8
Table 6-3 802.1x	6-11
Table 6-4 Local User Database	6-14
Table 6-5 RADIUS.....	6-15
Table 7-1 WAN Functions.....	7-5
Table 7-2 WAN DSL Setup	7-7
Table 7-3 ISDN Connection Setup.....	7-11
Table 7-4 ISDN Dial In Setup.....	7-14
Table 7-5 Configuring NetCAPI	7-16
Table 7-6 WAN Backup Setup.....	7-22
Table 8-1 NAT Definitions.....	8-1
Table 8-2 NAT Mapping Types	8-5
Table 8-3 Services and Port Numbers	8-7
Table 8-4 NAT Mode	8-9
Table 8-5 Edit SUA/NAT Server Set.....	8-10
Table 8-6 Address Mapping Rules	8-12
Table 8-7 Address Mapping Rule Edit	8-13
Table 9-1 DDNS.....	9-2
Table 10-1 Time/Date.....	10-2
Table 11-1 Common IP Ports	11-4
Table 11-2 ICMP Commands That Trigger Alerts.....	11-6
Table 11-3 Legal NetBIOS Commands.....	11-7
Table 11-4 Legal SMTP Commands	11-7
Table 12-1 Attack Alert.....	12-4
Table 13-1 Firewall Rules Summary: First Screen.....	13-6
Table 13-2 Predefined Services.....	13-8
Table 13-3 Creating/Editing A Firewall Rule.....	13-11
Table 13-4 Adding/Editing Source and Destination Addresses.....	13-13
Table 13-5 Timeout.....	13-14

Table 14-1 Customized Services.....	14-2
Table 14-2 Creating/Editing A Customized Service	14-3
Table 15-1 Content Filter: Keyword.....	15-2
Table 15-2 Content Filter: Schedule.....	15-4
Table 15-3 Content Filter: Trusted.....	15-4
Table 16-1 VPN and NAT.....	16-5
Table 17-1 AH and ESP.....	17-2
Table 17-2 VPN Summary.....	17-4
Table 17-3 Local ID Type and Content Fields.....	17-6
Table 17-4 Peer ID Type and Content Fields.....	17-6
Table 17-5 Matching ID Type and Content Configuration Example	17-6
Table 17-6 Mismatching ID Type and Content Configuration Example.....	17-7
Table 17-7 VPN IKE.....	17-9
Table 17-8 VPN IKE: Advanced.....	17-15
Table 17-9 VPN Manual Setup.....	17-20
Table 17-10 SA Monitor.....	17-23
Table 17-11 Global Setting.....	17-24
Table 17-12 Telecommuter and Headquarters Configuration Example	17-25
Table 18-1 Remote Management.....	18-3
Table 19-1 Configuring UPnP.....	19-2
Table 20-1 Log Settings.....	20-3
Table 20-2 View Logs.....	20-4
Table 20-3 SMTP Error Messages.....	20-5
Table 21-1 Application and Subnet-based Bandwidth Management Example	21-3
Table 21-2 Bandwidth Manager: Summary.....	21-10
Table 21-3 Bandwidth Manager: Class Setup.....	21-12
Table 21-4 Bandwidth Manager: Class Configuration.....	21-14
Table 21-5 Services and Port Numbers.....	21-16
Table 21-6 Bandwidth Management Statistics.....	21-17
Table 21-7 Bandwidth Manager Monitor.....	21-18
Table 22-1 System Status.....	22-3
Table 22-2 System Status: Show Statistics	22-5
Table 22-3 DHCP Table.....	22-6
Table 22-4 Association List.....	22-7
Table 22-5 Channel Usage Table.....	22-9
Table 22-6 Diagnostic General.....	22-10
Table 22-7 Diagnostic DSL Line.....	22-11
Table 22-8 Diagnostic ISDN Line.....	22-13
Table 22-9 Firmware Upgrade.....	22-15
Table 23-1 Main Menu Commands.....	23-4
Table 23-2 Main Menu Summary.....	23-5

Table 24-1 Menu 1 General Setup.....	24-2
Table 24-2 Menu 1.1 Configure Dynamic DNS.....	24-3
Table 25-1 Menu 2 WAN Backup Setup.....	25-2
Table 25-2 Menu 2.1 Traffic Redirect Setup.....	25-4
Table 25-3 Menu 2 ISDN Dial Backup Setup.....	25-5
Table 25-4 Menu 2.2.2 NetCAPi Setup.....	25-9
Table 25-5 Menu 11.1 ISDN Remote Node Profile.....	25-10
Table 25-6 Menu 11.2 Remote Node PPP Options.....	25-13
Table 25-7 Menu 11.2 Remote Node PPP Options.....	25-15
Table 25-8 Menu 11.4 Remote Node Setup Script.....	25-17
Table 26-1 DHCP Ethernet Setup Menu Fields.....	26-3
Table 26-2 TCP/IP Ethernet Setup Menu Fields.....	26-3
Table 27-1 Menu 3.5 - Wireless LAN Setup.....	27-2
Table 27-2 Menu 3.5.1 WLAN MAC Address Filtering.....	27-3
Table 28-1 Menu 3.2.1 IP Alias Setup.....	28-4
Table 28-2 Menu 4 Internet Access Setup.....	28-5
Table 29-1 Menu 11.1 Remote Node Profile.....	29-3
Table 29-2 Menu 11.3 Remote Node Network Layer Options.....	29-6
Table 30-1 Menu 12.1.1 Edit IP Static Route.....	30-3
Table 31-1 Remote Node Network Layer Options : Bridge Fields.....	31-3
Table 31-2 Menu 12.3.1 Edit Bridge Static Route.....	31-3
Table 32-1 Applying NAT in Menus 4 & 11.3.....	32-3
Table 32-2 SUA Address Mapping Rules.....	32-5
Table 32-3 Menu 15.1.1 First Set.....	32-7
Table 32-4 Menu 15.1.1.1 Editing/Configuring an Individual Rule in a Set.....	32-8
Table 34-1 Abbreviations Used in the Filter Rules Summary Menu.....	34-7
Table 34-2 Rule Abbreviations Used.....	34-8
Table 34-3 Menu 21.1.x.1 TCP/IP Filter Rule.....	34-10
Table 34-4 Menu 21.1.5.1 Generic Filter Rule.....	34-14
Table 34-5 Filter Sets Table.....	34-19
Table 35-1 Menu 22 SNMP Configuration.....	35-3
Table 35-2 SNMP Traps.....	35-4
Table 35-3 Ports and Permanent Virtual Circuits.....	35-4
Table 36-1 Menu 23.2 System Security : RADIUS Server.....	36-2
Table 36-2 Menu 23.4 System Security : IEEE802.1x.....	36-4
Table 36-3 Menu 14.1 Edit Dial-in User.....	36-6
Table 37-1 Menu 24.1 System Maintenance: Status.....	37-2
Table 37-2 Menu 24.2.1 System Maintenance : Information.....	37-4
Table 37-3 Menu 24.3.2 System Maintenance : Syslog and Accounting.....	37-7
Table 37-4 Menu 24.4 System Maintenance Menu : Diagnostic.....	37-9
Table 38-1 Filename Conventions.....	38-2

Table 38-2 General Commands for GUI-based FTP Clients	38-4
Table 38-3 General Commands for GUI-based TFTP Clients	38-6
Table 39-1 Menu 24.9.1 System Maintenance : Budget Management	39-3
Table 39-2 Menu 24.10 System Maintenance: Time and Date Setting	39-5
Table 40-1 Menu 24.11 Remote Management Control.....	40-2
Table 41-1 Menu 25.1 IP Routing Policy Setup.....	41-3
Table 41-2 Menu 25.1.1 IP Routing Policy.....	41-4
Table 42-1 Menu 26.1 Schedule Set Setup	42-2
Table 43-1 Menu 27.1 IPSec Summary	43-3
Table 43-2 Menu 27.1.1 IPSec Setup.....	43-6
Table 43-3 Menu 27.1.1.1 IKE Setup	43-12
Table 43-4 Active Protocol: Encapsulation and Security Protocol	43-13
Table 43-5 Menu 27.1.1.2 Manual Setup.....	43-14
Table 44-1 Menu 27.2 SA Monitor	44-2

List of Charts

Chart A-1 Troubleshooting the Start-Up of Your Prestige	A-1
Chart A-2 Troubleshooting the LAN LED	A-1
Chart A-3 Troubleshooting the DSL LED	A-2
Chart A-4 Troubleshooting the LAN Interface	A-2
Chart A-5 Troubleshooting the WAN Interface	A-3
Chart A-6 Troubleshooting Internet Access	A-3
Chart A-7 Troubleshooting the Password	A-4
Chart A-8 Troubleshooting the Web Configurator	A-4
Chart A-9 Troubleshooting Remote Management	A-5
Chart B-1 Classes of IP Addresses	B-1
Chart B-2 Allowed IP Address Range By Class	B-2
Chart B-3 "Natural" Masks	B-2
Chart B-4 Alternative Subnet Mask Notation	B-3
Chart B-5 Subnet 1	B-4
Chart B-6 Subnet 2	B-4
Chart B-7 Subnet 1	B-5
Chart B-8 Subnet 2	B-5
Chart B-9 Subnet 3	B-5
Chart B-10 Subnet 4	B-5
Chart B-11 Eight Subnets	B-6
Chart B-12 Class C Subnet Planning	B-6
Chart B-13 Class B Subnet Planning	B-7
Chart K-1 System Maintenance Logs	K-1
Chart K-2 UPnP Logs	K-2
Chart K-3 Content Filtering Logs	K-2
Chart K-4 Attack Logs	K-3
Chart K-5 Access Logs	K-4
Chart K-6 TCP Reset Logs	K-5
Chart K-7 ICMP Notes	K-5
Chart K-8 Sample IKE Key Exchange Logs	K-8
Chart K-9 Sample IPSec Logs During Packet Transmission	K-10
Chart K-10 RFC-2408 ISAKMP Payload Types	K-11

Preface

Congratulations on your purchase of the Prestige 653HWI Series Router.

Don't forget to register your Prestige online at www.zyxel.com for free future product updates and information.

The Prestige 653 HWI Series consists of two models:

- Wireless Ready, with no external antennae.
- Wireless Built-in, complete with internal wireless LAN card and two external antennae

Your Prestige is easy to install and configure.

About This User's Guide

This manual is designed to guide you through the configuration of your Prestige for its various applications. The web configurator parts of this guide contain background information on features configurable by web configurator. The SMT parts of this guide contain background information solely on features not configurable by web configurator.

Use the web configurator, System Management Terminal (SMT) or command interpreter interface to configure your Prestige. Not all features can be configured through all interfaces.

Related Documentation

- Supporting Disk
Refer to the included CD for support documents.
- Compact Guide or Read Me First
The Compact Guide or Read Me First is designed to help you get up and running right away. They contain connection information and instructions on getting started.
- Web Configurator Online Help
Embedded web help for descriptions of individual screens and supplementary information.
- ZyXEL Glossary and Web Site
Please refer to www.zyxel.com for an online glossary of networking terms and additional support documentation.

User Guide Feedback

Help us help you! E-mail all User Guide-related comments, questions or suggestions for improvement to techwriters@zyxel.com.tw or send regular mail to The Technical Writing Team, ZyXEL Communications Corp., 6 Innovation Road II, Science-Based Industrial Park, Hsinchu, 300, Taiwan. Thank you!

Syntax Conventions

- “Enter” means for you to type one or more characters. “Select” or “Choose” means for you to use one predefined choices.
- The SMT menu titles and labels are in **Bold Times New Roman** font. Predefined field choices are in **Bold Arial** font. Command and arrow keys are enclosed in square brackets. [ENTER] means the Enter, or carriage return key; [ESC] means the Escape key and [SPACE BAR] means the Space Bar.
- Mouse action sequences are denoted using a comma. For example, “click the Apple icon, **Control Panels** and then **Modem**” means first click the Apple icon, then point your mouse pointer to **Control Panels** and then click **Modem**.
- For brevity's sake, we will use “e.g.,” as shorthand for “for instance”, and “i.e.,” for “that is” or “in other words” throughout this manual.
- The Prestige 653 HWI may be referred to as the Prestige in this user's guide.

The following section offers some background information on DSL. Skip to *Chapter 1* if you wish to begin working with your router right away.

Introduction to DSL

DSL (Digital Subscriber Line) technology enhances the data capacity of the existing twisted-pair wire that runs between the local telephone company switching offices and most homes and offices. While the wire itself can handle higher frequencies, the telephone switching equipment is designed to cut off signals above 4,000 Hz to filter noise off the voice line, but now everybody is searching for ways to get more bandwidth to improve access to the Web - hence DSL technologies.

There are actually seven types of DSL service, ranging in speeds from 16 Kbits/sec to 52 Mbits/sec. The services are either symmetrical (traffic flows at the same speed in both directions), or asymmetrical (the downstream capacity is higher than the upstream capacity). Asymmetrical services (ADSL) are suitable for Internet users because more information is usually downloaded than uploaded. For example, a simple button click in a web browser can start an extended download that includes graphics and text.

As data rates increase, the carrying distance decreases. That means that users who are beyond a certain distance from the telephone company's central office may not be able to obtain the higher speeds.

A DSL connection is a point-to-point dedicated circuit, meaning that the link is always up and there is no dialing required.

Introduction to ADSL

It is an asymmetrical technology, meaning that the downstream data rate is much higher than the upstream data rate. As mentioned, this works well for a typical Internet session in which more information is downloaded, for example, from Web servers, than is uploaded. ADSL operates in a frequency range that is above the frequency range of voice services, so the two systems can operate over the same cable.

Part I:

Getting Started

This part is structured as a step-by-step guide to help you access your Prestige. It covers key features and applications, accessing the web configurator and configuring the wizard screens for initial setup.

Chapter 1

Getting To Know Your Prestige

This chapter describes the key features and applications of your Prestige.

1.1 Introducing the Prestige 653HWI

Your Prestige integrates high-speed 10/100Mbps auto-negotiating LAN interface(s), a high-speed ADSL port and an ISDN Interface into a single package. The Prestige is ideal for high-speed Internet browsing and making LAN-to-LAN connections to remote networks. By integrating DSL and NAT, the Prestige provides ease of installation and Internet access. The Prestige is also a complete security solution with a robust firewall and VPN capability.

What's more, the Prestige provides an optional wireless LAN connectivity allowing users to enjoy the convenience and mobility of working anywhere within the coverage area.

Models includes in this series at the time of writing are:

- P653HWI-11
- P653HWI-13
- P653HWI-17

Models ending in "1", for example P653HWI-11, denote a device that works over the analog telephone system, POTS (Plain Old Telephone Service). Models ending in "3" denote a device that works over ISDN (Integrated Synchronous Digital Network). Models ending in "7" denote a device that works over T-ISDN (UR-2).

Only use firmware for your Prestige's specific model. Refer to the label on the bottom of your Prestige.

Each model has two types:

- Wireless ready, with no external antenna. You can only (at the time of writing) insert the ZyAIR G-100 into this slot. However, any IEEE 802.11b or IEEE 802.11g wireless client can associate with the Prestige.
- Wireless Built-in, complete with internal wireless LAN card and two external antennas.

The web browser-based Graphical User Interface provides easy management and is totally independent of the operating system platform you use.

1.2 Features of the Prestige

Your Prestige is packed with a number of features that give it the flexibility to provide a complete networking solution for almost any user. These include Wireless LAN, four-port LAN switch and bandwidth management.

- **High Speed Internet Access**

Your Prestige ADSL router can support downstream transmission rates of up to 8Mbps and upstream transmission rates of 832 Kbps.

- **IPSec VPN Capability**

Establish a Virtual Private Network (VPN) to connect with business partners and branch offices using data encryption and the Internet to provide secure communications without the expense of leased site-to-site lines. The Prestige's VPN is based on the IPSec standard and is fully interoperable with other IPSec-based VPN products. The Prestige supports up to ten VPN connections.

- **Firewall**

The Prestige is a stateful inspection firewall with DoS (Denial of Service) protection. By default, when the firewall is activated, all incoming traffic from the WAN to the LAN is blocked unless it is initiated from the LAN. The Prestige firewall supports TCP/UDP inspection, DoS detection and prevention, real time alerts, reports and logs.

You can configure most features of the Prestige via SMT but we recommend you configure the firewall and content filters using the web configurator.

- **Content Filtering**

Content filtering allows you to block access to forbidden Internet web sites, schedule when the Prestige should perform the filtering and give trusted LAN IP addresses unfiltered Internet access.

- **Wireless Built-in**

The Wireless Built-in model comes with two 2dBi detachable antennae.

- **IEEE 802.11g Wireless LAN Standard**

IEEE 802.11g is fully compatible with the IEEE 802.11b standard. This means an IEEE 802.11b radio card can interface directly with an IEEE 802.11g access point (and vice versa) at 11 Mbps or lower depending on range. IEEE 802.11g has several intermediate rate steps between the maximum and minimum data rates. The IEEE 802.11g data rate and modulation are as follows:

IEEE 802.11G	
Data Rate (Mbps)	Data Rate (Mbps)
1 ~ 54	1 ~ 54

The Prestige may be prone to RF (Radio Frequency) interference from other 2.4 GHz devices such as microwave ovens, wireless phones, Bluetooth enabled devices, and other wireless LANs.

● Wireless LAN MAC Address Filtering

Your Prestige can check the MAC addresses of wireless stations against a list of allowed or denied MAC addresses.

● WEP Encryption

WEP (Wired Equivalent Privacy) encrypts data frames before transmitting over the wireless network to help keep network communications private.

● Traffic Redirect

Traffic redirect forwards WAN traffic to a backup gateway when the Prestige cannot connect to the Internet, thus acting as an auxiliary if your regular WAN connection fails.

● ISDN Interface

◆ Call scheduling

The Prestige can manage a remote node and dictate when a remote node should be called and for how long.

◆ Budget Control

Budget management allows you to set a limit on the total outgoing call time of the Prestige within certain times. When the total outgoing call time exceeds the limit, the current call will be dropped and any future outgoing calls will be blocked.

◆ DSS1 Switch Type

◆ Bandwidth-On-Demand

The Prestige dynamically allocates bandwidth by dialing and dropping connections according to traffic demand.

◆ PPP Multilink

The router can bundle multiple links in a single connection using PPP Multilink Protocol (MP). The number of links can be either statically configured or dynamically managed based on traffic demand.

◆ Remote Management

You can remotely access the Prestige for management via an idle ISDN B-channel.

◆ ISDN Router

When ADSL is not available, the Prestige can act as an ISDN router.

◆ Data Compression

Your router incorporates Stac data compression to speed up data transfer. Stac is the de facto standard of data compression over PPP links.

◆ Data Link Connections

The router supports two types of ISDN Data Link Connections: point-to-multipoint and point-to-point.

◆ ISDN Basic Rate Interface (BRI) Support

The router supports a single BRI. The BRI offers two 64 Kbps channels, which can be used independently for two destinations or be bundled to speed up data transfer.

● Incoming Call Support

In addition to making outgoing calls, you can configure the router to act as a remote access server for telecommuting employees.

● Outgoing Data Call Bumping Support

Call bumping is a feature that allows the router to manage an MP (Multilink Protocol) bundle dynamically, dropping or reconnecting a channel in a bundle when necessary.

● Dial-on-Demand

The Dial-on-Demand feature allows the router to automatically place a call to a remote gateway based on the triggering packet's destination without user intervention.

● Bandwidth Management

Bandwidth management allows you to allocate network resources according to defined policies. This policy-based bandwidth allocation helps your network to better handle real-time applications such as Voice-over-IP (VoIP).

- **Universal Plug and Play (UPnP)**

Using the standard TCP/IP protocol, the Prestige and other UPnP enabled devices can dynamically join a network, obtain an IP address and convey its capabilities to other devices on the network.

- **PPPoE Support (RFC2516)**

PPPoE (Point-to-Point Protocol over Ethernet) emulates a dial-up connection. It allows your ISP to use their existing network configuration with newer broadband technologies such as ADSL. The PPPoE driver on the Prestige is transparent to the computers on the LAN, which see only Ethernet and are not aware of PPPoE thus saving you from having to manage PPPoE clients on individual computers.

- **Network Address Translation (NAT)**

Network Address Translation (NAT) allows the translation of an Internet protocol address used within one network (for example a private IP address used in a local network) to a different IP address known within another network (for example a public IP address used on the Internet).

- **10/100M Auto-negotiating Ethernet/Fast Ethernet Interface(s)**

This auto-negotiation feature allows the Prestige to detect the speed of incoming transmissions and adjust appropriately without manual intervention. It allows data transfer of either 10 Mbps or 100 Mbps in either half-duplex or full-duplex mode depending on your Ethernet network.

- **Auto-crossover 10/100 Mbps Ethernet Interface(s)**

These interfaces automatically adjust to either a crossover or straight-through Ethernet cable.

- **LAN/DMZ Interface**

The Prestige provides a LAN port that can function as a virtual DeMilitarized Zone (DMZ) port. Public servers (Web, FTP, etc.) attached to the DMZ port are visible to the outside world (while still being protected from DoS (Denial of Service) attacks such as SYN flooding and Ping of Death) and can also be accessed from the secure LAN.

- **Dynamic DNS Support**

With Dynamic DNS support, you can have a static hostname alias for a dynamic IP address, allowing the host to be more easily accessible from various locations on the Internet. You must register for this service with a Dynamic DNS service provider.

- **Multiple PVC (Permanent Virtual Circuits) Support**

Your Prestige supports up to 8 PVC's.

● **ADSL Transmission Rate Standards**

- ◆ Full-Rate (ANSI T1.413, Issue 2; G.dmt (G.992.1) with line rate support of up to 8 Mbps downstream and 832 Kbps upstream.
- ◆ G.lite (G.992.2) with line rate support of up to 1.5Mbps downstream and 512Kbps upstream.
- ◆ Supports Multi-Mode standard (ANSI T1.413, Issue 2; G.dmt (G.992.1); G.lite (G992.2)).
- ◆ TCP/IP (Transmission Control Protocol/Internet Protocol) network layer protocol.
- ◆ ATM Forum UNI 3.1/4.0 PVC.
- ◆ Supports up to 8 PVCs (UBR, CBR, VBR).
- ◆ Multiple Protocol over AAL5 (RFC 1483).
- ◆ PPP over AAL5 (RFC 2364).
- ◆ PPP over Ethernet over AAL5 (RFC 2516).
- ◆ RFC 1661.
- ◆ PPP over PAP (RFC 1334).
- ◆ PPP over CHAP (RFC 1994).

● **Protocol Support**

◆ DHCP Support

DHCP (Dynamic Host Configuration Protocol) allows the individual clients (computers) to obtain the TCP/IP configuration at start-up from a centralized DHCP server. The Prestige has built-in DHCP server capability enabled by default. It can assign IP addresses, an IP default gateway and DNS servers to DHCP clients. The Prestige can now also act as a surrogate DHCP server (DHCP Relay) where it relays IP address assignment from the actual real DHCP server to the clients.

◆ IP Alias

IP Alias allows you to partition a physical network into logical networks over the same Ethernet interface. The Prestige supports three logical LAN interfaces via its single physical Ethernet interface with the Prestige itself as the gateway for each LAN network.

◆ IP Policy Routing (IPPR)

Traditionally, routing is based on the destination address only and the router takes the shortest path to forward a packet. IP Policy Routing (IPPR) provides a mechanism to override the default routing behavior and alter the packet forwarding based on the policy defined by the network administrator.

◆ PPP (Point-to-Point Protocol) link layer protocol.

- ◆ Transparent bridging for unsupported network layer protocols.
- ◆ RIP I/RIP II
- ◆ IGMP Proxy
- ◆ ICMP support
- ◆ ATM QoS support
- ◆ MIB II support (RFC 1213)

● **Networking Compatibility**

Your Prestige is compatible with the major ADSL DSLAM (Digital Subscriber Line Access Multiplexer) providers, making configuration as simple as possible for you.

● **Multiplexing**

The Prestige supports VC-based and LLC-based multiplexing.

● **Encapsulation**

The Prestige supports PPPoA (RFC 2364 - PPP over ATM Adaptation Layer 5), RFC 1483 encapsulation over ATM, MAC encapsulated routing (ENET encapsulation) as well as PPP over Ethernet (RFC 2516).

● **Network Management**

- ◆ Menu driven SMT (System Management Terminal) management
- ◆ Embedded web configurator
- ◆ CLI (Command Line Interpreter)
- ◆ Remote Management via Telnet or Web.
- ◆ SNMP manageable
- ◆ DHCP Server/Client/Relay
- ◆ Built-in Diagnostic Tools
- ◆ Syslog
- ◆ Telnet Support (Password-protected telnet access to internal configuration manager)
- ◆ TFTP/FTP server, firmware upgrade and configuration backup/support supported
- ◆ Supports OAM F4/F5 loop-back, AIS and RDI OAM cells

- **Other PPPoE Features**

- ◆ PPPoE idle time out
- ◆ PPPoE Dial on Demand

- **Diagnostics Capabilities**

The Prestige can perform self-diagnostic tests. These tests check the integrity of the following circuitry:

- ◆ FLASH memory
- ◆ ADSL circuitry
- ◆ ISDN circuitry
- ◆ RAM
- ◆ LAN port

- **Packet Filters**

The Prestige's packet filtering functions allows added network security and management.

- **Ease of Installation**

Your Prestige is designed for quick, intuitive and easy installation.

- **Housing**

Your Prestige's compact and ventilated housing minimizes space requirements making it easy to position anywhere in your busy office.

1.3 Applications for the Prestige

Here are some example uses for which the Prestige is well suited.

1.3.1 Internet Access

The Prestige is the ideal high-speed Internet access solution. Your Prestige supports the TCP/IP protocol, which the Internet uses exclusively. It is compatible with all major ADSL DSLAM (Digital Subscriber Line Access Multiplexer) providers. A DSLAM is a rack of DSL line cards with data multiplexed into a backbone network interface/connection. Think of it as the equivalent of a modem rack for ADSL. In addition, you can insert an optional wireless PCMICA card into the Prestige and allow wireless clients access to your network resources. A typical Internet access application is shown below.

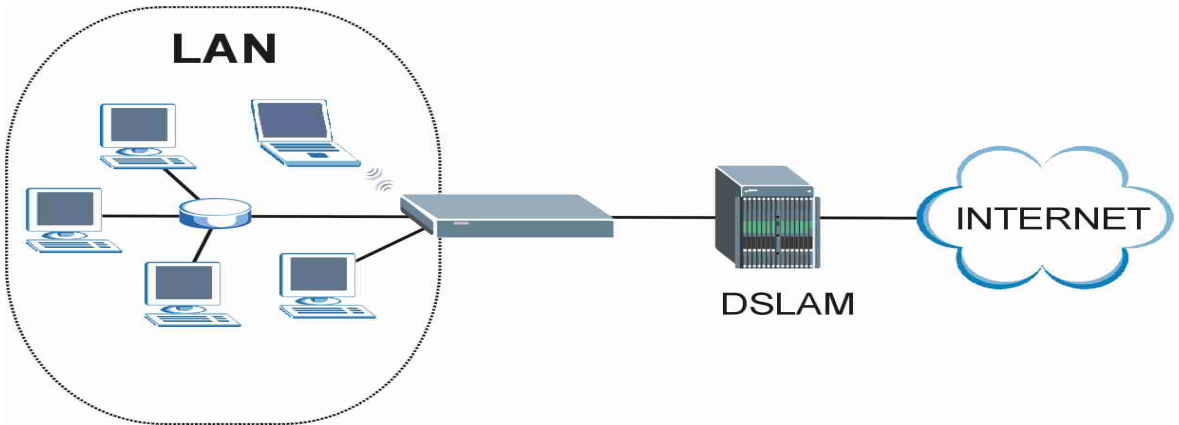

Figure 1-1 Prestige Internet Access Application

Internet Single User Account

For a SOHO (Small Office/Home Office) environment, your Prestige offers the Single User Account (SUA) feature that allows multiple users on the LAN (Local Area Network) to access the Internet concurrently for the cost of a single IP address.

1.3.2 Firewall for Secure Broadband Internet Access

The Prestige provides protection from attacks by Internet hackers. By default, the firewall blocks all incoming traffic from the WAN. The firewall supports TCP/UDP inspection and DoS (Denial of Services) detection and prevention, as well as real time alerts, reports and logs.

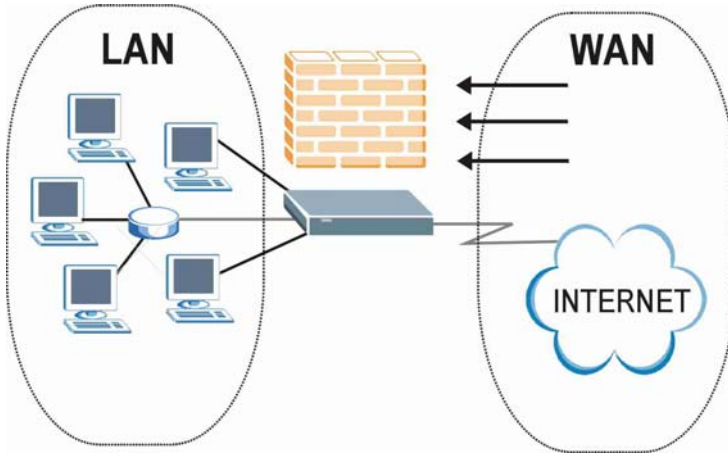

Figure 1-2 Firewall Application

1.3.3 VPN Application

The Prestige's VPN feature makes it an ideal cost-effective way to connect branch offices and business partners over the Internet without the need (and expense) for leased lines between sites. VPN ensures the privacy and integrity of your data transmissions.

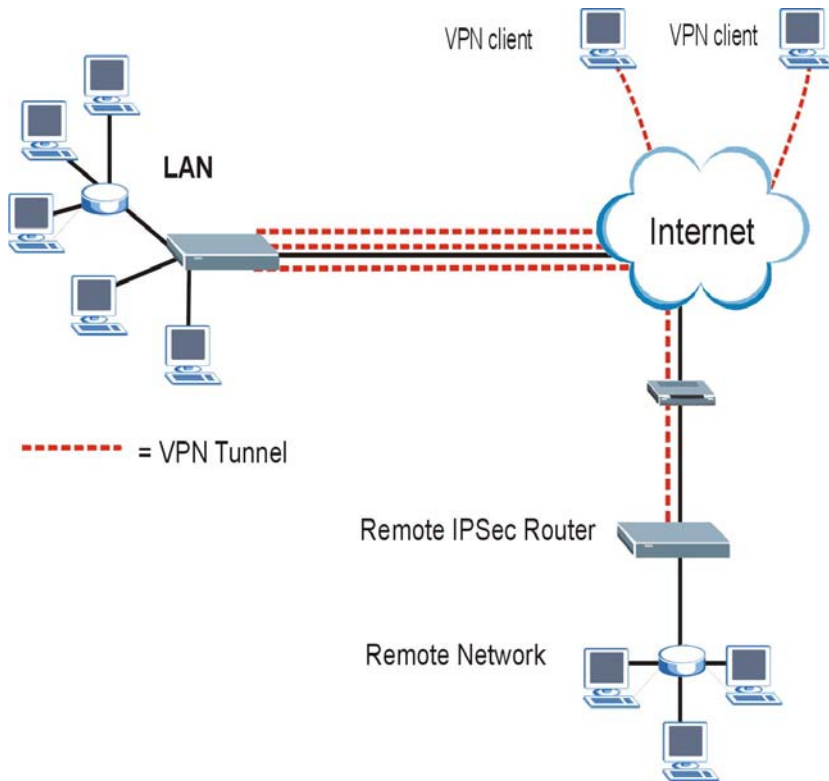

Figure 1-3 VPN Application

1.3.4 LAN to LAN Application

You can use the Prestige to connect two geographically dispersed networks over the ADSL line. A typical LAN-to-LAN application for your Prestige is shown as follows.

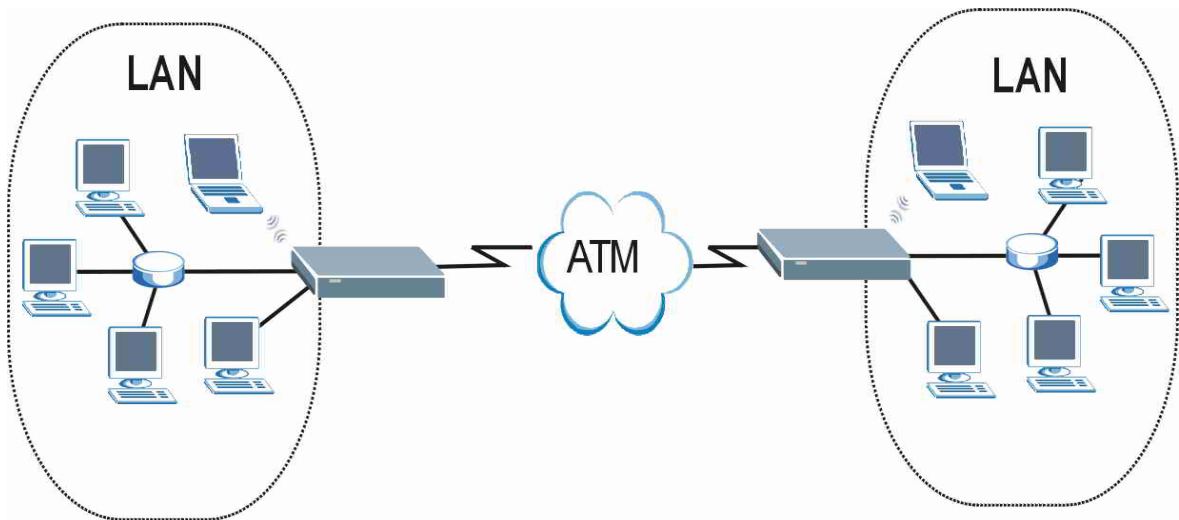

Figure 1-4 Prestige LAN-to-LAN Application

Chapter 2

Introducing the Web Configurator

This chapter describes how to access and navigate the web configurator.

2.1 Web Configurator Overview

The embedded web configurator allows you to manage the Prestige from anywhere through a browser such as Microsoft Internet Explorer or Netscape Navigator. Use Internet Explorer 6.0 and later or Netscape Navigator 7.0 and later versions with JavaScript enabled. It is recommended that you set your screen resolution to 1024 by 768 pixels

2.2 Accessing the Prestige Web Configurator

- Step 1.** Make sure your Prestige hardware is properly connected (refer to the *Compact Guide* or *Read Me First*).
- Step 2.** Prepare your computer/computer network to connect to the Prestige (refer to the *Compact Guide* or *Read Me First*).
- Step 3.** Launch your web browser.
- Step 4.** Type "192.168.1.1" as the URL.
- Step 5.** An **Enter Network Password** window displays. Enter the user name ("admin" is the default), password ("1234" is the default) and click **OK**.



Figure 2-1 Password Screen

Step 6. You should now see the **SITE MAP** screen.

The management session automatically times out when the time period set in the Administrator Inactivity Timer field expires (default five minutes). Simply log back into the Prestige if this happens to you.

2.3 Navigating the Prestige Web Configurator

The following summarizes how to navigate the web configurator from the **SITE MAP** screen.

- Select a language from the **Language** drop-down list box.
- Click **Wizard Setup** to begin a series of screens to configure your Prestige for the first time.
- Click a link under **Advanced Setup** to configure advanced Prestige features.
- Click a link under **Maintenance** to see Prestige performance statistics, upload firmware and back up, restore or upload a configuration file.
- Click **SITE MAP** to go to the **Site Map** screen.
- Click **Logout** in the navigation panel when you have finished a Prestige management session.

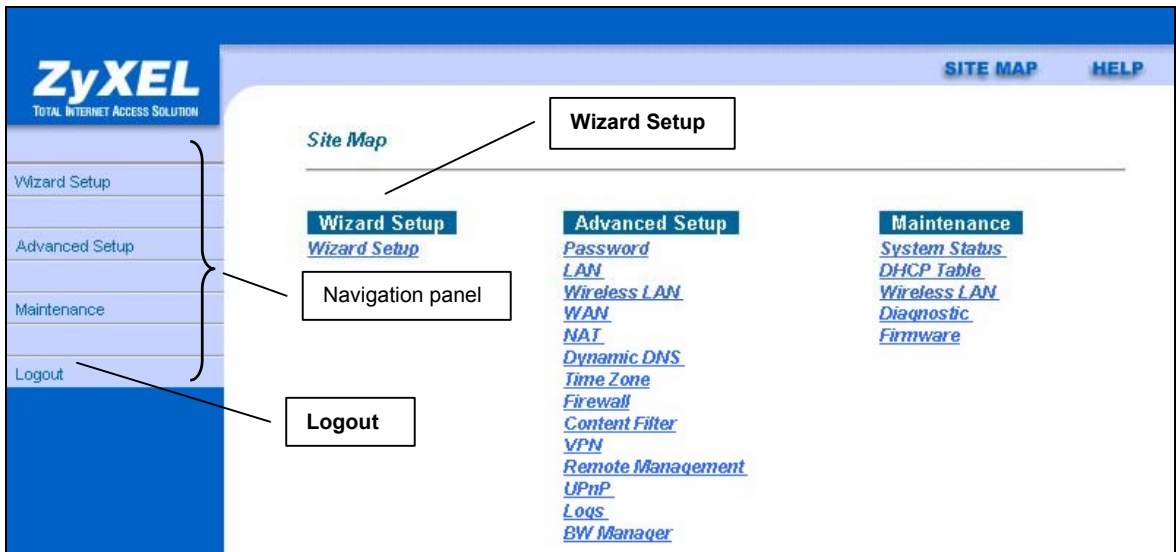

Figure 2-2 Web Configurator SITE MAP Screen

Click the **HELP** icon (located in the top right corner of most screens) to view embedded help.

2.4 Resetting the Prestige

If you forget your password or cannot access the SMT menu, you will need to reload the factory-default configuration file or use the **RESET** button the back of the Prestige. Uploading this configuration file replaces the current configuration file with the factory-default configuration file. This means that you will lose all configurations that you had previously and the speed of the console port will be reset to the default of 9600bps with 8 data bit, no parity, one stop bit and flow control set to none. The password will be reset to "1234", also.

2.4.1 Using The Reset Button

- Step 1.** Make sure the **SYS** LED is on (not blinking).
- Step 2.** Press the **RESET** button for five seconds, and then release it. When the **SYS** LED begins to blink, the defaults have been restored and the Prestige restarts

2.4.2 Uploading a Configuration File Via Console Port

Download the default configuration file from the ZyXEL FTP site, unzip it and save it in a folder.

- Step 1.** Turn off the Prestige, begin a terminal emulation software session and turn on the Prestige again. When you see the message "Press Any key to enter Debug Mode within 3 seconds", press any key to enter debug mode.
- Step 2.** Enter "atlc" after "Enter Debug Mode" message.
- Step 3.** Wait for "Starting XMODEM upload" message before activating Xmodem upload on your terminal. This is an example Xmodem configuration upload using HyperTerminal.
- Step 4.** Click **Transfer**, then **Send File** to display the following screen.

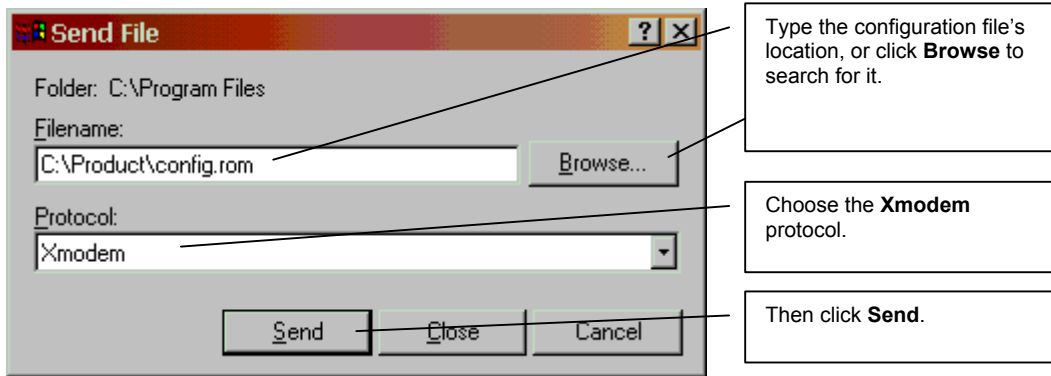

Figure 2-3 Example Xmodem Upload

Step 5. After successful firmware upload, enter "atgo" to restart the router.

Chapter 3

Wizard Setup

This chapter provides information on the Wizard Setup screens in the web configurator.

3.1 Wizard Setup Introduction

Use the Wizard Setup screens to configure your system for Internet access settings and fill in the fields with the information in the *Internet Account Information* table of the *Compact Guide* or *Read Me First*. Your ISP may have already configured some of the fields in the wizard screens for you.

3.2 Encapsulation

Be sure to use the encapsulation method required by your ISP. The Prestige supports the following methods.

3.2.1 ENET ENCAP

The MAC Encapsulated Routing Link Protocol (ENET ENCAP) is only implemented with the IP network protocol. IP packets are routed between the Ethernet interface and the WAN interface and then formatted so that they can be understood in a bridged environment. For instance, it encapsulates routed Ethernet frames into bridged ATM cells. ENET ENCAP requires that you specify a gateway IP address in the **Ethernet Encapsulation Gateway** field in the second wizard screen. You can get this information from your ISP.

3.2.2 PPP over Ethernet

PPPoE provides access control and billing functionality in a manner similar to dial-up services using PPP. The Prestige bridges a PPP session over Ethernet (PPP over Ethernet, RFC 2516) from your computer to an ATM PVC (Permanent Virtual Circuit) which connects to ADSL Access Concentrator where the PPP session terminates. One PVC can support any number of PPP sessions from your LAN. For more information on PPPoE, see the *appendices*.

3.2.3 PPPoA

PPPoA stands for Point to Point Protocol over ATM Adaptation Layer 5 (AAL5). A PPPoA connection functions like a dial-up Internet connection. The Prestige encapsulates the PPP session based on RFC1483 and sends it through an ATM PVC (Permanent Virtual Circuit) to the Internet Service Provider's (ISP) DSLAM (digital access multiplexer). Please refer to RFC 2364 for more information on PPPoA. Refer to RFC 1661 for more information on PPP.

3.2.4 RFC 1483

RFC 1483 describes two methods for Multiprotocol Encapsulation over ATM Adaptation Layer 5 (AAL5). The first method allows multiplexing of multiple protocols over a single ATM virtual circuit (LLC-based multiplexing) and the second method assumes that each protocol is carried over a separate ATM virtual circuit (VC-based multiplexing). Please refer to the RFC for more detailed information.

3.3 Multiplexing

There are two conventions to identify what protocols the virtual circuit (VC) is carrying. Be sure to use the multiplexing method required by your ISP.

3.3.1 VC-based Multiplexing

In this case, by prior mutual agreement, each protocol is assigned to a specific virtual circuit; for example, VC1 carries IP, etc. VC-based multiplexing may be dominant in environments where dynamic creation of large numbers of ATM VCs is fast and economical.

3.3.2 LLC-based Multiplexing

In this case one VC carries multiple protocols with protocol identifying information being contained in each packet header. Despite the extra bandwidth and processing overhead, this method may be advantageous if it is not practical to have a separate VC for each carried protocol, for example, if charging heavily depends on the number of simultaneous VCs.

3.4 VPI and VCI

Be sure to use the correct Virtual Path Identifier (VPI) and Virtual Channel Identifier (VCI) numbers assigned to you. The valid range for the VPI is 0 to 255 and for the VCI is 32 to 65535 (0 to 31 is reserved for local management of ATM traffic). Please see the *appendices* for more information.

3.5 Wizard Setup Configuration: First Screen

In the **SITE MAP** screen click **Wizard Setup** to display the first wizard screen.

Wizard Setup - ISP Parameters for Internet Access

Mode Routing ▾

Encapsulation PPPoE ▾

Multiplex LLC ▾

Virtual Circuit ID

 VPI 8

 VCI 35

Next

Figure 3-1 Wizard Screen 1

The following table describes the fields in this screen.

Table 3-1 Wizard Screen 1

LABEL	DESCRIPTION
Mode	From the Mode drop-down list box, select Routing (default) if your ISP allows multiple computers to share an Internet account. Otherwise select Bridge .
Encapsulation	Select the encapsulation type your ISP uses from the Encapsulation drop-down list box. Choices vary depending on what you select in the Mode field. If you select Bridge in the Mode field, select either PPPoA or RFC 1483 . If you select Routing in the Mode field, select PPPoA , RFC 1483 , ENET ENCAP or PPPoE .
Multiplex	Select the multiplexing method used by your ISP from the Multiplex drop-down list box either VC-based or LLC-based.
Virtual Circuit ID	VPI (Virtual Path Identifier) and VCI (Virtual Channel Identifier) define a virtual circuit. Refer to the appendix for more information.
VPI	Enter the VPI assigned to you. This field may already be configured.
VCI	Enter the VCI assigned to you. This field may already be configured.

Table 3-1 Wizard Screen 1

LABEL	DESCRIPTION
Next	Click this button to go to the next wizard screen. The next wizard screen you see depends on what protocol you chose above. Click on the protocol link to see the next wizard screen for that protocol.

3.6 IP Address and Subnet Mask

Similar to the way houses on a street share a common street name, so too do computers on a LAN share one common network number.

Where you obtain your network number depends on your particular situation. If the ISP or your network administrator assigns you a block of registered IP addresses, follow their instructions in selecting the IP addresses and the subnet mask.

If the ISP did not explicitly give you an IP network number, then most likely you have a single user account and the ISP will assign you a dynamic IP address when the connection is established. If this is the case, it is recommended that you select a network number from 192.168.0.0 to 192.168.255.0 and you must enable the Network Address Translation (NAT) feature of the Prestige. The Internet Assigned Number Authority (IANA) reserved this block of addresses specifically for private use; please do not use any other number unless you are told otherwise. Let's say you select 192.168.1.0 as the network number; which covers 254 individual addresses, from 192.168.1.1 to 192.168.1.254 (zero and 255 are reserved). In other words, the first three numbers specify the network number while the last number identifies an individual computer on that network.

Once you have decided on the network number, pick an IP address that is easy to remember, for instance, 192.168.1.1, for your Prestige, but make sure that no other device on your network is using that IP address.

The subnet mask specifies the network number portion of an IP address. Your Prestige will compute the subnet mask automatically based on the IP address that you entered. You don't need to change the subnet mask computed by the Prestige unless you are instructed to do otherwise.

3.7 IP Address Assignment

A static IP is a fixed IP that your ISP gives you. A dynamic IP is not fixed; the ISP assigns you a different one each time. The Single User Account feature can be enabled or disabled if you have either a dynamic or static IP. However the encapsulation method assigned influences your choices for IP address and ENET ENCAP Gateway.

3.7.1 IP Assignment with PPPoA or PPPoE Encapsulation

If you have a dynamic IP, then the IP Address and ENET ENCAP Gateway fields are not applicable (N/A). If you have a static IP, then you *only* need to fill in the IP Address field and *not* the ENET ENCAP Gateway field.

3.7.2 IP Assignment with RFC 1483 Encapsulation

In this case the IP Address Assignment *must* be static with the same requirements for the IP Address and ENET ENCAP Gateway fields as stated above.

3.7.3 IP Assignment with ENET ENCAP Encapsulation

In this case you can have either a static or dynamic IP. For a static IP you must fill in all the IP Address and ENET ENCAP Gateway fields as supplied by your ISP. However for a dynamic IP, the Prestige acts as a DHCP client on the WAN port and so the IP Address and ENET ENCAP Gateway fields are not applicable (N/A) as the DHCP server assigns them to the Prestige.

3.7.4 Private IP Addresses

Every machine on the Internet must have a unique address. If your networks are isolated from the Internet, for example, only between your two branch offices, you can assign any IP addresses to the hosts without problems. However, the Internet Assigned Numbers Authority (IANA) has reserved the following three blocks of IP addresses specifically for private networks:

10.0.0.0 – 10.255.255.255
172.16.0.0 – 172.31.255.255
192.168.0.0 – 192.168.255.255

You can obtain your IP address from the IANA, from an ISP or it can be assigned from a private network. If you belong to a small organization and your Internet access is through an ISP, the ISP can provide you with the Internet addresses for your local networks. On the other hand, if you are part of a much larger organization, you should consult your network administrator for the appropriate IP addresses.

Regardless of your particular situation, do not create an arbitrary IP address; always follow the guidelines above. For more information on address assignment, please refer to RFC 1597, *Address Allocation for Private Internets* and RFC 1466, *Guidelines for Management of IP Address Space*.

3.8 Nailed-Up Connection (PPP)

A nailed-up connection is a dial-up line where the connection is always up regardless of traffic demand. The Prestige does two things when you specify a nailed-up connection. The first is that idle timeout is disabled. The second is that the Prestige will try to bring up the connection when turned on and whenever the connection is down. A nailed-up connection can be very expensive for obvious reasons.

Do not specify a nailed-up connection unless your telephone company offers flat-rate service or you need a constant connection and the cost is of no concern

3.9 NAT

NAT (Network Address Translation - NAT, RFC 1631) is the translation of the IP address of a host in a packet, for example, the source address of an outgoing packet, used within one network to a different IP address known within another network.

3.10 Wizard Setup Configuration: Second Screen

The second wizard screen varies depending on what mode and encapsulation type you use. All screens shown are with routing mode. Configure the fields and click **Next** to continue.

Wizard Setup - ISP Parameters for Internet Access

Service Name

User Name

Password

IP Address

Obtain an IP Address Automatically

Static IP Address

Connection

Connect on Demand: Max Idle Timeout Secs

Nailed-Up Connection

Network Address Translation

▾

Figure 3-2 Internet Connection with PPPoE

The following table describes the fields in this screen.

Table 3-2 Internet Connection with PPPoE

LABEL	DESCRIPTION
Service Name	Type the name of your PPPoE service here.
User Name	Enter the user name exactly as your ISP assigned. If assigned a name in the form user@domain where domain identifies a service name, then enter both components exactly as given.
Password	Enter the password associated with the user name above.
IP Address	<p>A static IP address is a fixed IP that your ISP gives you. A dynamic IP address is not fixed; the ISP assigns you a different one each time you connect to the Internet. The Single User Account feature can be used with either a dynamic or static IP address.</p> <p>Select Obtain an IP Address Automatically if you have a dynamic IP address; otherwise select Static IP Address and type your ISP assigned IP address in the IP Address text box below.</p>
Connection	<p>Select Connect on Demand when you don't want the connection up all the time and specify an idle time-out (in seconds) in the Max. Idle Timeout field. The default setting selects Connection on Demand with 0 as the idle time-out, which means the Internet session will not timeout.</p> <p>Select Nailed-Up Connection when you want your connection up all the time. The Prestige will try to bring up the connection automatically if it is disconnected.</p> <p>The schedule rule(s) in SMT menu 26 has priority over your Connection settings.</p>
Network Address Translation	Select None , SUA Only or Full Feature from the drop-down list box. Refer to the NAT chapter for more details.
Back	Click Back to go back to the first wizard screen.
Next	Click Next to continue to the next wizard screen.

The screenshot shows a web-based configuration interface titled "Wizard Setup - ISP Parameters for Internet Access". It contains the following elements:

- An "IP Address" label followed by a text input field containing "0.0.0.0".
- A "Network Address Translation" label followed by a dropdown menu currently showing "SUA Only".
- Two buttons at the bottom right: "Back" and "Next".

Figure 3-3 Internet Connection with RFC 1483

The following table describes the fields in this screen.

Table 3-3 Internet Connection with RFC 1483

LABEL	DESCRIPTION
IP Address	This field is available if you select Routing in the Mode field. Type your ISP assigned IP address in this field.
Network Address Translation	Select None , SUA Only or Full Feature from the drop-down list box. Refer to the NAT chapter for more details.
Back	Click Back to go back to the first wizard screen.
Next	Click Next to continue to the next wizard screen.

Wizard Setup - ISP Parameters for Internet Access

IP Address

Obtain an IP Address Automatically
 Static IP Address

IP Address
 Subnet Mask
 ENET ENCAP Gateway

Network Address Translation

SUA Only ▾

Back Next

Figure 3-4 Internet Connection with ENET ENCAP

The following table describes the fields in this screen.

Table 3-4 Internet Connection with ENET ENCAP

LABEL	DESCRIPTION
IP Address	<p>A static IP address is a fixed IP that your ISP gives you. A dynamic IP address is not fixed; the ISP assigns you a different one each time you connect to the Internet. The Single User Account feature can be used with either a dynamic or static IP address.</p> <p>Select Obtain an IP Address Automatically if you have a dynamic IP address; otherwise select Static IP Address and type your ISP assigned IP address in the IP Address text box below.</p>
Subnet Mask	<p>Enter a subnet mask in dotted decimal notation.</p> <p>Refer to the <i>IP Subnetting</i> appendix to calculate a subnet mask If you are implementing subnetting.</p>
ENET ENCAP Gateway	<p>You must specify a gateway IP address (supplied by your ISP) when you use ENET ENCAP in the Encapsulation field in the previous screen.</p>

Table 3-4 Internet Connection with ENET ENCAP

LABEL	DESCRIPTION
Network Address Translation	Select None , SUA Only or Full Feature from the drop-down list box. Refer to the NAT chapter for more details.
Back	Click Back to go back to the first wizard screen.
Next	Click Next to continue to the next wizard screen.

Wizard Setup - ISP Parameters for Internet Access

User Name

Password

IP Address

Obtain an IP Address Automatically

Static IP Address

Connection

Connect on Demand: Max Idle Timeout Secs

Nailed-Up Connection

Network Address Translation

▾

Figure 3-5 Internet Connection with PPPoA

The following table describes the fields in this screen.

Table 3-5 Internet Connection with PPPoA

LABEL	DESCRIPTION
User Name	Enter the login name that your ISP gives you.
Password	Enter the password associated with the user name above.
IP Address	<p>This option is available if you select Routing in the Mode field.</p> <p>A static IP address is a fixed IP that your ISP gives you. A dynamic IP address is not fixed; the ISP assigns you a different one each time you connect to the Internet. The Single User Account feature can be used with either a dynamic or static IP address.</p> <p>Click Obtain an IP Address Automatically if you have a dynamic IP address; otherwise click Static IP Address and type your ISP assigned IP address in the IP Address text box below.</p>
Connection	<p>Select Connect on Demand when you don't want the connection up all the time and specify an idle time-out (in seconds) in the Max. Idle Timeout field. The default setting selects Connection on Demand with 0 as the idle time-out, which means the Internet session will not timeout.</p> <p>Select Nailed-Up Connection when you want your connection up all the time. The Prestige will try to bring up the connection automatically if it is disconnected.</p> <p>The schedule rule(s) in SMT menu 26 has priority over your Connection settings.</p>
Network Address Translation	<p>This option is available if you select Routing in the Mode field.</p> <p>Select None, SUA Only or Full Feature from the drop-down list box. Refer to the NAT chapter for more details.</p>
Back	Click Back to go back to the first wizard screen.
Next	Click Next to continue to the next wizard screen.

3.11 DHCP Setup

DHCP (Dynamic Host Configuration Protocol, RFC 2131 and RFC 2132) allows individual clients to obtain TCP/IP configuration at start-up from a server. You can configure the Prestige as a DHCP server or disable it. When configured as a server, the Prestige provides the TCP/IP configuration for the clients. If you turn DHCP service off, you must have another DHCP server on your LAN, or else the computer must be manually configured.

3.11.1 IP Pool Setup

The Prestige is pre-configured with a pool of 32 IP addresses starting from 192.168.1.33 to 192.168.1.64 for the client machines. This leaves 31 IP addresses, 192.168.1.2 to 192.168.1.32 (excluding the Prestige itself which has a default IP of 192.168.1.1) for other server machines, for example, server for mail, FTP, telnet, web, etc., that you may have.

3.12 Wizard Setup Configuration: Third Screen

- Step 1.** Verify the settings in the screen shown next. To change the LAN information on the Prestige, click **Change LAN Configurations**. Otherwise click **Save Settings** to save the configuration and skip to the section 3.13.

Wizard Setup - ISP Parameters for Internet Access

WAN Information:
 Mode: **Routing**
 Encapsulation: **PPPoE**
 Multiplexing: **LLC**
 VPI/VCI: **8/35**
 Service Name:
 User Name: **user@isp.ch**
 Password: *********
 IP Address: **Obtain an IP Address Automatically**
 NAT: **SUA Only**
 Connect on Demand: **Max Idle Timeout 1500 Secs.**

LAN Information:
 IP Address: **192.168.1.1**
 IP Mask: **255.255.255.0**
 DHCP: **ON**
 Client IP Pool Starting Address: **192.168.1.33**
 Size of Client IP Pool: **32**

Figure 3-6 Wizard Screen 3

- Step 2.** If you want to change your Prestige LAN settings, click **Change LAN Configuration** to display the screen as shown next.

Wizard Setup - ISP Parameters for Internet Access

LAN IP Address

LAN Subnet Mask

DHCP

DHCP Server

Client IP Pool Starting Address

Size of Client IP Pool

Primary DNS Server

Secondary DNS Server

Figure 3-7 Wizard: LAN Configuration

The following table describes the fields in this screen.

Table 3-6 Wizard: LAN Configuration

LABEL	DESCRIPTION
LAN IP Address	Enter the IP address of your Prestige in dotted decimal notation, for example, 192.168.1.1 (factory default). <div style="border: 1px solid black; background-color: #e0e0e0; padding: 5px; margin-top: 10px;"> <p>If you changed the Prestige's LAN IP address, you must use the new IP address if you want to access the web configurator again.</p> </div>
LAN Subnet Mask	Enter a subnet mask in dotted decimal notation.
DHCP	
DHCP Server	From the DHCP Server drop-down list box, select On to allow your Prestige to assign IP addresses, an IP default gateway and DNS servers to computer systems that support the DHCP client. Select Off to disable DHCP server. <p>When DHCP server is used, set the following items:</p>

Table 3-6 Wizard: LAN Configuration

LABEL	DESCRIPTION
Client IP Pool Starting Address	This field specifies the first of the contiguous addresses in the IP address pool.
Size of Client IP Pool	This field specifies the size or count of the IP address pool.
Primary DNS Server	Enter the IP addresses of the DNS servers. The DNS servers are passed to the DHCP clients along with the IP address and the subnet mask.
Secondary DNS Server	As above.
Back	Click Back to go back to the previous screen.
Finish	Click Finish to save the settings and proceed to the next wizard screen.

3.13 Wizard Setup Configuration: Connection Tests

The Prestige automatically tests the connection to the computer(s) connected to the LAN ports. To test the connection from the Prestige to the ISP, click **Start Diagnose**. Otherwise click **Return to Main Menu** to go back to the **Site Map** screen.

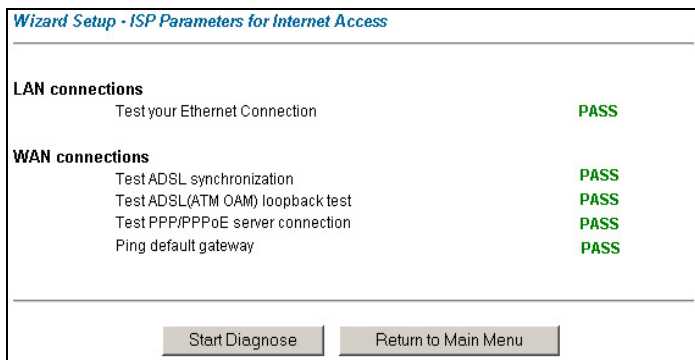
**Figure 3-8 Wizard Screen 4**

3.14 Test Your Internet Connection

Launch your web browser and navigate to www.zyxel.com. Internet access is just the beginning. Refer to the rest of this *User's Guide* for more detailed information on the complete range of Prestige features. If you cannot access the Internet, open the web configurator again to confirm that the Internet settings you configured in the Wizard Setup are correct.

Part II:

Password, LAN, Wireless LAN and WAN

This part covers the password, LAN (Local Area Network), wireless LAN and WAN setup.

Chapter 4 Password Setup

This chapter provides information on the Password screen.

4.1 Password Overview

It is highly recommended that you change the password for accessing the Prestige.

4.2 Configuring Password

To change your Prestige's password (recommended), click **Password**. The screen appears as shown.

Password

Old Password

New Password

Retype to confirm

Please record your new password whenever you change it. The system will lock you out if you have forgotten your password.

Figure 4-1 Password

The following table describes the fields in this screen.

Table 4-1 Password

LABEL	DESCRIPTION
Old Password	Type the default password or the existing password you use to access the system in this field.
New Password	Type the new password in this field.

Table 4-1 Password

LABEL	DESCRIPTION
Retype to Confirm	Type the new password again in this field.
Apply	Click Apply to save your changes back to the Prestige.
Cancel	Click Cancel to begin configuring this screen afresh.

Chapter 5

LAN Setup

This chapter describes how to configure LAN settings.

5.1 LAN Overview

A Local Area Network (LAN) is a shared communication system to which many computers are attached. A LAN is a computer network limited to the immediate area, usually the same building or floor of a building. The LAN screens can help you configure a LAN DHCP server and manage IP addresses.

5.1.1 LANs, WANs and the Prestige

The actual physical connection determines whether the Prestige ports are LAN or WAN ports. There are two separate IP networks, one inside the LAN network and the other outside the WAN network as shown next:

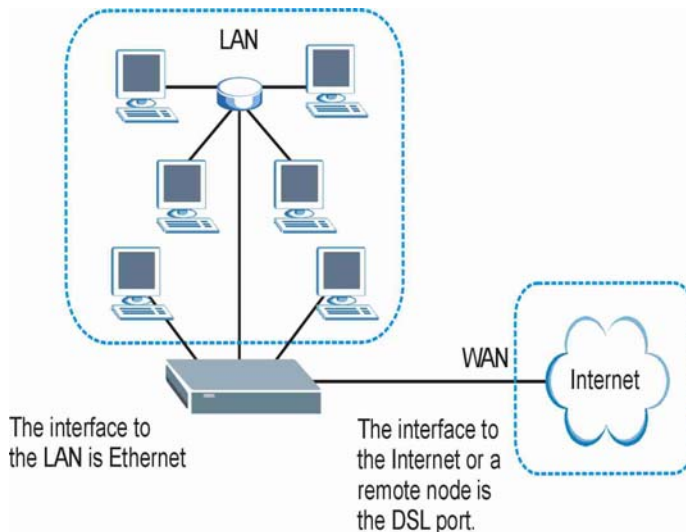

Figure 5-1 LAN and WAN IP Addresses

5.2 DNS Server Address

DNS (Domain Name System) is for mapping a domain name to its corresponding IP address and vice versa, for example, the IP address of *www.zyxel.com* is 204.217.0.2. The DNS server is extremely important because without it, you must know the IP address of a machine before you can access it. The DNS server

addresses that you enter in the DHCP setup are passed to the client machines along with the assigned IP address and subnet mask.

There are two ways that an ISP disseminates the DNS server addresses. The first is for an ISP to tell a customer the DNS server addresses, usually in the form of an information sheet, when s/he signs up. If your ISP gives you the DNS server addresses, enter them in the **DNS Server** fields in **DHCP Setup**, otherwise, leave them blank.

Some ISP's choose to pass the DNS servers using the DNS server extensions of PPP IPCP (IP Control Protocol) after the connection is up. If your ISP did not give you explicit DNS servers, chances are the DNS servers are conveyed through IPCP negotiation. The Prestige supports the IPCP DNS server extensions through the DNS proxy feature.

If the **Primary** and **Secondary DNS Server** fields in **DHCP Setup** are not specified, for instance, left as 0.0.0.0, the Prestige tells the DHCP clients that it itself is the DNS server. When a computer sends a DNS query to the Prestige, the Prestige forwards the query to the real DNS server learned through IPCP and relays the response back to the computer.

Please note that DNS proxy works only when the ISP uses the IPCP DNS server extensions. It does not mean you can leave the DNS servers out of the DHCP setup under all circumstances. If your ISP gives you explicit DNS servers, make sure that you enter their IP addresses in the **DHCP Setup** menu. This way, the Prestige can pass the DNS servers to the computers and the computers can query the DNS server directly without the Prestige's intervention.

5.3 DNS Server Address Assignment

Use DNS (Domain Name System) to map a domain name to its corresponding IP address and vice versa. The DNS server is extremely important because without it, you must know the IP address of a computer before you can access it.

There are two ways that an ISP disseminates the DNS server addresses.

1. The ISP tells you the DNS server addresses, usually in the form of an information sheet, when you sign up. If your ISP gives you DNS server addresses, enter them in the DNS Server fields in DHCP Setup.
2. Leave the DNS Server fields in DHCP Setup blank (for example 0.0.0.0). The Prestige acts as a DNS proxy when this field is blank.

5.4 LAN TCP/IP

The Prestige has built-in DHCP server capability that assigns IP addresses and DNS servers to systems that support DHCP client capability.

5.4.1 Factory LAN Defaults

The LAN parameters of the Prestige are preset in the factory with the following values:

- IP address of 192.168.1.1 with subnet mask of 255.255.255.0 (24 bits)

- DHCP server enabled with 32 client IP addresses starting from 192.168.1.33.

These parameters should work for the majority of installations. If your ISP gives you explicit DNS server address(es), read the embedded web configurator help regarding what fields need to be configured.

5.4.2 IP Address and Subnet Mask

Refer to the *IP Address and Subnet Mask* section in the **Wizard Setup** chapter for this information.

5.4.3 RIP Setup

RIP (Routing Information Protocol) allows a router to exchange routing information with other routers. The **RIP Direction** field controls the sending and receiving of RIP packets. When set to:

1. **Both** - the Prestige will broadcast its routing table periodically and incorporate the RIP information that it receives.
2. **In Only** - the Prestige will not send any RIP packets but will accept all RIP packets received.
3. **Out Only** - the Prestige will send out RIP packets but will not accept any RIP packets received.
4. **None** - the Prestige will not send any RIP packets and will ignore any RIP packets received.

The **Version** field controls the format and the broadcasting method of the RIP packets that the Prestige sends (it recognizes both formats when receiving). **RIP-1** is universally supported; but RIP-2 carries more information. RIP-1 is probably adequate for most networks, unless you have an unusual network topology.

Both **RIP-2B** and **RIP-2M** sends the routing data in RIP-2 format; the difference being that **RIP-2B** uses subnet broadcasting while **RIP-2M** uses multicasting.

5.4.4 Multicast

Traditionally, IP packets are transmitted in one of either two ways - Unicast (1 sender - 1 recipient) or Broadcast (1 sender - everybody on the network). Multicast delivers IP packets to a group of hosts on the network - not everybody and not just 1.

IGMP (Internet Group Multicast Protocol) is a network-layer protocol used to establish membership in a Multicast group - it is not used to carry user data. IGMP version 2 (RFC 2236) is an improvement over version 1 (RFC 1112) but IGMP version 1 is still in wide use. If you would like to read more detailed information about interoperability between IGMP version 2 and version 1, please see sections 4 and 5 of RFC 2236. The class D IP address is used to identify host groups and can be in the range 224.0.0.0 to 239.255.255.255. The address 224.0.0.0 is not assigned to any group and is used by IP multicast computers. The address 224.0.0.1 is used for query messages and is assigned to the permanent group of all IP hosts (including gateways). All hosts must join the 224.0.0.1 group in order to participate in IGMP. The address 224.0.0.2 is assigned to the multicast routers group.

The Prestige supports both IGMP version 1 (**IGMP-v1**) and IGMP version 2 (**IGMP-v2**). At start up, the Prestige queries all directly connected networks to gather group membership. After that, the Prestige periodically updates this information. IP multicasting can be enabled/disabled on the Prestige LAN and/or

WAN interfaces in the web configurator (**LAN**; **WAN**). Select **None** to disable IP multicasting on these interfaces.

5.5 Configuring LAN

Click **LAN** to open the following screen.

LAN - Setup

DHCP

DHCP

Client IP Pool Starting Address

Size of Client IP Pool

Primary DNS Server

Secondary DNS Server

Remote DHCP Server

TCP/IP

IP Address

IP Subnet Mask

RIP Direction

RIP Version

Multicast

Figure 5-2 LAN

The following table describes the fields in this screen.

Table 5-1 LAN

LABEL	DESCRIPTION
DHCP	
DHCP	<p>If set to Server, your Prestige can assign IP addresses, an IP default gateway and DNS servers to Windows 95, Windows NT and other systems that support the DHCP client.</p> <p>If set to None, the DHCP server will be disabled.</p> <p>If set to Relay, the Prestige acts as a surrogate DHCP server and relays DHCP requests and responses between the remote server and the clients. Enter the IP address of the actual, remote DHCP server in the Remote DHCP Server field in this case.</p> <p>When DHCP is used, the following items need to be set:</p>
Client IP Pool Starting Address	This field specifies the first of the contiguous addresses in the IP address pool.
Size of Client IP Pool	This field specifies the size or count of the IP address pool.
Primary DNS Server	Enter the IP addresses of the DNS servers. The DNS servers are passed to the DHCP clients along with the IP address and the subnet mask.
Secondary DNS Server	As above.
Remote DHCP Server	If Relay is selected in the DHCP field above then enter the IP address of the actual remote DHCP server here.
TCP/IP	
IP Address	Enter the IP address of your Prestige in dotted decimal notation, for example, 192.168.1.1 (factory default).
IP Subnet Mask	Type the subnet mask assigned to you by your ISP (if given).
RIP Direction	Select the RIP direction from None , Both , In Only and Out Only .
RIP Version	Select the RIP version from RIP-1 , RIP-2B and RIP-2M .
Multicast	IGMP (Internet Group Multicast Protocol) is a session-layer protocol used to establish membership in a multicast group. The Prestige supports both IGMP version 1 (IGMP-v1) and IGMP-v2 . Select None to disable it.

Table 5-1 LAN

LABEL	DESCRIPTION
Apply	Click this button to save these settings back to the Prestige.
Cancel	Click this button to reset the fields in this screen.

Chapter 6

Wireless LAN Setup

This chapter discusses how to configure Wireless LAN on the Prestige.

6.1 Wireless LAN Overview

This section introduces the wireless LAN and some basic configurations. Wireless LANs can be as simple as two computers with wireless LAN cards communicating in a peer-to-peer network or as complex as a number of computers with wireless LAN cards communicating through access points which bridge network traffic to the wired LAN.

The WLAN screens are only available when a WLAN card is installed.

6.1.1 Additional Installation Requirements for Using 802.1x

- A computer with an IEEE 802.11b/g wireless LAN card and equipped with a web browser (with JavaScript enabled) and/or Telnet.
- A wireless station computer must be running IEEE 802.1x-compliant software. Currently, this is offered in Windows XP.
- An optional network RADIUS server for remote user authentication and accounting.

6.1.2 Channel

The range of radio frequencies used by IEEE 802.11g wireless devices is called a “channel”. Channels available depend on your geographical area. You may have a choice of channels (for your region) so you should use a different channel than an adjacent AP (access point) to reduce interference. Interference occurs when radio signals from different access points overlap causing interference and degrading performance.

Adjacent channels partially overlap however. To avoid interference due to overlap, your AP should be on a channel at least five channels away from a channel that an adjacent AP is using. For example, if your region has 11 channels and an adjacent AP is using channel 1, then you need to select a channel between 6 or 11.

6.1.3 ESS ID

An Extended Service Set (ESS) is a group of access points or wireless gateways connected to a wired LAN on the same subnet. An ESS ID uniquely identifies each set. All access points or wireless gateways and their associated wireless stations in the same set must have the same ESSID.

6.1.4 RTS/CTS

A hidden node occurs when two stations are within range of the same access point, but are not within range of each other. The following figure illustrates a hidden node. Both stations (STA) are within range of the access point (AP) or wireless gateway, but out-of-range of each other, so they cannot “hear” each other, that is they do not know if the channel is currently being used. Therefore, they are considered hidden from each other.

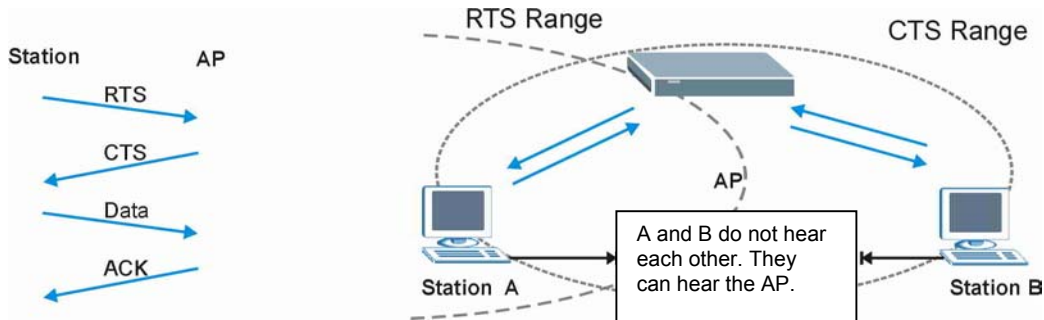

Figure 6-1 RTS Threshold

When station A sends data to the Prestige, it might not know that the station B is already using the channel. If these two stations send data at the same time, collisions may occur when both sets of data arrive at the AP at the same time, resulting in a loss of messages for both stations.

RTS/CTS is designed to prevent collisions due to hidden nodes. An **RTS/CTS** defines the biggest size data frame you can send before an RTS (Request To Send)/CTS (Clear to Send) handshake is invoked.

When a data frame exceeds the **RTS/CTS** value you set (between 0 to 2432 bytes), the station that wants to transmit this frame must first send an RTS (Request To Send) message to the AP for permission to send it. The AP then responds with a CTS (Clear to Send) message to all other stations within its range to notify them to defer their transmission. It also reserves and confirms with the requesting station the time frame for the requested transmission.

Stations can send frames smaller than the specified **RTS/CTS** directly to the AP without the RTS (Request To Send)/CTS (Clear to Send) handshake.

You should only configure **RTS/CTS** if the possibility of hidden nodes exists on your network and the “cost” of resending large frames is more than the extra network overhead involved in the RTS (Request To Send)/CTS (Clear to Send) handshake.

If the **RTS/CTS** value is greater than the **Fragmentation Threshold** value (see next), then the RTS (Request To Send)/CTS (Clear to Send) handshake will never occur as data frames will be fragmented before they reach **RTS/CTS** size.

Enabling the RTS Threshold causes redundant network overhead that could negatively affect the throughput performance instead of providing a remedy.

6.1.5 Fragmentation Threshold

A **Fragmentation Threshold** is the maximum data fragment size (between 256 and 2432 bytes) that can be sent in the wireless network before the Prestige will fragment the packet into smaller data frames.

A large **Fragmentation Threshold** is recommended for networks not prone to interference while you should set a smaller threshold for busy networks or networks that are prone to interference.

If the **Fragmentation Threshold** value is smaller than the **RTS/CTS** value (see previously) you set then the RTS (Request To Send)/CTS (Clear to Send) handshake will never occur as data frames will be fragmented before they reach **RTS/CTS** size.

6.2 Levels of Security

Wireless security is vital to your network to protect wireless communication between wireless stations, access points and the wired network.

The figure below shows the possible wireless security levels on your Prestige. The highest security level relies on EAP (Extensible Authentication Protocol) for authentication and utilizes dynamic Wired Equivalent Privacy (WEP) key exchange. It requires interaction with a RADIUS (Remote Authentication Dial-In User Service) server either on the WAN or your LAN to provide authentication service for wireless stations.

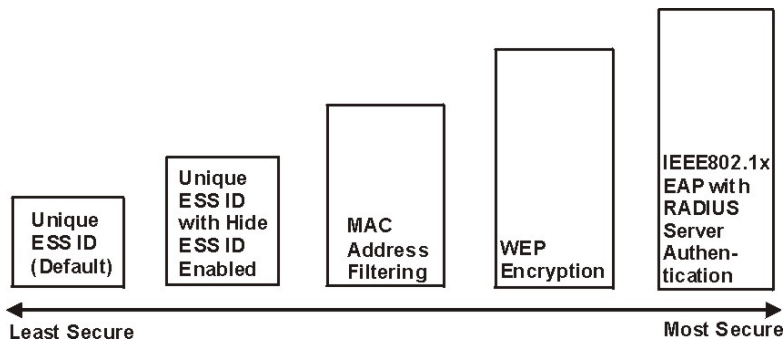

Figure 6-2 Prestige Wireless Security Levels

If you do not enable any wireless security on your Prestige, your network is accessible to any wireless networking device that is within range.

Use the Prestige web configurator to set up your wireless LAN security settings. Refer to the chapter on using the Prestige web configurator to see how to access the web configurator.

6.3 Data Encryption with WEP

WEP encryption scrambles the data transmitted between the wireless stations and the access points to keep network communications private. It encrypts unicast and multicast communications in a network. Both the wireless stations and the access points must use the same WEP key for data encryption and decryption.

Your Prestige allows you to configure up to four 64-bit or 128-bit WEP keys but only one key can be enabled at any one time.

In order to configure and enable WEP encryption; click **Wireless LAN** and **Wireless** to the display the **Wireless** screen.

Refer to the Compact Guide for instructions on how to install a PCMCIA Wireless LAN Card.

Wireless LAN- Wireless

ESSID

Hide ESSID

Channel ID

RTS/CTS Threshold (0 ~ 2432)

Fragmentation Threshold (256 ~ 2432)

WEP Encryption

64-bit WEP: Enter 5 characters or 10 hexadecimal digits ("0-9", "A-F") preceded by 0x for each Key(1-4).
 128-bit WEP: Enter 13 characters or 26 hexadecimal digits ("0-9", "A-F") preceded by 0x for each Key(1-4).

Key1

Key2

Key3

Key4

Figure 6-3 Wireless

The following table describes the fields in this screen.

Table 6-1 Wireless

LABEL	DESCRIPTION
ESSID	The ESSID (Extended Service Set Identification) is a unique name to identify the Prestige in the wireless LAN. Wireless stations associating to the Prestige must have the same ESSID. Enter a descriptive name (up to 32 characters).
Hide ESSID	Select Yes to hide the ESSID in so a station cannot obtain the ESSID through passive scanning. Select No to make the ESSID visible so a station can obtain the ESSID through passive scanning.
Channel ID	The range of radio frequencies used by IEEE 802.11g wireless devices is called a channel. Select a channel from the drop-down list box.
RTS/CTS Threshold	The RTS (Request To Send) threshold (number of bytes) for enabling RTS/CTS handshake. Data with its frame size larger than this value will perform the RTS/CTS handshake. Setting this attribute to be larger than the maximum MSDU (MAC service data unit) size turns off the RTS/CTS handshake. Setting this attribute to zero turns on the RTS/CTS handshake. Enter a value between 0 and 2432.
Fragmentation Threshold	The threshold (number of bytes) for the fragmentation boundary for directed messages. It is the maximum data fragment size that can be sent. Enter a value between 256 and 2432.
WEP Encryption	WEP (Wired Equivalent Privacy) encrypts data frames before transmitting over the wireless network. Select Disable to allow all wireless computers to communicate with the access points without any data encryption. Select 64-bit WEP or 128-bit WEP to use data encryption.
Key 1 to Key 4	The WEP keys are used to encrypt data. Both the Prestige and the wireless stations must use the same WEP key for data transmission. If you chose 64-bit WEP , then enter any 5 ASCII characters or 10 hexadecimal characters ("0-9", "A-F"). If you chose 128-bit WEP , then enter 13 ASCII characters or 26 hexadecimal characters ("0-9", "A-F"). You must configure all four keys, but only one key can be activated at any one time. The default key is key 1.
Back	Click Back to go to the main wireless LAN setup screen.

Table 6-1 Wireless

LABEL	DESCRIPTION
Apply	Click Apply to save your changes back to the Prestige.
Cancel	Click Cancel to begin configuring this screen afresh.

6.4 Configuring MAC Filter

The MAC filter screen allows you to configure the Prestige to give exclusive access to up to 32 devices (Allow Association) or exclude up to 32 devices from accessing the Prestige (Deny Association). Every Ethernet device has a unique MAC (Media Access Control) address. The MAC address is assigned at the factory and consists of six pairs of hexadecimal characters, for example, 00:A0:C5:00:00:02. You need to know the MAC address of the devices to configure this screen.

To change your Prestige's MAC filter settings, click **Wireless LAN**, **MAC Filter** to open the **MAC Filter** screen. The screen appears as shown.

Wireless LAN- MAC Filter

Active

Action

MAC Address	
<input type="text" value="00:00:00:00:00:00"/>	<input type="text" value="00:00:00:00:00:00"/>
<input type="text" value="00:00:00:00:00:00"/>	<input type="text" value="00:00:00:00:00:00"/>
<input type="text" value="00:00:00:00:00:00"/>	<input type="text" value="00:00:00:00:00:00"/>
<input type="text" value="00:00:00:00:00:00"/>	<input type="text" value="00:00:00:00:00:00"/>
<input type="text" value="00:00:00:00:00:00"/>	<input type="text" value="00:00:00:00:00:00"/>
<input type="text" value="00:00:00:00:00:00"/>	<input type="text" value="00:00:00:00:00:00"/>
<input type="text" value="00:00:00:00:00:00"/>	<input type="text" value="00:00:00:00:00:00"/>
<input type="text" value="00:00:00:00:00:00"/>	<input type="text" value="00:00:00:00:00:00"/>
<input type="text" value="00:00:00:00:00:00"/>	<input type="text" value="00:00:00:00:00:00"/>
<input type="text" value="00:00:00:00:00:00"/>	<input type="text" value="00:00:00:00:00:00"/>
<input type="text" value="00:00:00:00:00:00"/>	<input type="text" value="00:00:00:00:00:00"/>
<input type="text" value="00:00:00:00:00:00"/>	<input type="text" value="00:00:00:00:00:00"/>
<input type="text" value="00:00:00:00:00:00"/>	<input type="text" value="00:00:00:00:00:00"/>
<input type="text" value="00:00:00:00:00:00"/>	<input type="text" value="00:00:00:00:00:00"/>
<input type="text" value="00:00:00:00:00:00"/>	<input type="text" value="00:00:00:00:00:00"/>
<input type="text" value="00:00:00:00:00:00"/>	<input type="text" value="00:00:00:00:00:00"/>

Figure 6-4 MAC Address Filter

The following table describes the fields in this menu.

Table 6-2 MAC Address Filter

LABEL	DESCRIPTION
Active	Select Yes from the drop down list box to enable MAC address filtering
Action	Define the filter action for the list of MAC addresses in the MAC address filter table. Select Deny Association to block access to the router, MAC addresses not listed will be allowed to access the router. Select Allow Association to permit access to the router, MAC addresses not listed will be denied access to the router.
MAC Address	Enter the MAC addresses (in XX:XX:XX:XX:XX:XX format) of the wireless station that are allowed or denied access to the Prestige in these address fields.
Back	Click Back to go to the main wireless LAN setup screen.
Apply	Click Apply to save your changes back to the Prestige.
Cancel	Click Cancel to begin configuring this screen afresh.

6.5 Network Authentication

You can set the Prestige and your network to authenticate a wireless station before the wireless station can communicate with the Prestige and the wired network to which the Prestige is connected.

6.5.1 EAP

EAP is an authentication protocol designed originally to run over PPP (Point-to-Point Protocol) frame in order to support multiple types of user authentication. By using EAP to interact with an EAP-compatible RADIUS server, the access point helps a wireless station and a RADIUS server to perform mutual authentication.

6.5.2 RADIUS

RADIUS is based on a client-server model that supports authentication, authorization and accounting. The access point is the client and the server is the RADIUS server. The RADIUS server handles the following tasks:

- **Authentication**

Determines the identity of the users.

- **Authorization**

Determines the network services available to authenticated users once they are connected to the network.

- **Accounting**

Keeps track of the client's network activity.

RADIUS is a simple package exchange in which your Prestige acts as a message relay between the wireless station and the network RADIUS server.

Types of RADIUS Messages

The following types of RADIUS messages are exchanged between the access point and the RADIUS server for user authentication:

- **Access-Request**

Sent by an access point requesting authentication.

- **Access-Reject**

Sent by a RADIUS server rejecting access.

- **Access-Accept**

Sent by a RADIUS server allowing access.

- **Access-Challenge**

Sent by a RADIUS server requesting more information in order to allow access. The access point sends a proper response from the user and then sends another Access-Request message.

The following types of RADIUS messages are exchanged between the access point and the RADIUS server for user accounting:

- **Accounting-Request**

Sent by the access point requesting accounting.

- **Accounting-Response**

Sent by the RADIUS server to indicate that it has started or stopped accounting.

In order to ensure network security, the access point and the RADIUS server use a shared secret key, which is a password, they both know. The key is not sent over the network. In addition to the shared key, password information exchanged is also encrypted to protect the network from unauthorized access.

6.5.3 EAP Authentication Overview

EAP (Extensible Authentication Protocol) is an authentication protocol that runs on top of the IEEE802.1x transport mechanism in order to support multiple types of user authentication. By using EAP to interact with

an EAP-compatible RADIUS server, the access point helps a wireless station and a RADIUS server perform authentication.

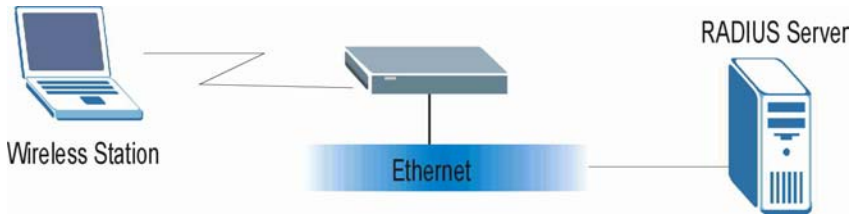

Figure 6-5 EAP Authentication

The details below provide a general description of how IEEE 802.1x EAP authentication works. For an example list of EAP-MD5 authentication steps, see the IEEE 802.1x appendix.

- Step 1.** The wireless station sends a “start” message to the Prestige.
- Step 2.** The Prestige sends a “request identity” message to the wireless station for identity information.
- Step 3.** The wireless station replies with identity information, including username and password.
- Step 4.** The RADIUS server checks the user information against its user profile database and determines whether or not to authenticate the wireless station.

6.6 Configuring 802.1x

To change your Prestige’s authentication settings, click **Wireless LAN, 802.1x**. The screen appears as shown.

The screenshot shows the configuration screen for 802.1x authentication. The title is "Wireless LAN - 802.1x". Below the title, the section "802.1x Authentication" is displayed. The settings are as follows:

Setting	Value
Wireless Port Control	No Authentication Required
ReAuthentication Timer	1800 (In Seconds)
Idle Timeout	3600 (In Seconds)
Authentication Databases	Local User Database Only

At the bottom of the screen, there are three buttons: Back, Apply, and Cancel.

Figure 6-6 802.1x

The following table describes the fields in this screen.

Table 6-3 802.1x

LABEL	DESCRIPTION
Wireless Port Control	<p>To control wireless stations access to the wired network, select a control method from the drop-down list box. Choose from No Authentication Required, Authentication Required and No Access Allowed.</p> <p>No Authentication Required allows all wireless stations access to the wired network without entering user names and passwords. This is the default setting.</p> <p>Authentication Required means that all wireless stations have to enter user names and passwords before access to the wired network is allowed.</p> <p>No Access Allowed blocks all wireless stations access to the wired network.</p>
ReAuthentication Timer	<p>Specify how often wireless stations have to reenter user names and passwords in order to stay connected. This field is activated only when you select Authentication Required in the Wireless Port Control field.</p> <p>Enter a time interval between 10 and 9999 seconds. The default time interval is 1800 seconds (30 minutes).</p> <div style="border: 1px solid black; background-color: #e0e0e0; padding: 5px; text-align: center;"> <p>If wireless station authentication is done using a RADIUS server, the reauthentication timer on the RADIUS server has priority.</p> </div>
Idle Timeout	<p>The Prestige automatically disconnects a wireless station from the wired network after a period of inactivity. The wireless station needs to enter the user name and password again before access to the wired network is allowed.</p> <p>This field is activated only when you select Authentication Required in the Wireless Port Control field. The default time interval is 3600 seconds (1 hour).</p>

Table 6-3 802.1x

LABEL	DESCRIPTION
Authentication Databases	<p>This field is activated only when you select Authentication Required in the Wireless Port Control field.</p> <p>The authentication database contains wireless station login information. The local user database is the built-in database on the Prestige. The RADIUS is an external server. Use this drop-down list box to select which database the Prestige should use (first) to authenticate a wireless station.</p> <p>Before you specify the priority, make sure you have set up the corresponding database(s) correctly.</p> <p>Select Local User Database Only to have the Prestige just check the built-in user database on the Prestige for a client's user name and password.</p> <p>Select RADIUS Only to have the Prestige just check the user database on the specified RADIUS server for a client's user name and password.</p> <p>Select Local first, then RADIUS to have the Prestige first check the user database on the Prestige for a client's user name and password. If the user name is not found, the Prestige checks the user database on the specified RADIUS server.</p> <p>Select RADIUS first, then Local to have the Prestige first check the user database on the specified RADIUS server for a client's user name and password. When the user name is not found or password does not match in the RADIUS server, the Prestige will not check the local user database and the authentication fails. If the Prestige cannot reach the RADIUS server, then the Prestige checks the local user database on the Prestige.</p>
Back	Click Back to go to the main wireless LAN setup screen.
Apply	Click Apply to save these settings back to the Prestige.
Cancel	Click Cancel to begin configuring this screen again.

6.7 Configuring Local User Authentication

By storing user profiles locally, your Prestige is able to authenticate wireless users without interacting with a network RADIUS server. However, there is a limit on the number of users you may authenticate in this way. To change your Prestige's local user database, click **Wireless LAN, Local User Database**. The screen appears as shown.

Wireless LAN - Local User DataBase

#	Active	User Name	Password
1	<input type="checkbox"/>	<input type="text"/>	<input type="text"/>
2	<input type="checkbox"/>	<input type="text"/>	<input type="text"/>
3	<input type="checkbox"/>	<input type="text"/>	<input type="text"/>
4	<input type="checkbox"/>	<input type="text"/>	<input type="text"/>
5	<input type="checkbox"/>	<input type="text"/>	<input type="text"/>
6	<input type="checkbox"/>	<input type="text"/>	<input type="text"/>
7	<input type="checkbox"/>	<input type="text"/>	<input type="text"/>
8	<input type="checkbox"/>	<input type="text"/>	<input type="text"/>
9	<input type="checkbox"/>	<input type="text"/>	<input type="text"/>
10	<input type="checkbox"/>	<input type="text"/>	<input type="text"/>
11	<input type="checkbox"/>	<input type="text"/>	<input type="text"/>
12	<input type="checkbox"/>	<input type="text"/>	<input type="text"/>
13	<input type="checkbox"/>	<input type="text"/>	<input type="text"/>
14	<input type="checkbox"/>	<input type="text"/>	<input type="text"/>
15	<input type="checkbox"/>	<input type="text"/>	<input type="text"/>
16	<input type="checkbox"/>	<input type="text"/>	<input type="text"/>
17	<input type="checkbox"/>	<input type="text"/>	<input type="text"/>
18	<input type="checkbox"/>	<input type="text"/>	<input type="text"/>
19	<input type="checkbox"/>	<input type="text"/>	<input type="text"/>
20	<input type="checkbox"/>	<input type="text"/>	<input type="text"/>
21	<input type="checkbox"/>	<input type="text"/>	<input type="text"/>
22	<input type="checkbox"/>	<input type="text"/>	<input type="text"/>
23	<input type="checkbox"/>	<input type="text"/>	<input type="text"/>
24	<input type="checkbox"/>	<input type="text"/>	<input type="text"/>
25	<input type="checkbox"/>	<input type="text"/>	<input type="text"/>
26	<input type="checkbox"/>	<input type="text"/>	<input type="text"/>
27	<input type="checkbox"/>	<input type="text"/>	<input type="text"/>
28	<input type="checkbox"/>	<input type="text"/>	<input type="text"/>
29	<input type="checkbox"/>	<input type="text"/>	<input type="text"/>
30	<input type="checkbox"/>	<input type="text"/>	<input type="text"/>
31	<input type="checkbox"/>	<input type="text"/>	<input type="text"/>
32	<input type="checkbox"/>	<input type="text"/>	<input type="text"/>

Figure 6-7 Local User Database

The following table describes the fields in this screen.

Table 6-4 Local User Database

LABEL	DESCRIPTION
#	This is the index number of a local user account.
Active	Select this check box to enable the user profile.
User Name	Enter the user name of the user profile.
Password	Enter a password up to 31 characters long for this user profile.
Back	Click Back to go to the main wireless LAN setup screen.
Apply	Click Apply to save these settings back to the Prestige.
Cancel	Click Cancel to begin configuring this screen again.

6.8 Configuring RADIUS

Once you enable the EAP authentication, you need to specify the external sever for remote user authentication and accounting.

To set up your Prestige's RADIUS server settings, click **WIRELESS LAN, RADIUS**. The screen appears as shown.

Wireless LAN - Radius

Authentication Server

Active No

Server IP Address

Port Number

Shared Secret

Accounting Server

Active No

Server IP Address

Port Number

Shared Secret

Figure 6-8 RADIUS

The following table describes the fields in this screen.

Table 6-5 RADIUS

LABEL	DESCRIPTION
Authentication Server	
Active	Select Yes from the drop-down list box to enable user authentication through an external authentication server.
Server IP Address	Enter the IP address of the external authentication server in dotted decimal notation.
Port Number	The default port of the RADIUS server for authentication is 1812 . You need not change this value unless your network administrator instructs you to do so with additional information.
Shared Secret	Enter a password (up to 31 alphanumeric characters) as the key to be shared between the external authentication server and the access points. The key is not sent over the network. This key must be the same on the external authentication server and Prestige.
Accounting Server	
Active	Select Yes from the drop-down list box to enable user authentication through an external accounting server.
Server IP Address	Enter the IP address of the external accounting server in dotted decimal notation.
Port Number	The default port of the RADIUS server for accounting is 1813 . You need not change this value unless your network administrator instructs you to do so with additional information.
Shared Secret	Enter a password (up to 31 alphanumeric characters) as the key to be shared between the external accounting server and the access points. The key is not sent over the network. This key must be the same on the external accounting server and the Prestige.
Back	Click Back to go to the main wireless LAN setup screen.
Apply	Click Apply to save these settings back to the Prestige.
Cancel	Click Cancel to begin configuring this screen again.

Chapter 7

WAN Setup

This chapter describes how to configure WAN settings.

7.1 WAN Overview

A WAN (Wide Area Network) is an outside connection to another network or the Internet. See the *Wizard Setup* chapter for more information on the fields in the WAN screens.

7.2 ISDN

Use the ISDN interface for dial-in remote management access or a dial backup connection.

7.3 NetCAPI¹

Your ZyXEL router can take full advantage of popular European ISDN services. NetCAPI is ZyXEL's implementation of CAPI (Common ISDN Application Program Interface) capabilities over a network. It runs over DCP (Device Control Protocol) developed by RVS-COM.

NetCAPI can be used for applications such as Eurofile transfer, file transfer, G3/G4 Fax, Autoanswer host mode, telephony, etc. on Windows 95/98/NT platforms.

7.3.1 CAPI

CAPI is an interface standard that allows applications to access ISDN services. Several applications can share one or more ISDN lines. When an application wants to communicate with an ISDN terminal it sends a series of standard commands to the terminal. The CAPI standard defines the commands and allows you to use a well-defined mechanism for communications using ISDN lines.

CAPI also simplifies the development of ISDN applications through many default values that do not need to be programmed. It provides a unified interface for applications to access the different ISDN services such as data, voice, fax, telephony, etc.

7.3.2 ISDN-DCP

ISDN-DCP allows a workstation on the LAN to use services such as transmitting and receiving faxes as well as placing and receiving phone calls.

¹ NetCAPI was not available at the time of writing.

Using ISDN-DCP, the Prestige acts as a DCP server. By default, the Prestige listens for DCP messages on TCP port number 2578 (the Internet-assigned number for RVS-COM DCP). When the Prestige receives a DCP message from a DCP client i.e., a workstation, the Prestige processes the message and acts on it. Your Prestige supports all the DCP messages specified in the ISDN-DCP specification.

7.4 Metric

The metric represents the "cost of transmission". A router determines the best route for transmission by choosing a path with the lowest "cost". RIP routing uses hop count as the measurement of cost, with a minimum of "1" for directly connected networks. The number must be between "1" and "15"; a number greater than "15" means the link is down. The smaller the number, the lower the "cost".

The metric sets the priority between the Prestige's two backup routes. If these routes both have the same metric, the Prestige uses the following pre-defined priorities:

1. Traffic-redirect route (see *section 7.9*)
2. ISDN WAN-backup route, also called dial-backup (see *section 7.9*)

For example, if traffic redirect has a metric of "15" and the ISDN-backup route has a metric of "15", then the traffic-redirect acts as the primary default route. Should the DSL route fail to connect to the Internet, the Prestige first tries the traffic-redirect route. In the same manner, the Prestige uses the dial-backup route if the traffic-redirect route also fails.

If you want the dial-backup route to take first priority over the traffic-redirect route, all you need to do is set the dial-backup route's metric to "14" and the ISDN metric to "15" (or greater).

IP Policy Routing overrides the default routing behavior and takes priority over all of the routes mentioned above (see the *IP Policy Routing* chapter).

7.5 PPPoE Encapsulation

The Prestige supports PPPoE (Point-to-Point Protocol over Ethernet). PPPoE is an IETF Draft standard (RFC 2516) specifying how a personal computer (PC) interacts with a broadband modem (DSL, cable, wireless, etc.) connection. The **PPPoE** option is for a dial-up connection using PPPoE.

For the service provider, PPPoE offers an access and authentication method that works with existing access control systems (for example Radius). PPPoE provides a login and authentication method that the existing Microsoft Dial-Up Networking software can activate, and therefore requires no new learning or procedures for Windows users.

One of the benefits of PPPoE is the ability to let you access one of multiple network services, a function known as dynamic service selection. This enables the service provider to easily create and offer new IP services for individuals.

Operationally, PPPoE saves significant effort for both you and the ISP or carrier, as it requires no specific configuration of the broadband modem at the customer site.

By implementing PPPoE directly on the Prestige (rather than individual computers), the computers on the LAN do not need PPPoE software installed, since the Prestige does that part of the task. Furthermore, with NAT, all of the LANs' computers will have access.

7.6 Traffic Shaping

Traffic Shaping is an agreement between the carrier and the subscriber to regulate the average rate and fluctuations of data transmission over an ATM network. This agreement helps eliminate congestion, which is important for transmission of real time data such as audio and video connections.

Peak Cell Rate (PCR) is the maximum rate at which the sender can send cells. This parameter may be lower (but not higher) than the maximum line speed. 1 ATM cell is 53 bytes (424 bits), so a maximum speed of 832 Kbps gives a maximum PCR of 1962 cells/sec. This rate is not guaranteed because it is dependent on the line speed.

Sustained Cell Rate (SCR) is the mean cell rate of each bursty traffic source. It specifies the maximum average rate at which cells can be sent over the virtual connection. SCR may not be greater than the PCR.

Maximum Burst Size (MBS) is the maximum number of cells that can be sent at the PCR. After MBS is reached, cell rates fall below SCR until cell rate averages to the SCR again. At this time, more cells (up to the MBS) can be sent at the PCR again.

If the PCR, SCR or MBS is set to the default of "0", the system will assign a maximum value that correlates to your upstream line rate.

The following figure illustrates the relationship between PCR, SCR and MBS.

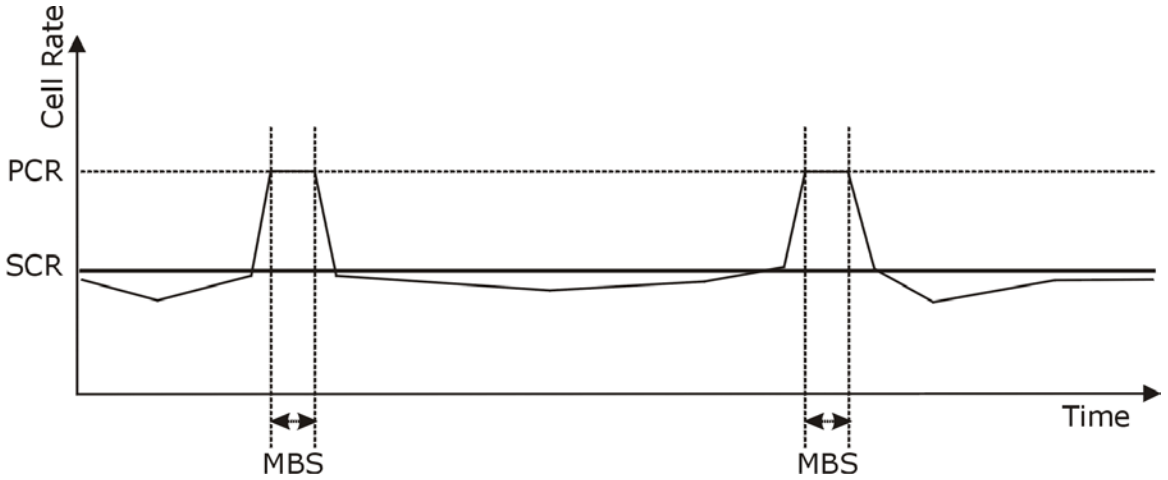

Figure 7-1 Example of Traffic Shaping

7.7 Configuring WAN Functions

To change your Prestige's WAN remote node settings, click **WAN** to access the **WAN Functions** screen.

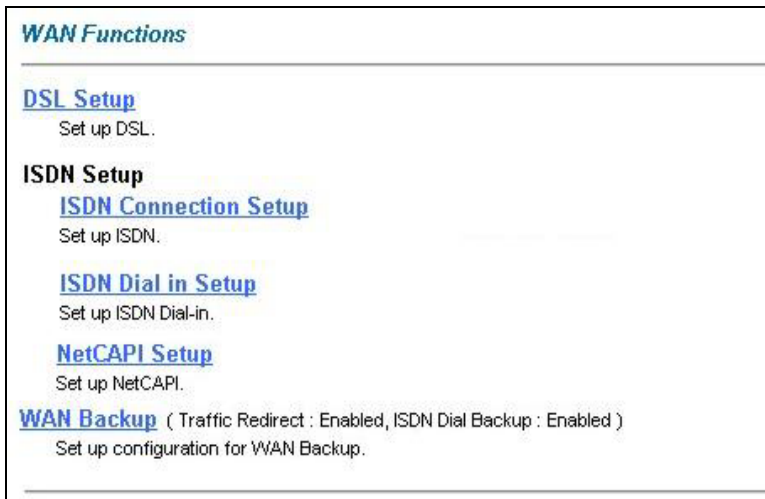

Figure 7-2 WAN Functions

The following table describes the fields in this screen.

Table 7-1 WAN Functions

LABEL	DESCRIPTION
DSL setup	To edit your DSL settings, click WAN DSL Setup . The screen differs by the encapsulation.
ISDN Connection Setup	You can use the ISDN interface as a backup in the event that the regular WAN connection is dropped.
ISDN Dial in Setup	Click ISDN Dial in Setup to edit your Prestige's Dial-in settings for remote management.
NetCAPI Setup	Click NetCAPI Setup to edit your Prestige's NetCAPI settings.
WAN Backup Traffic Redirect: ISDN Dial Backup:	Click WAN Backup to edit your Prestige's backup connection settings. These fields display either Enabled or Disabled depending on the setting of the corresponding WAN Backup configuration screen's Active fields.

7.8 Configuring WAN DSL Setup

To edit your DSL settings, click **WAN DSL Setup**. The screen differs by the encapsulation.

WAN - DSL Setup

Name	<input type="text" value="MyISP"/>
Mode	<input type="text" value="Routing"/>
Encapsulation	<input type="text" value="PPPoE"/>
Multiplex	<input type="text" value="LLC"/>
Virtual Circuit ID	
VPI	<input type="text" value="22"/>
VCI	<input type="text" value="222"/>
ATM QoS Type	<input type="text" value="CBR"/>
Cell Rate	
Peak Cell Rate	<input type="text" value="0"/> cell/sec
Sustain Cell Rate	<input type="text" value="0"/> cell/sec
Maximum Burst Size	<input type="text" value="0"/>
Login Information	
Service Name	<input type="text"/>
User Name	<input type="text" value="22"/>
Password	<input type="text" value="***"/>
IP Address	
<input checked="" type="radio"/> Obtain an IP Address Automatically	
<input type="radio"/> Static IP Address	
IP Address	<input type="text" value="0.0.0.0"/>
Connection	
<input type="radio"/> Nailed-Up Connection	
<input checked="" type="radio"/> Connect on Demand	
Max Idle Timeout	<input type="text" value="0"/> sec

Figure 7-3 WAN DSL Setup

The following table describes the fields in this screen.

Table 7-2 WAN DSL Setup

LABEL	DESCRIPTION
Name	Enter the name of your Internet Service Provider, e.g., MyISP. This information is for identification purposes only.
Mode	Select Routing (default) from the drop-down list box if your ISP allows multiple computers to share an Internet account. Otherwise select Bridge .
Encapsulation	Select the method of encapsulation used by your ISP from the drop-down list box. Choices vary depending on the mode you select in the Mode field. If you select Bridge in the Mode field, select either PPPoA or RFC 1483 . If you select Routing in the Mode field, select PPPoA , RFC 1483 , ENET ENCAP or PPPoE .
Multiplex	Select the method of multiplexing used by your ISP from the drop-down list. Choices are VC or LLC .
Virtual Circuit ID	VPI (Virtual Path Identifier) and VCI (Virtual Channel Identifier) define a virtual circuit. Refer to the appendix for more information.
VPI	The valid range for the VPI is 0 to 255. Enter the VPI assigned to you.
VCI	The valid range for the VCI is 32 to 65535 (0 to 31 is reserved for local management of ATM traffic). Enter the VCI assigned to you.
ATM QoS Type	Select CBR (Continuous Bit Rate) to specify fixed (always-on) bandwidth for voice or data traffic. Select UBR (Unspecified Bit Rate) for applications that are non-time sensitive, such as e-mail. Select VBR (Variable Bit Rate) for bursty traffic and bandwidth sharing with other applications.
Cell Rate	Cell rate configuration often helps eliminate traffic congestion that slows transmission of real time data such as audio and video connections.
Peak Cell Rate	Divide the DSL line rate (bps) by 424 (the size of an ATM cell) to find the Peak Cell Rate (PCR). This is the maximum rate at which the sender can send cells. Type the PCR here.

Table 7-2 WAN DSL Setup

LABEL	DESCRIPTION
Sustain Cell Rate	The Sustain Cell Rate (SCR) sets the average cell rate (long-term) that can be transmitted. Type the SCR, which must be less than the PCR. Note that system default is 0 cells/sec.
Maximum Burst Size	Maximum Burst Size (MBS) refers to the maximum number of cells that can be sent at the peak rate. Type the MBS, which is less than 65535.
Login Information	(PPPoA and PPPoE encapsulation only)
Service Name	(PPPoE only) Type the name of your PPPoE service here.
User Name	Enter the user name exactly as your ISP assigned. If assigned a name in the form <u>user@domain</u> where domain identifies a service name, then enter both components exactly as given.
Password	Enter the password associated with the user name above.
IP Address	This option is available if you select Routing in the Mode field. A static IP address is a fixed IP that your ISP gives you. A dynamic IP address is not fixed; the ISP assigns you a different one each time you connect to the Internet. The Single User Account feature can be used with either a dynamic or static IP address. Select Obtain an IP Address Automatically if you have a dynamic IP address; otherwise select Static IP Address and type your ISP assigned IP address in the IP Address field below.
Connection (PPPoA and PPPoE encapsulation only)	The schedule rule(s) in SMT menu 26 have priority over your Connection settings.
Nailed-Up Connection	Select Nailed-Up Connection when you want your connection up all the time. The Prestige will try to bring up the connection automatically if it is disconnected.
Connect on Demand	Select Connect on Demand when you don't want the connection up all the time and specify an idle time-out in the Max Idle Timeout field.
Max Idle Timeout	Specify an idle time-out in the Max Idle Timeout field when you select Connect on Demand . The default setting is 0, which means the Internet session will not timeout.

Table 7-2 WAN DSL Setup

LABEL	DESCRIPTION
Subnet Mask (ENET ENCAP encapsulation only)	Enter a subnet mask in dotted decimal notation. Refer to the <i>Subnetting</i> appendix in the to calculate a subnet mask If you are implementing subnetting.
ENET ENCAP Gateway (ENET ENCAP encapsulation only)	You must specify a gateway IP address (supplied by your ISP) when you select ENET ENCAP in the Encapsulation field
Back	Click Back to return to the previous screen.
Apply	Click Apply to save the changes.
Cancel	Click Cancel to begin configuring this screen afresh.

7.9 ISDN Connection Setup

To edit your Prestige's advanced WAN backup settings, click **WAN, ISDN Connection Setup**. The screen appears as shown.

The screenshot shows a web-based configuration interface for ISDN connection settings. The page title is "WAN - ISDN Connection Setup". It is organized into several sections:

- Basic**: Includes input fields for "ISDN Phone Number" and "Outside Line Prefix".
- Outgoing**: Includes input fields for "User Name", "Password", "Primary Phone Number", and "Secondary Phone Number".
- IP Address**: Features two radio buttons: "Obtain an IP Address Automatically" (unselected) and "Static IP Address" (selected). Below is an input field for "IP Address" containing "0.0.0.0".
- Network Address Translation**: A dropdown menu currently set to "SUA Only".
- Dial out Channel Setting**: A dropdown menu currently set to "Off".
- Connection**: Features two radio buttons: "Nailed-Up Connection" (unselected) and "Connect on Demand" (selected). Below is an input field for "Max Idle Timeout" set to "100" with the unit "sec".
- Budget**: Includes two input fields: "Allocated Budget" set to "0" with the unit "min", and "Period" set to "0" with the unit "hr".

At the bottom of the form are three buttons: "Back", "Apply", and "Cancel".

Figure 7-4 ISDN Connection Setup

The following table describes the fields in this screen.

Table 7-3 ISDN Connection Setup

LABEL	DESCRIPTION
Basic	
ISDN Phone Number	The number of your ISDN line.
Outside Line Prefix	A PABX (Private Automatic Branch eXchange) generally requires you to dial a number (a single digit in most cases) when you need an outside line. If your router is connected to a PABX enter this number in Outside Line Prefix , otherwise leave it blank.
Outgoing	
Username	Enter the login name given to you by your ISP.
Password	Enter the password associated with the login name above.
Primary Phone Number Secondary Phone Number	Enter the primary and the secondary phone numbers to connect to the ISP.
IP Address	
Obtain and IP Address Automatically	Some implementations, especially the UNIX derivatives, require the WAN link to have a separate IP network number from the LAN and each end must have a unique address within the WAN network number. If this is the case, select this option.
Static IP Address	Select this option to assign a static IP address to your router's WAN port.
IP Address	Enter the IP address in dotted decimal notation (i.e. 0.0.0.0).
Network Address Translation	Choose from None , Full Feature or SUA Only . When you select Full Feature you must configure at least one address mapping set. See the chapter on NAT for a full discussion of this new feature.
Dial out Channel Setting	
Multilink	The router uses the PPP Multilink Protocol (PPP/MP) to bundle multiple links in a single connection to boost the effective throughput between two nodes. This option is only available if the transfer type is 64K. Options for this field are: Off , BOD and Always .
Connection	

Table 7-3 ISDN Connection Setup

LABEL	DESCRIPTION
Nailed-Up Connection	Select Nailed-Up Connection when you want your connection up all the time. The Prestige will try to bring up the connection automatically if it is disconnected.
Connect on Demand	Select Connect on Demand when you don't want the connection up all the time and specify an idle time-out in the Max Idle Timeout field.
Max Idle Timeout	Specify an idle time-out in the Max Idle Timeout field when you select Connect on Demand . The default setting is 0, which means the Internet session will not timeout.
Budget	
Allocate Budget	Type the amount of time (in minutes) that the dial backup connection can be used during the time configured in the Period field. Set an amount that is less than the time period configured in the Period field. If you set the Allocated Budget to 0, you will not be able to use the dial backup connection.
Period	Type the time period (in hours) for how often the budget should be reset. For example, to allow calls to this remote node for a maximum of 10 minutes every hour, set the Allocated Budget to 10 (minutes) and the Period to 1 (hour). If you set the Period to 0, there is no budget control and the Prestige uses the Connection settings.
Back	Click Back to return to the previous screen.
Apply	Click Apply to save the changes and return to the previous screen.
Cancel	Click Cancel to begin configuring this screen afresh.

7.10 ISDN Dial In Setup

To edit your Prestige's Dial In Setup, click **WAN ISDN Dial In Setup**. The screen appears as shown.

WAN - ISDN Dial in Setup

Incoming

Rem Login Name

Rem Password

IP Address

Rem IP Address

Rem Subnet Mask

Wan IP Address

Network Address Translation

▼

Dial in Channel Setting

Multilink ▼

Budget

Allocated Budget min

Period hr

Figure 7-5 ISDN Dial In Setup

The following table describes the fields in this screen.

Table 7-4 ISDN Dial In Setup

LABEL	DESCRIPTION
Incoming	
Rem Login Name	Type the remote node login name that the remote node must use to access the Prestige.
Rem Password	Type the remote node password corresponding to the remote node login name.
IP Address	
Rem IP Address	Type the IP address of the remote node in dotted decimal notation.
Rem Subnet Mask	Type the subnet mask assigned to the remote node.
WAN IP Address	Type the IP address assigned to the WAN port of your Prestige
Network Address Translation	Choose from None , Full Feature or SUA Only . When you select Full Feature you must configure at least one address mapping set. See the chapter on NAT for a full discussion of this new feature.
Dial in Channel Setting	
Multilink	The router uses the PPP Multilink Protocol (PPP/MP) to bundle multiple links in a single connection to boost the effective throughput between two nodes. This option is only available if the transfer type is 64K. Options for this field are: Off , BOD and Always .
Budget	
Allocate Budget	Type the amount of time (in minutes) that the dial backup connection can be used during the time configured in the Period field. Set an amount that is less than the time period configured in the Period field. If you set the Allocated Budget to 0, you will not be able to use the dial backup connection.
Period	Type the time period (in hours) for how often the budget should be reset. For example, to allow calls to this remote node for a maximum of 10 minutes every hour, set the Allocated Budget to 10 (minutes) and the Period to 1 (hour). If you set the Period to 0, there is no budget control and the Prestige uses the Connection settings.
Back	Click Back to return to the previous screen.
OK	Click OK to return to the previous screen, then click OK to return to the next previous screen and click Apply to save the changes.
Cancel	Click Cancel to begin configuring this screen afresh.

7.11 Configuring NetCAPI

To edit your Prestige's NetCAPI settings, click **WAN, NetCAPI Setup**. The screen appears as shown.

WAN - NetCAPI

Active

Max Number of Registered Users:

Incoming Data Call Number Matching:

Start IP	End IP	Operation
<input type="text" value="0.0.0.0"/>	<input type="text" value="0.0.0.0"/>	<input type="text" value="None"/>
<input type="text" value="0.0.0.0"/>	<input type="text" value="0.0.0.0"/>	<input type="text" value="None"/>
<input type="text" value="0.0.0.0"/>	<input type="text" value="0.0.0.0"/>	<input type="text" value="None"/>
<input type="text" value="0.0.0.0"/>	<input type="text" value="0.0.0.0"/>	<input type="text" value="None"/>
<input type="text" value="0.0.0.0"/>	<input type="text" value="0.0.0.0"/>	<input type="text" value="None"/>
<input type="text" value="0.0.0.0"/>	<input type="text" value="0.0.0.0"/>	<input type="text" value="None"/>
<input type="text" value="0.0.0.0"/>	<input type="text" value="0.0.0.0"/>	<input type="text" value="None"/>
<input type="text" value="0.0.0.0"/>	<input type="text" value="0.0.0.0"/>	<input type="text" value="None"/>
Default		<input type="text" value="None"/>

Figure 7-6 Configuring NetCAPI

The following table describes the fields in this screen.

Table 7-5 Configuring NetCAPi

LABEL	DESCRIPTION
Active	Select this check box to enable NetCAPi.
Max Number of Registered Users	When you want to use NetCAPi to place outgoing calls or to listen to incoming calls, you must start RVSCOM on your computer, and RVSCOM registers itself to the Prestige. Enter the maximum number of clients (no more than 5) for which you want the Prestige to allow connections at the same time.
Incoming Data Call Number Matching	This field determines how incoming calls are routed. Select NetCAPi if you want to direct all incoming data calls to NetCAPi. Select Subscriber Number (MSN) if you want to direct all incoming call to the Prestige only when the incoming phone number matches the ISDN DATA number. If the incoming phone number does not match the ISDN DATA number, then the call will be routed to NetCAPi. Select Called Party Subaddress if you want to direct all incoming calls to the Prestige only when the incoming call matches the subaddress of ISDN DATA. If the incoming call does not match the subaddress of ISDN DATA, then the call will be routed to NetCAPi.
Start IP	Refers to the first IP address of a group of NetCAPi clients. Each group contains contiguous IP addresses
End IP	Refers to the last IP address in a NetCAPi client group.
Operation	Select Incoming if you wish to grant incoming calls permission. Select Outgoing if you wish to grant outgoing calls permission. Select Both if you wish to grant both incoming calls and outgoing calls permissions. Select None if you wish to deny all calls.
Back	Click Back to return to the previous screen.
OK	Click OK to return to the previous screen, then click OK to return to the next previous screen and click Apply to save the changes.
Cancel	Click Cancel to begin configuring this screen afresh.

7.11.1 Configuring the Prestige as a NetCAPi Server

This section describes how to configure your Prestige to be a NetCAPi server.

By default, NetCAPi is enabled on your Prestige. When NetCAPi is enabled, the Prestige listens for incoming DCP messages from the workstations. By default, the Prestige listens for DCP messages on TCP port 2578.

The following figure illustrates the configuration used in this example.

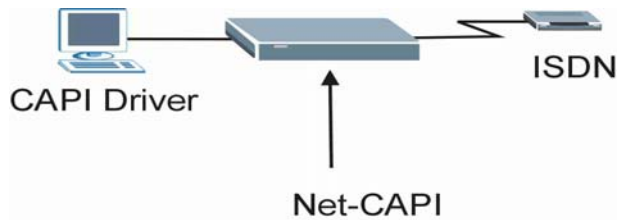

Figure 7-7 Configuration Example

Before entering any configurations, you must install the CAPI driver (RVS-CE) and communication program such as RVS-COM Lite on your computer.

7.11.2 RVS-COM

RVS-COM includes an ISDN CAPI driver with its communication program. RVS-CE (Core Engine) is an ISDN-CAPI 2.0 driver for Windows 95/98/NT that can be used by different ISDN communication programs (such as AVM Fritz or RVS-COM) to access the ISDN on the Prestige.

NetCAPI can carry out CAPI applications only if the CAPI driver is installed on your workstation. In addition to the CAPI driver, you will need a communication software program such as RVS-COM Lite, Fritz etc., for users to access CAPI.

The ISDN router is a shared device and can be used by several different client workstations at the same time: e.g. one workstation sending a fax, another workstation doing a file transfer. RVS-COM has to be installed on each client workstation in order to share the ISDN lines.

7.11.3 Example of Installing a CAPI driver and Communication Software

Please uninstall previous versions of "RVS-CAPI" and "RVS-COM lite" before you install the new versions. You may use the Windows "START | Settings | Control Panel | Add/Remove Programs" to uninstall RVS-CAPI and RVS-COM.]

To install the CAPI driver and the communication software, enter one of the license keys of your RVS-COM Lite CD-ROM and follow the instructions on the configuration wizard. When you install RVS-Lite, RVS-COM AUTOMATICALLY installs CAPI driver before installing RVS-Lite.

If you did not install RVS-Lite and want to use other programs such as AVM Fritz to access the ISDN router, you must first install the CAPI driver - RVS-CE using the English version installation wizard (in \DISKs\CEPE\DISK1\) and start the SETUP.EXE.

7.12 WAN Backup

Should the DSL connection fail, traffic redirect can transfer data to a backup gateway. You can also use the ISDN port for a dial-up connection should the DSL connection fail. To set up the ISDN port for backup usage, first make sure you have set up the port connection (see the *Compact Guide*).

7.13 Traffic Redirect on the LAN

Traffic redirect forwards LAN traffic to a backup gateway when the Prestige cannot connect to the Internet. An example is shown in the figure below.

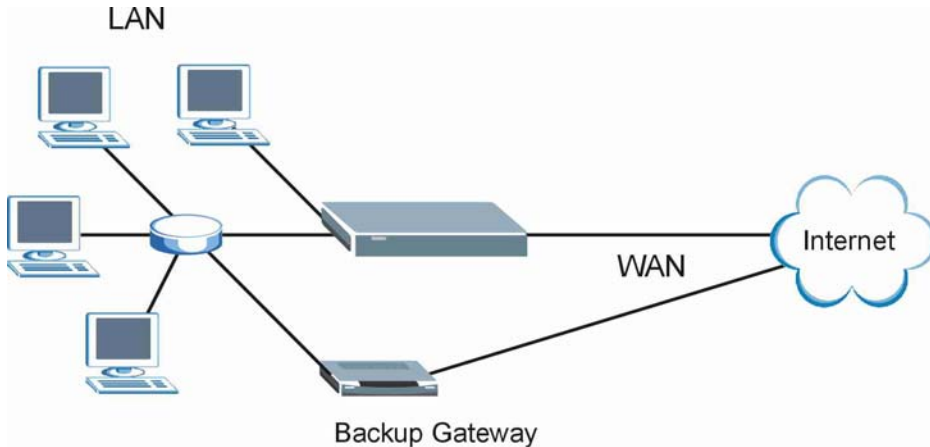

Figure 7-8 Traffic Redirect Setup Example

7.14 Traffic Redirect on the WAN

Traffic redirect forwards WAN traffic to a backup gateway when the Prestige cannot connect to the Internet through its normal gateway. Connect the backup gateway on the WAN so that the Prestige still provides firewall protection.

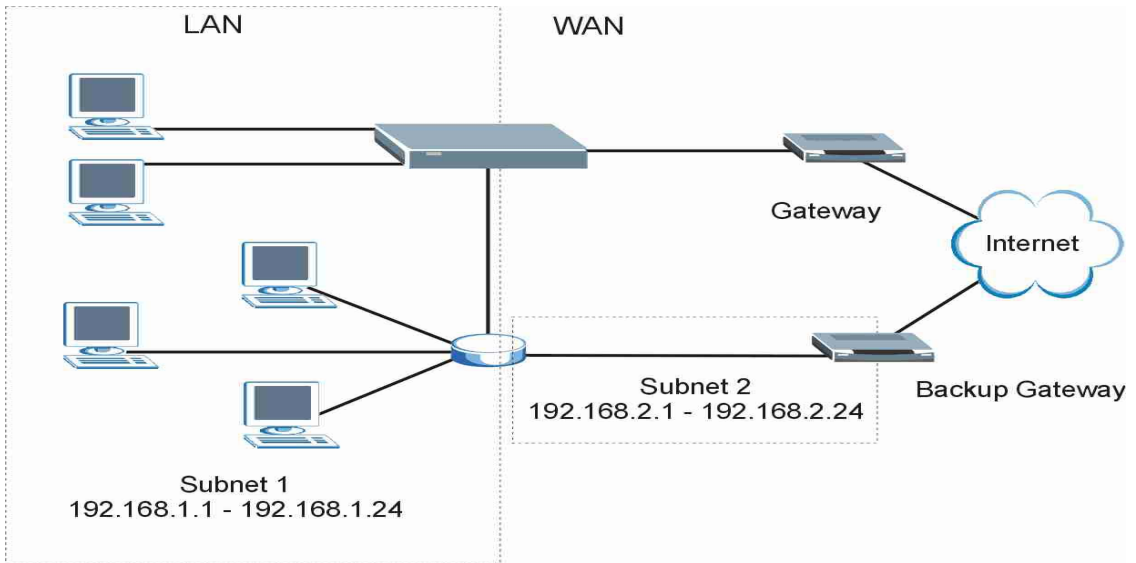

Figure 7-9 Traffic Redirect WAN Setup

The following network topology allows you to avoid triangle route security issues when the backup gateway is connected to the LAN or DMZ. Use IP alias to configure the LAN into two or three logical networks with the Prestige itself as the gateway for each LAN network. Put the protected LAN in one subnet (Subnet 1 in the following figure) and the backup gateway in another subnet (Subnet 2). Configure a LAN to LAN/Prestige firewall rule that forwards packets from the protected LAN (Subnet 1) to the backup gateway (Subnet 2).

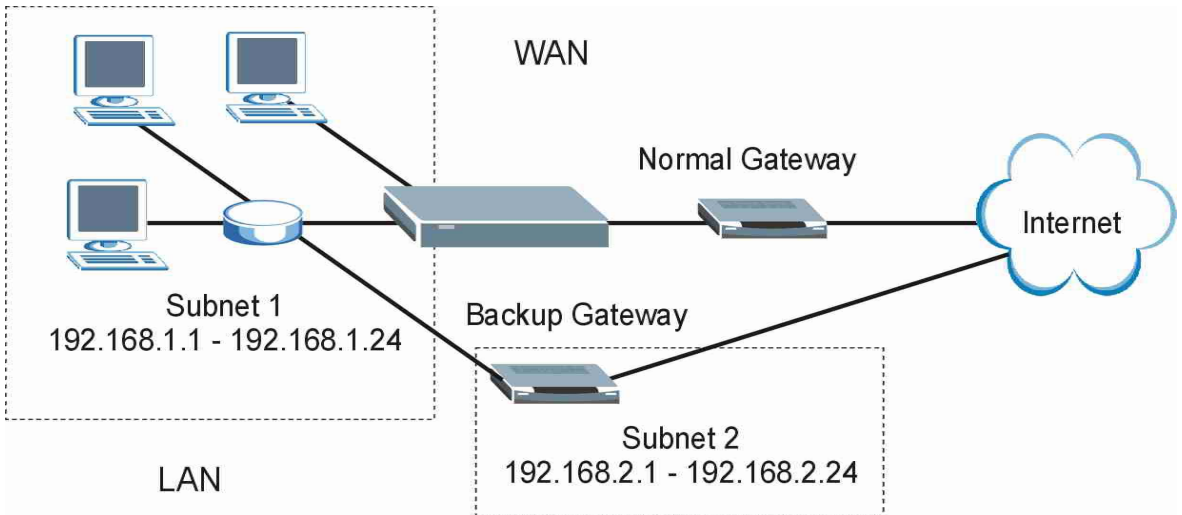

Figure 7-10 Traffic Redirect LAN Setup

7.15 Configuring WAN Backup

To change your Prestige's WAN backup settings, click **WAN**, then **WAN Backup**. The screen appears as shown.

WAN - WAN Backup Setup

Backup Type:

Check WAN IP Address1:

Check WAN IP Address2:

Check WAN IP Address3:

Fail Tolerance:

Recovery Interval: sec

Timeout: sec

Traffic Redirect

Active

Metric:

Backup Gateway:

ISDN Dial Backup

Active

Metric:

Figure 7-11 WAN Backup Setup

The following table describes the fields in this screen.

Table 7-6 WAN Backup Setup

LABEL	DESCRIPTION
Backup Type	Select the method that the Prestige uses to check the DSL connection. Select DSL Link to have the Prestige check the DSL connection's physical layer. Select ICMP to have the Prestige periodically ping the IP addresses configured in the Check WAN IP Address fields.
Check WAN IP Address1-3	Configure this field to test your Prestige's WAN accessibility. Type the IP address of a reliable nearby computer (for example, your ISP's DNS server address). When using a WAN backup connection, the Prestige periodically pings the addresses configured here and uses the other WAN backup connection (if configured) if there is no response.
Fail Tolerance	Type the number of times (2 recommended) that your Prestige may ping the IP addresses configured in the Check WAN IP Address field without getting a response before switching to a WAN backup connection (or a different WAN backup connection).
Recovery Interval	When the Prestige is using a lower priority connection (usually a WAN backup connection), it periodically checks to whether or not it can use a higher priority connection. Type the number of seconds (30 recommended) for the Prestige to wait between checks. Allow more time if your destination IP address handles lots of traffic.
Timeout	Type the number of seconds (3 recommended) for your Prestige to wait for a ping response from one of the IP addresses in the Check WAN IP Address field before timing out the request. The WAN connection is considered "down" after the Prestige times out the number of times specified in the Fail Tolerance field. Use a higher value in this field if your network is busy or congested.
Traffic Redirect	
Active	Select this check box to have the Prestige use traffic redirect if the normal WAN connection goes down. Enabled displays on the preceding WAN Functions screen (see <i>Figure 7-2</i>).
Metric	This field sets this route's priority between the two backup routes the Prestige uses. The metric represents the "cost of transmission". A router determines the best route for transmission by choosing a path with the lowest "cost". RIP routing uses hop count as the measurement of cost, with a minimum of "1" for directly connected networks. The number must be between "1" and "15"; a number greater than "15" means the link is down. The smaller the number, the lower the "cost".

Table 7-6 WAN Backup Setup

LABEL	DESCRIPTION
Backup Gateway	Type the IP address of your backup gateway in dotted decimal notation. The Prestige automatically forwards traffic to this IP address if the Prestige's Internet connection terminates.
ISDN Dial Backup	
Active	Select this check box to turn on dial backup. Enabled displays on the preceding WAN Functions screen (see <i>Figure 7-2</i>).
Metric	<p>This field sets this route's priority between the two backup routes the Prestige uses.</p> <p>The metric represents the "cost of transmission". A router determines the best route for transmission by choosing a path with the lowest "cost". RIP routing uses hop count as the measurement of cost, with a minimum of "1" for directly connected networks. The number must be between "1" and "15"; a number greater than "15" means the link is down. The smaller the number, the lower the "cost".</p>
Back	Click Back to return to the previous screen.
Apply	Click Apply to save the changes.
Cancel	Click Cancel to begin configuring this screen afresh.

Part III:

NAT, Dynamic DNS and Time Zone

This part covers NAT (Network Address Translation), dynamic DNS (Domain Name Server) and Time Zone setup.

Chapter 8

Network Address Translation (NAT)

Screens

This chapter discusses how to configure NAT on the Prestige.

8.1 NAT Overview

NAT (Network Address Translation - NAT, RFC 1631) is the translation of the IP address of a host in a packet, for example, the source address of an outgoing packet, used within one network to a different IP address known within another network.

8.1.1 NAT Definitions

Inside/outside denotes where a host is located relative to the Prestige, for example, the computers of your subscribers are the inside hosts, while the web servers on the Internet are the outside hosts.

Global/local denotes the IP address of a host in a packet as the packet traverses a router, for example, the local address refers to the IP address of a host when the packet is in the local network, while the global address refers to the IP address of the host when the same packet is traveling in the WAN side.

Note that inside/outside refers to the location of a host, while global/local refers to the IP address of a host used in a packet. Thus, an inside local address (ILA) is the IP address of an inside host in a packet when the packet is still in the local network, while an inside global address (IGA) is the IP address of the same inside host when the packet is on the WAN side. The following table summarizes this information.

Table 8-1 NAT Definitions

ITEM	DESCRIPTION
Inside	This refers to the host on the LAN.
Outside	This refers to the host on the WAN.
Local	This refers to the packet address (source or destination) as the packet travels on the LAN.
Global	This refers to the packet address (source or destination) as the packet travels on the WAN.

NAT never changes the IP address (either local or global) of an outside host.

8.1.2 What NAT Does

In the simplest form, NAT changes the source IP address in a packet received from a subscriber (the inside local address) to another (the inside global address) before forwarding the packet to the WAN side. When the response comes back, NAT translates the destination address (the inside global address) back to the inside local address before forwarding it to the original inside host. Note that the IP address (either local or global) of an outside host is never changed.

The global IP addresses for the inside hosts can be either static or dynamically assigned by the ISP. In addition, you can designate servers, for example, a web server and a telnet server, on your local network and make them accessible to the outside world. Although you can make designated servers on the LAN accessible to the outside world, it is strongly recommended that you attach those servers to the DMZ port instead. If you do not define any servers (for Many-to-One and Many-to-Many Overload mapping – see *Table 8-2*), NAT offers the additional benefit of firewall protection. With no servers defined, your Prestige filters out all incoming inquiries, thus preventing intruders from probing your network. For more information on IP address translation, refer to *RFC 1631, The IP Network Address Translator (NAT)*.

8.1.3 How NAT Works

Each packet has two addresses – a source address and a destination address. For outgoing packets, the ILA (Inside Local Address) is the source address on the LAN, and the IGA (Inside Global Address) is the source address on the WAN. For incoming packets, the ILA is the destination address on the LAN, and the IGA is the destination address on the WAN. NAT maps private (local) IP addresses to globally unique ones required for communication with hosts on other networks. It replaces the original IP source address (and TCP or UDP source port numbers for Many-to-One and Many-to-Many Overload NAT mapping) in each packet and then forwards it to the Internet. The Prestige keeps track of the original addresses and port numbers so incoming reply packets can have their original values restored. The following figure illustrates this.

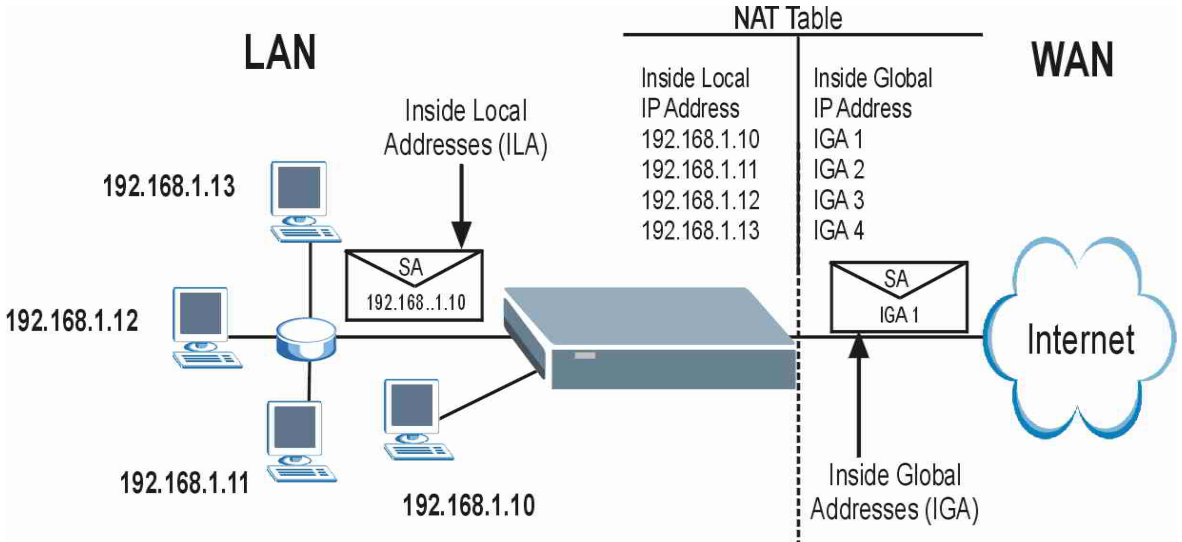

Figure 8-1 How NAT Works

8.1.4 NAT Application

The following figure illustrates a possible NAT application, where three inside LANs (logical LANs using IP Alias) behind the Prestige can communicate with three distinct WAN networks. More examples follow at the end of this chapter.

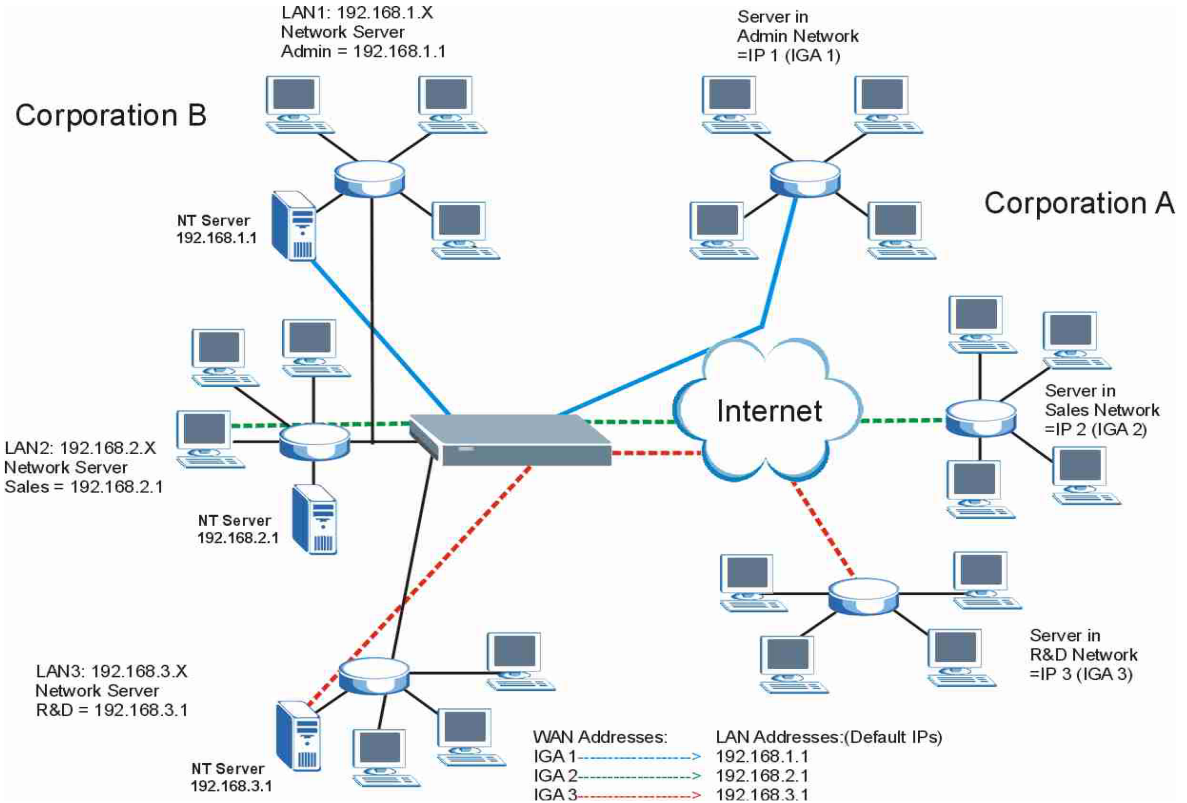

Figure 8-2 NAT Application With IP Alias

8.1.5 NAT Mapping Types

NAT supports five types of IP/port mapping. They are:

1. **One to One:** In One-to-One mode, the Prestige maps one local IP address to one global IP address.
2. **Many to One:** In Many-to-One mode, the Prestige maps multiple local IP addresses to one global IP address. This is equivalent to SUA (for instance, PAT, port address translation), ZyXEL's Single User Account feature that previous ZyXEL routers supported (the **SUA Only** option in today's routers).
3. **Many to Many Overload:** In Many-to-Many Overload mode, the Prestige maps the multiple local IP addresses to shared global IP addresses.
4. **Many-to-Many No Overload:** In Many-to-Many No Overload mode, the Prestige maps each local IP address to a unique global IP address.

5. **Server:** This type allows you to specify inside servers of different services behind the NAT to be accessible to the outside world although, it is highly recommended that you use the DMZ port for these servers instead.

Port numbers do not change for One-to-One and Many-to-Many No Overload NAT mapping types.

The following table summarizes these types.

Table 8-2 NAT Mapping Types

TYPE	IP MAPPING	SMT ABBREVIATION
One-to-One	ILA1↔ IGA1	1:1
Many-to-One (SUA/PAT)	ILA1↔ IGA1 ILA2↔ IGA1 ...	M:1
Many-to-Many Overload	ILA1↔ IGA1 ILA2↔ IGA2 ILA3↔ IGA1 ILA4↔ IGA2 ...	M:M Ov
Many-to-Many No Overload	ILA1↔ IGA1 ILA2↔ IGA2 ILA3↔ IGA3 ...	M:M No OV
Server	Server 1 IP↔ IGA1 Server 2 IP↔ IGA1 Server 3 IP↔ IGA1	Server

8.2 SUA (Single User Account) Versus NAT

SUA (Single User Account) is a ZyNOS implementation of a subset of NAT that supports two types of mapping, **Many-to-One** and **Server**. The Prestige also supports **Full Feature** NAT to map multiple global IP addresses to multiple private LAN IP addresses of clients or servers using mapping types as outlined in *Table 8-2*.

- 1. Choose SUA Only if you have just one public WAN IP address for your Prestige.**
- 2. Choose Full Feature if you have multiple public WAN IP addresses for your Prestige.**

8.3 SUA Server

A SUA server set is a list of inside (behind NAT on the LAN) servers, for example, web or FTP, that you can make visible to the outside world even though SUA makes your whole inside network appear as a single computer to the outside world.

You may enter a single port number or a range of port numbers to be forwarded, and the local IP address of the desired server. The port number identifies a service; for example, web service is on port 80 and FTP on port 21. In some cases, such as for unknown services or where one server can support more than one service (for example both FTP and web service), it might be better to specify a range of port numbers. You can allocate a server IP address that corresponds to a port or a range of ports.

Many residential broadband ISP accounts do not allow you to run any server processes (such as a Web or FTP server) from your location. Your ISP may periodically check for servers and may suspend your account if it discovers any active services at your location. If you are unsure, refer to your ISP.

Default Server IP Address

In addition to the servers for specified services, NAT supports a default server IP address. A default server receives packets from ports that are not specified in this screen.

If you do not assign a Default Server IP Address, the Prestige discards all packets received for ports that are not specified here or in the remote management setup.

8.3.1 Port Forwarding: Services and Port Numbers

A NAT server set is a list of inside (behind NAT on the LAN) servers, for example, web or FTP, that you can make accessible to the outside world even though NAT makes your whole inside network appear as a single machine to the outside world. The Prestige 100 provides the additional safety of a DMZ port for connecting your publicly accessible servers. This makes the LAN more secure by physically separating it from your public servers.

Use the **SUA Server** page to forward incoming service requests to the server(s) on your local network. You may enter a single port number or a range of port numbers to be forwarded, and the local IP address of the desired server. The port number identifies a service; for example, web service is on port 80 and FTP on port 21. In some cases, such as for unknown services or where one server can support more than one service (for example both FTP and web service), it might be better to specify a range of port numbers.

In addition to the servers for specified services, NAT supports a default server. A service request that does not have a server explicitly designated for it is forwarded to the default server. If the default is not defined, the service request is simply discarded.

Many residential broadband ISP accounts do not allow you to run any server processes (such as a Web or FTP server) from your location. Your ISP may periodically check for servers and may suspend your account if it discovers any active services at your location. If you are unsure, refer to your ISP.

The most often used port numbers are shown in the following table. Please refer to RFC 1700 for further information about port numbers.

Table 8-3 Services and Port Numbers

SERVICES	PORT NUMBER
ECHO	7
FTP (File Transfer Protocol)	21
SMTP (Simple Mail Transfer Protocol)	25
DNS (Domain Name System)	53
Finger	79
HTTP (Hyper Text Transfer protocol or WWW, Web)	80
POP3 (Post Office Protocol)	110
NNTP (Network News Transport Protocol)	119
SNMP (Simple Network Management Protocol)	161
SNMP trap	162
PPTP (Point-to-Point Tunneling Protocol)	1723

8.3.2 Configuring Servers Behind SUA (Example)

Let's say you want to assign ports 22-25 to one server, port 80 to another and assign a default server IP address of 192.168.1.35 as shown in the next figure.

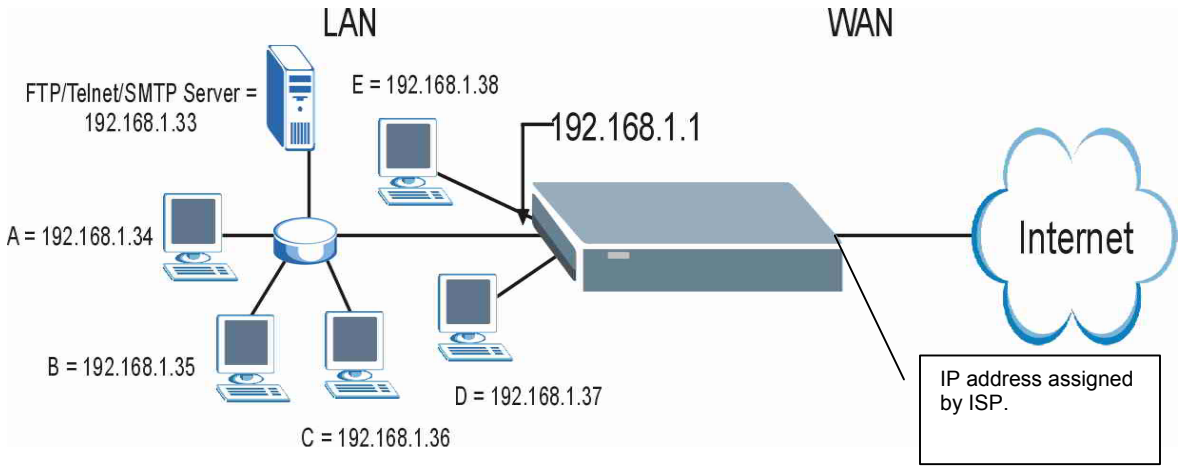

Figure 8-3 Multiple Servers Behind NAT Example

8.4 Selecting the NAT Mode

You must create a firewall rule in addition to setting up SUA/NAT, to allow traffic from the WAN to be forwarded through the Prestige.

Click **NAT** to open the following screen.

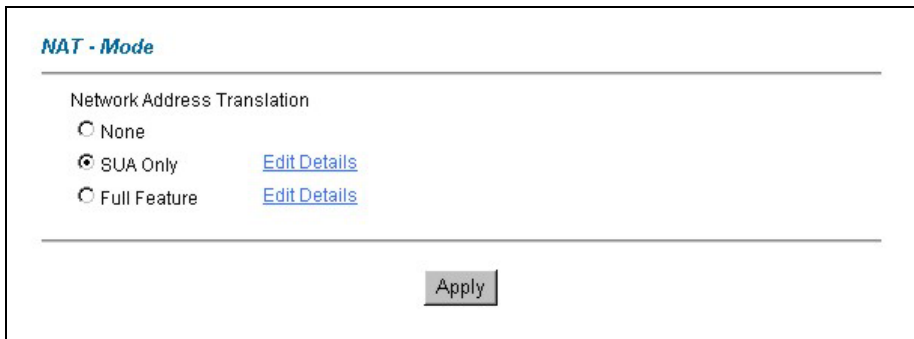

Figure 8-4 NAT Mode

Table 8-4 NAT Mode

LABEL	DESCRIPTION
None	Select this radio button to disable NAT.
SUA Only	Select this radio button if you have just one public WAN IP address for your Prestige. The Prestige uses Address Mapping Set 1 in the NAT - Edit SUA NAT Server Set screen.
Edit Details	Click this link to go to the NAT - Edit SUA NAT Server Set screen.
Full Feature	Select this radio button if you have multiple public WAN IP addresses for your Prestige.
Edit Details	Click this link to go to the NAT - Address Mapping Rules screen.
Apply	Click Apply to save your configuration.

8.5 Configuring SUA Server

If you do not assign a Default Server IP Address, then all packets received for ports not specified in this screen will be discarded.

Click **NAT**, Select **SUA Only** and click **Edit Details** to open the following screen.

Refer to the firewall chapters for port numbers commonly used for particular services.

NAT - Edit SUA/NAT Server Set

	Start Port No.	End Port No.	IP Address
1	All ports	All ports	0.0.0.0
2	0	0	0.0.0.0
3	0	0	0.0.0.0
4	0	0	0.0.0.0
5	0	0	0.0.0.0
6	0	0	0.0.0.0
7	0	0	0.0.0.0
8	0	0	0.0.0.0
9	0	0	0.0.0.0
10	0	0	0.0.0.0
11	0	0	0.0.0.0
12	0	0	0.0.0.0

Save Cancel

Figure 8-5 Edit SUA/NAT Server Set

The following table describes the fields in this screen.

Table 8-5 Edit SUA/NAT Server Set

LABEL	DESCRIPTION
Start Port No.	Enter a port number in this field. To forward only one port, enter the port number again in the End Port No. field. To forward a series of ports, enter the start port number here and the end port number in the End Port No. field.
End Port No.	Enter a port number in this field. To forward only one port, enter the port number again in the Start Port No. field above and then enter it again in this field. To forward a series of ports, enter the last port number in a series that begins with the port number in the Start Port No. field above.

Table 8-5 Edit SUA/NAT Server Set

LABEL	DESCRIPTION
Server IP Address	Enter your server IP address in this field.
Save	Click Save to save your changes back to the Prestige.
Cancel	Click Cancel to return to the previous configuration.

8.6 Configuring Address Mapping

Ordering your rules is important because the Prestige applies the rules in the order that you specify. When a rule matches the current packet, the Prestige takes the corresponding action and the remaining rules are ignored. If there are any empty rules before your new configured rule, your configured rule will be pushed up by that number of empty rules. For example, if you have already configured rules 1 to 6 in your current set and now you configure rule number 9. In the set summary screen, the new rule will be rule 7, not 9. Now if you delete rule 4, rules 5 to 7 will be pushed up by 1 rule, so old rules 5, 6 and 7 become new rules 4, 5 and 6.

To change your Prestige's address mapping settings, click **NAT**, Select **Full Feature** and click **Edit Details** to open the following screen.

NAT - Address Mapping Rules

	Local Start IP	Local End IP	Global Start IP	Global End IP	Type
Rule 1	-
Rule 2	-
Rule 3	-
Rule 4	-
Rule 5	-
Rule 6	-
Rule 7	-
Rule 8	-
Rule 9	-
Rule 10	-

Back

Figure 8-6 Address Mapping Rules

The following table describes the fields in this screen.

Table 8-6 Address Mapping Rules

LABEL	DESCRIPTION
Local Start IP	This is the starting Inside Local IP Address (ILA). Local IP addresses are N/A for Server port mapping.
Local End IP	This is the end Inside Local IP Address (ILA). If your rule is for all local IP addresses, then enter 0.0.0.0 as the Local Start IP address and 255.255.255.255 as the Local End IP address. This field is N/A for One-to-one and Server mapping types.
Global Start IP	This is the starting Inside Global IP Address (IGA). Enter 0.0.0.0 here if you have a dynamic IP address from your ISP. You can only do this for Many-to-One and Server mapping types.
Global End IP	This is the ending Inside Global IP Address (IGA). This field is N/A for One-to-one , Many-to-One and Server mapping types.
Type	<p>1-1: One-to-one mode maps one local IP address to one global IP address. Note that port numbers do not change for the One-to-one NAT mapping type.</p> <p>M-1: Many-to-One mode maps multiple local IP addresses to one global IP address. This is equivalent to SUA (i.e., PAT, port address translation), ZyXEL's Single User Account feature that previous ZyXEL routers supported only.</p> <p>M-M Ov (Overload): Many-to-Many Overload mode maps multiple local IP addresses to shared global IP addresses.</p> <p>MM No (No Overload): Many-to-Many No Overload mode maps each local IP address to unique global IP addresses.</p> <p>Server: This type allows you to specify inside servers of different services behind the NAT to be accessible to the outside world.</p>
Back	Click Back to return to the NAT Mode screen.

8.7 Editing an Address Mapping Rule

To edit an address mapping rule, click the rule's link in the **NAT Address Mapping Rules** screen to display the screen shown next.

NAT - Edit Address Mapping Rule 1

Type:

Local Start IP:

Local End IP:

Global Start IP:

Global End IP:

Server Mapping Set: [Edit Details](#)

Figure 8-7 Address Mapping Rule Edit

The following table describes the fields in this screen.

Table 8-7 Address Mapping Rule Edit

LABEL	DESCRIPTION
Type	Choose the port mapping type from one of the following. <ol style="list-style-type: none"> One-to-One: One-to-One mode maps one local IP address to one global IP address. Note that port numbers do not change for One-to-one NAT mapping type. Many-to-One: Many-to-One mode maps multiple local IP addresses to one global IP address. This is equivalent to SUA (i.e., PAT, port address translation), ZyXEL's Single User Account feature that previous ZyXEL routers supported only. Many-to-Many Overload: Many-to-Many Overload mode maps multiple local IP addresses to shared global IP addresses. Many-to-Many No Overload: Many-to-Many No Overload mode maps each local IP address to unique global IP addresses. Server: This type allows you to specify inside servers of different services behind the NAT to be accessible to the outside world.
Local Start IP	This is the starting local IP address (ILA). Local IP addresses are N/A for Server port mapping.
Local End IP	This is the end local IP address (ILA). If your rule is for all local IP addresses, then enter 0.0.0.0 as the Local Start IP address and 255.255.255.255 as the Local End IP address. This field is N/A for One-to-One and Server mapping types.

Global Start IP	This is the starting global IP address (IGA). Enter 0.0.0.0 here if you have a dynamic IP address from your ISP.
Global End IP	This is the ending global IP address (IGA). This field is N/A for One-to-One , Many-to-One and Server mapping types.
Server Mapping Set	Only available when Type is set to Server . Select a number from 1 to 10 from the drop-down menu to choose a server set from the NAT - Address Mapping Rules screen.
Apply	Click Apply to save your changes back to the Prestige.
Cancel	Click Cancel to return to the previously saved settings.
Delete	Click Delete to exit this screen without saving

Chapter 9

Dynamic DNS Setup

This chapter discusses how to configure your Prestige to use Dynamic DNS.

9.1 Dynamic DNS

Dynamic DNS allows you to update your current dynamic IP address with one or many dynamic DNS services so that anyone can contact you (in NetMeeting, CU-SeeMe, etc.). You can also access your FTP server or Web site on your own computer using a DNS-like address (for instance myhost.dhs.org, where myhost is a name of your choice) that will never change instead of using an IP address that changes each time you reconnect. Your friends or relatives will always be able to call you even if they don't know your IP address.

First of all, you need to have registered a dynamic DNS account with www.dyndns.org. This is for people with a dynamic IP from their ISP or DHCP server that would still like to have a DNS name. The Dynamic DNS service provider will give you a password or key.

9.1.1 DYNDNS Wildcard

Enabling the wildcard feature for your host causes *.yourhost.dyndns.org to be aliased to the same IP address as yourhost.dyndns.org. This feature is useful if you want to be able to use, for example, www.yourhost.dyndns.org and still reach your hostname.

If you have a private WAN IP address, then you cannot use Dynamic DNS.

9.2 Configuring Dynamic DNS

To change your Prestige's DDNS, click **Dynamic DNS**. The screen appears as shown.

Dynamic DNS

Active

Service Provider: WWW.DynDNS.ORG

Host Name: _____

E-mail Address: _____

User: _____

Password: _____

Enable Wildcard

Apply Cancel

Figure 9-1 DDNS

The following table describes the fields in this screen.

Table 9-1 DDNS

LABEL	DESCRIPTION
Active	Select this check box to use dynamic DNS.
Service Provider	Select the name of your Dynamic DNS service provider.
Host Names	Type the domain name assigned to your Prestige by your Dynamic DNS provider.
E-mail Address	Type your e-mail address.
User	Type your user name.
Password	Type the password assigned to you.
Enable Wildcard	Select the check box to enable DYNDNS Wildcard.
Apply	Click Apply to save your changes back to the Prestige.
Cancel	Click Cancel to return to the previously saved settings.

Chapter 10

Time Zone

Use this screen to configure the Prestige's time and date settings.

10.1 Configuring Time Zone

To change your Prestige's time and date, click **Time Zone**. The screen appears as shown. Use this screen to configure the Prestige's time based on your local time zone.

Time Zone

Time Server

Use Time Server when Bootup

Time Server IP Address

Time Zone

Daylight Saving

Start Date month day

End Date month day

Calibrate system clock with Time Server now.
(Attention! This may take up to 60 seconds if Time Server is unreachable).

Date

Current Date - -

New Date (yyyy-mm-dd) - -

Time

Current Time : :

New Time : :

Figure 10-1 Time/Date

The following table describes the fields in this screen.

Table 10-1 Time/Date

LABEL	DESCRIPTION
Time Server	
Use Time Server when Bootup	<p>Select the time service protocol that your time server sends when you turn on the Prestige. Not all time servers support all protocols, so you may have to check with your ISP/network administrator or use trial and error to find a protocol that works.</p> <p>The main difference between them is the format. Daytime (RFC 867) format is day/month/year/time zone of the server. Time (RFC 868) format displays a 4-byte integer giving the total number of seconds since 1970/1/1 at 0:0:0. The default, NTP (RFC 1305), is similar to Time (RFC 868). Select None to enter the time and date manually.</p>
Time Server IP Address	Enter the IP address of your time server. Check with your ISP/network administrator if you are unsure of this information (the default is tick.stdtime.gov.tw).
Time Zone	Choose the time zone of your location. This will set the time difference between your time zone and Greenwich Mean Time (GMT).
Daylight Savings	Select this option if you use daylight savings time. Daylight saving is a period from late spring to early fall when many countries set their clocks ahead of normal local time by one hour to give more daytime light in the evening.
Start Date	Enter the month and day that your daylight-savings time starts on if you selected Daylight Savings .
End Date	Enter the month and day that your daylight-savings time ends on if you selected Daylight Savings .
Calibrate system clock with Time Server now	<p>Click this button to have your Prestige use the time server (that you configured above) to set its internal system clock.</p> <p>Please wait for up to 60 seconds while the Prestige locates the time server. If the Prestige cannot find the time server, please check the time server protocol and its IP address. If the IP address was entered correctly, try pinging it for example to test the connection.</p>
Date	
Current Date	This field displays the date of your Prestige. Each time you reload this page, the Prestige synchronizes the time with the time server.

Table 10-1 Time/Date

LABEL	DESCRIPTION
New Date	This field displays the last updated date from the time server. When you select None in the Use Time Server when Bootup field, enter the new date in this field and then click Apply .
Time	
Current Time	This field displays the time of your Prestige. Each time you reload this page, the Prestige synchronizes the time with the time server.
New Time	This field displays the last updated time from the time server. When you select None in the Use Time Server when Bootup field, enter the new time in this field and then click Apply .
Apply	Click Apply to save your changes back to the Prestige.
Cancel	Click Cancel to return to the previously saved settings.

Part IV:

Firewall and Content Filters

This part introduces firewalls in general and the Prestige firewall. It also explains customized services and logs and gives example firewall rules and an overview of content filtering.

Chapter 11

Firewalls

This chapter gives some background information on firewalls and introduces the Prestige firewall.

11.1 Firewall Overview

Originally, the term *firewall* referred to a construction technique designed to prevent the spread of fire from one room to another. The networking term “firewall” is a system or group of systems that enforces an access-control policy between two networks. It may also be defined as a mechanism used to protect a trusted network from a mistrusted network. Of course, firewalls cannot solve every security problem. A firewall is *one* of the mechanisms used to establish a network security perimeter in support of a network security policy. It should never be the *only* mechanism or method employed. For a firewall to guard effectively, you must design and deploy it appropriately. This requires integrating the firewall into a broad information-security policy. In addition, specific policies must be implemented within the firewall itself.

11.2 Types of Firewalls

There are three main types of firewalls:

1. Packet Filtering Firewalls
2. Application-level Firewalls
3. Stateful Inspection Firewalls

11.2.1 Packet Filtering Firewalls

Packet filtering firewalls restrict access based on the source/destination computer network address of a packet and the type of application.

11.2.2 Application-level Firewalls

Application-level firewalls restrict access by serving as proxies for external servers. Since they use programs written for specific Internet services, such as HTTP, FTP and telnet, they can evaluate network packets for valid application-specific data. Application-level gateways have a number of general advantages over the default mode of permitting application traffic directly to internal hosts:

- i. Information hiding prevents the names of internal systems from being made known via DNS to outside systems, since the application gateway is the only host whose name must be made known to outside systems.
- ii. Robust authentication and logging pre-authenticates application traffic before it reaches internal hosts and causes it to be logged more effectively than if it were logged with standard host logging. Filtering rules at the packet filtering router can be less complex than they would be if the router needed to filter application traffic and direct it to a number of specific systems. The router need only allow application traffic destined for the application gateway and reject the rest.

11.2.3 Stateful Inspection Firewalls

Stateful inspection firewalls restrict access by screening data packets against defined access rules. They make access control decisions based on IP address and protocol. They also "inspect" the session data to assure the integrity of the connection and to adapt to dynamic protocols. These firewalls generally provide the best speed and transparency; however, they may lack the granular application level access control or caching that some proxies support. See *section 11.5* for more information on Stateful Inspection.

Firewalls, of one type or another, have become an integral part of standard security solutions for enterprises.

11.3 Introduction to ZyXEL's Firewall

The Prestige firewall is a stateful inspection firewall and is designed to protect against Denial of Service attacks when activated (in SMT menu 21.2 or in the web configurator). The Prestige's purpose is to allow a private Local Area Network (LAN) to be securely connected to the Internet. The Prestige can be used to prevent theft, destruction and modification of data, as well as log events, which may be important to the security of your network. The Prestige also has packet-filtering capabilities.

The Prestige is installed between the LAN and the Internet. This allows it to act as a secure gateway for all data passing between the Internet and the LAN.

The Prestige has one ISDN port and one Ethernet LAN port, which physically separate the network into two areas.

- ❑ The ISDN port connects to the Internet.
- ❑ The LAN (Local Area Network) port attaches to a network of computers, which needs security from the outside world. These computers will have access to Internet services such as e-mail, FTP, and the World Wide Web. However, "inbound access" will not be allowed unless you configure remote management or create a firewall rule to allow a remote host to use a specific service.

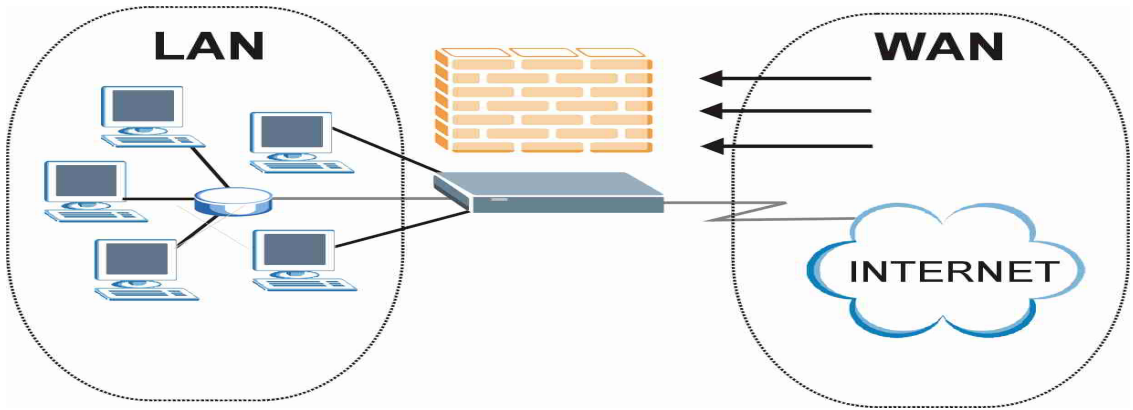

Figure 11-1 Prestige Firewall Application

11.4 Denial of Service

Denials of Service (DoS) attacks are aimed at devices and networks with a connection to the Internet. Their goal is not to steal information, but to disable a device or network so users no longer have access to network resources. The Prestige is pre-configured to automatically detect and thwart all known DoS attacks.

11.4.1 Basics

Computers share information over the Internet using a common language called TCP/IP. TCP/IP, in turn, is a set of application protocols that perform specific functions. An “extension number”, called the "TCP port" or "UDP port" identifies these protocols, such as HTTP (Web), FTP (File Transfer Protocol), POP3 (E-mail), etc. For example, Web traffic by default uses TCP port 80.

When computers communicate on the Internet, they are using the client/server model, where the server "listens" on a specific TCP/UDP port for information requests from remote client computers on the network. For example, a Web server typically listens on port 80. Please note that while a computer may be intended for use over a single port, such as Web on port 80, other ports are also active. If the person configuring or managing the computer is not careful, a hacker could attack it over an unprotected port.

Some of the most common IP ports are:

Table 11-1 Common IP Ports

21	FTP	53	DNS
23	Telnet	80	HTTP
25	SMTP	110	POP3

11.4.2 Types of DoS Attacks

There are four types of DoS attacks:

1. Those that exploit bugs in a TCP/IP implementation.
2. Those that exploit weaknesses in the TCP/IP specification.
3. Brute-force attacks that flood a network with useless data.
4. IP Spoofing.
1. **"Ping of Death"** and **"Teardrop"** attacks exploit bugs in the TCP/IP implementations of various computer and host systems.
 - 1-a Ping of Death uses a "ping" utility to create an IP packet that exceeds the maximum 65,536 bytes of data allowed by the IP specification. The oversize packet is then sent to an unsuspecting system. Systems may crash, hang or reboot.
 - 1-b Teardrop attack exploits weaknesses in the re-assembly of IP packet fragments. As data is transmitted through a network, IP packets are often broken up into smaller chunks. Each fragment looks like the original IP packet except that it contains an offset field that says, for instance, "This fragment is carrying bytes 200 through 400 of the original (non fragmented) IP packet." The Teardrop program creates a series of IP fragments with overlapping offset fields. When these fragments are reassembled at the destination, some systems will crash, hang, or reboot.
2. Weaknesses in the TCP/IP specification leave it open to **"SYN Flood"** and **"LAND"** attacks. These attacks are executed during the handshake that initiates a communication session between two applications.

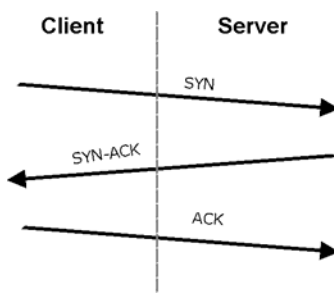
**Figure 11-2 Three-Way Handshake**

Under normal circumstances, the application that initiates a session sends a SYN (synchronize) packet to the receiving server. The receiver sends back an ACK (acknowledgment) packet and its own SYN, and then the initiator responds with an ACK (acknowledgment). After this handshake, a connection is established.

2-a **SYN Attack** floods a targeted system with a series of SYN packets. Each packet causes the targeted system to issue a SYN-ACK response. While the targeted system waits for the ACK that follows the SYN-ACK, it queues up all outstanding SYN-ACK responses on what is known as a backlog queue. SYN-ACKs are moved off the queue only when an ACK comes back or when an internal timer (which is set at relatively long intervals) terminates the three-way handshake. Once the queue is full, the system will ignore all incoming SYN requests, making the system unavailable for legitimate users.

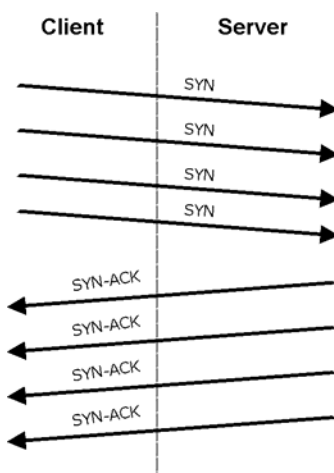
**Figure 11-3 SYN Flood**

2-b In a **LAND Attack**, hackers flood SYN packets into the network with a spoofed source IP address of the targeted system. This makes it appear as if the host computer sent the packets to itself, making the system unavailable while the target system tries to respond to itself.

3. A **brute-force** attack, such as a "Smurf" attack, targets a feature in the IP specification known as directed or subnet broadcasting, to quickly flood the target network with useless data. A Smurf hacker floods a router with Internet Control Message Protocol (ICMP) echo request packets (pings). Since the destination IP address of each packet is the broadcast address of the network, the router will broadcast the ICMP echo request packet to all hosts on the network. If there are numerous hosts, this will create a large amount of ICMP echo request and response traffic. If a hacker chooses to spoof the source IP address of the ICMP echo request packet, the resulting ICMP traffic will not only clog up the "intermediary" network, but will also congest the network of the spoofed source IP address, known as the "victim" network. This flood of broadcast traffic consumes all available bandwidth, making communications impossible.

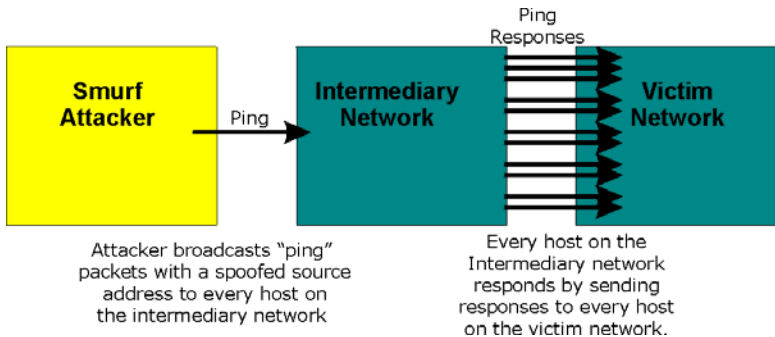

Figure 11-4 Smurf Attack

❑ ICMP Vulnerability

ICMP is an error-reporting protocol that works in concert with IP. The following ICMP types trigger an alert:

Table 11-2 ICMP Commands That Trigger Alerts

5	REDIRECT
13	TIMESTAMP_REQUEST
14	TIMESTAMP_REPLY
17	ADDRESS_MASK_REQUEST
18	ADDRESS_MASK_REPLY

❑ Illegal Commands (NetBIOS and SMTP)

The only legal NetBIOS commands are the following - all others are illegal.

Table 11-3 Legal NetBIOS Commands

MESSAGE:
REQUEST:
POSITIVE:
NEGATIVE:
RETARGET:
KEEPALIVE:

All SMTP commands are illegal except for those displayed in the following tables.

Table 11-4 Legal SMTP Commands

AUTH	DATA	EHLO	ETRN	EXPN	HELO	HELP	MAIL	NOOP
QUIT	RCPT	RSET	SAML	SEND	SOML	TURN	VERFY	

❑ Traceroute

Traceroute is a utility used to determine the path a packet takes between two endpoints. Sometimes when a packet filter firewall is configured incorrectly an attacker can traceroute the firewall gaining knowledge of the network topology inside the firewall.

- Often, many DoS attacks also employ a technique known as "**IP Spoofing**" as part of their attack. IP Spoofing may be used to break into systems, to hide the hacker's identity, or to magnify the effect of the DoS attack. IP Spoofing is a technique used to gain unauthorized access to computers by tricking a router or firewall into thinking that the communications are coming from within the trusted network. To engage in IP spoofing, a hacker must modify the packet headers so that it appears that the packets originate from a trusted host and should be allowed through the router or firewall. The Prestige blocks all IP Spoofing attempts.

11.5 Stateful Inspection

With stateful inspection, fields of the packets are compared to packets that are already known to be trusted. For example, if you access some outside service, the proxy server remembers things about your original request, like the port number and source and destination addresses. This "remembering" is called *saving the state*. When the outside system responds to your request, the firewall compares the received packets with the saved state to determine if they are allowed in. The Prestige uses stateful packet inspection to protect the private LAN from hackers and vandals on the Internet. By default, the Prestige's stateful inspection allows all communications to the Internet that originate from the LAN, and blocks all traffic to the LAN that originates from the Internet. In summary, stateful inspection:

- ❑ Allows all sessions originating from the LAN (local network) to the WAN (Internet).

- Denies all sessions originating from the WAN to the LAN.

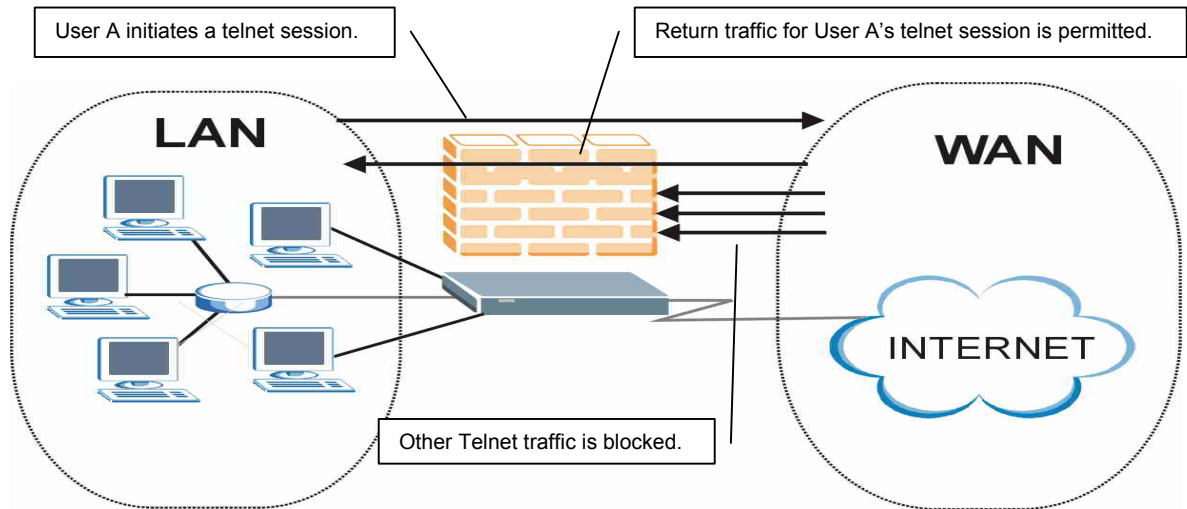

Figure 11-5 Stateful Inspection

The previous figure shows the Prestige's default firewall rules in action as well as demonstrates how stateful inspection works. User A can initiate a Telnet session from within the LAN and responses to this request are allowed. However other Telnet traffic initiated from the WAN is blocked.

11.5.1 Stateful Inspection Process

In this example, the following sequence of events occurs when a TCP packet leaves the LAN network through the firewall's WAN interface. The TCP packet is the first in a session, and the packet's application layer protocol is configured for a firewall rule inspection:

1. The packet travels from the firewall's LAN to the WAN.
2. The packet is evaluated against the interface's existing outbound access list, and the packet is permitted (a denied packet would simply be dropped at this point).
3. The packet is inspected by a firewall rule to determine and record information about the state of the packet's connection. This information is recorded in a new state table entry created for the new connection. If there is not a firewall rule for this packet and it is not an attack, then **The default action for packets not matching following rules** field (see *Figure 13-3*) determines the action for this packet.

4. Based on the obtained state information, a firewall rule creates a temporary access list entry that is inserted at the beginning of the WAN interface's inbound extended access list. This temporary access list entry is designed to permit inbound packets of the same connection as the outbound packet just inspected.
5. The outbound packet is forwarded out through the interface.
6. Later, an inbound packet reaches the interface. This packet is part of the connection previously established with the outbound packet. The inbound packet is evaluated against the inbound access list, and is permitted because of the temporary access list entry previously created.
7. The packet is inspected by a firewall rule, and the connection's state table entry is updated as necessary. Based on the updated state information, the inbound extended access list temporary entries might be modified, in order to permit only packets that are valid for the current state of the connection.
8. Any additional inbound or outbound packets that belong to the connection are inspected to update the state table entry and to modify the temporary inbound access list entries as required, and are forwarded through the interface.
9. When the connection terminates or times out, the connection's state table entry is deleted and the connection's temporary inbound access list entries are deleted.

11.5.2 Stateful Inspection and the Prestige

Additional rules may be defined to extend or override the default rules. For example, a rule may be created which will:

- i. Block all traffic of a certain type, such as IRC (Internet Relay Chat), from the LAN to the Internet.
- ii. Allow certain types of traffic from the Internet to specific hosts on the LAN.
- iii. Allow access to a Web server to everyone but competitors.
- iv. Restrict use of certain protocols, such as Telnet, to authorized users on the LAN.

These custom rules work by evaluating the network traffic's Source IP address, Destination IP address, IP protocol type, and comparing these to rules set by the administrator.

The ability to define firewall rules is a very powerful tool. Using custom rules, it is possible to disable all firewall protection or block all access to the Internet. Use extreme caution when creating or deleting firewall rules. Test changes after creating them to make sure they work correctly.

Below is a brief technical description of how these connections are tracked. Connections may either be defined by the upper protocols (for instance, TCP), or by the Prestige itself (as with the "virtual connections" created for UDP and ICMP).

11.5.3 TCP Security

The Prestige uses state information embedded in TCP packets. The first packet of any new connection has its SYN flag set and its ACK flag cleared; these are "initiation" packets. All packets that do not have this flag structure are called "subsequent" packets, since they represent data that occurs later in the TCP stream.

If an initiation packet originates on the WAN, this means that someone is trying to make a connection from the Internet into the LAN. Except in a few special cases (see "Upper Layer Protocols" shown next), these packets are dropped and logged.

If an initiation packet originates on the LAN, this means that someone is trying to make a connection from the LAN to the Internet. Assuming that this is an acceptable part of the security policy (as is the case with the default policy), the connection will be allowed. A cache entry is added which includes connection information such as IP addresses, TCP ports, sequence numbers, etc.

When the Prestige receives any subsequent packet (from the Internet or from the LAN), its connection information is extracted and checked against the cache. A packet is only allowed to pass through if it corresponds to a valid connection (that is, if it is a response to a connection which originated on the LAN).

11.5.4 UDP/ICMP Security

UDP and ICMP do not themselves contain any connection information (such as sequence numbers). However, at the very minimum, they contain an IP address pair (source and destination). UDP also contains port pairs, and ICMP has type and code information. All of this data can be analyzed in order to build "virtual connections" in the cache.

For instance, any UDP packet that originates on the LAN will create a cache entry. Its IP address and port pairs will be stored. For a short period of time, UDP packets from the WAN that have matching IP and UDP information will be allowed back in through the firewall.

A similar situation exists for ICMP, except that the Prestige is even more restrictive. Specifically, only outgoing echoes will allow incoming echo replies, outgoing address mask requests will allow incoming address mask replies, and outgoing timestamp requests will allow incoming timestamp replies. No other ICMP packets are allowed in through the firewall, simply because they are too dangerous and contain too little tracking information. For instance, ICMP redirect packets are never allowed in, since they could be used to reroute traffic through attacking machines.

11.5.5 Upper Layer Protocols

Some higher layer protocols (such as FTP and RealAudio) utilize multiple network connections simultaneously. In general terms, they usually have a "control connection" which is used for sending commands between endpoints, and then "data connections" which are used for transmitting bulk information.

Consider the FTP protocol. A user on the LAN opens a control connection to a server on the Internet and requests a file. At this point, the remote server will open a data connection from the Internet. For FTP to work properly, this connection must be allowed to pass through even though a connection from the Internet would normally be rejected.

In order to achieve this, the Prestige inspects the application-level FTP data. Specifically, it searches for outgoing "PORT" commands, and when it sees these, it adds a cache entry for the anticipated data connection. This can be done safely, since the PORT command contains address and port information, which can be used to uniquely identify the connection.

Any protocol that operates in this way must be supported on a case-by-case basis. You can use the web configurator's Custom Ports feature to do this.

11.6 Guidelines For Enhancing Security With Your Firewall

1. Change the default password via SMT or web configurator.
2. Think about access control *before* you connect a console port to the network in any way, including attaching a modem to the port. Be aware that a break on the console port might give unauthorized individuals total control of the firewall, even with access control configured.
3. Limit who can telnet into your router.
4. Don't enable any local service (such as SNMP or NTP) that you don't use. Any enabled service could present a potential security risk. A determined hacker might be able to find creative ways to misuse the enabled services to access the firewall or the network.
5. For local services that are enabled, protect against misuse. Protect by configuring the services to communicate only with specific peers, and protect by configuring rules to block packets for the services at specific interfaces.
6. Protect against IP spoofing by making sure the firewall is active.
7. Keep the firewall in a secured (locked) room.

11.6.1 Security In General

You can never be too careful! Factors outside your firewall, filtering or NAT can cause security breaches. Below are some generalizations about what you can do to minimize them.

1. Encourage your company or organization to develop a comprehensive security plan. Good network administration takes into account what hackers can do and prepares against attacks. The best defense against hackers is information. Educate all employees about the importance of security and how to minimize risk. Produce lists like this one!
2. DSL or cable modem connections are “always-on” connections and are particularly vulnerable because they provide more opportunities for hackers to break in to your system. Turn your computer off when not in use.
3. Never give out a password or any sensitive information to an unsolicited telephone call or e-mail.
4. Never e-mail sensitive information such as passwords, credit card information, etc., without encrypting the information first.
5. Never submit sensitive information via a web page unless the web site uses secure connections. You can identify a secure connection by looking for a small “key” icon on the bottom of your browser (Internet Explorer 3.02 or better or Netscape 3.0 or better). If a web site uses a secure connection, it is safe to submit information. Secure web transactions are quite difficult to hack.
6. Never reveal your IP address or other system networking information to people outside your company. Be careful of files e-mailed to you from strangers. One common way of getting BackOrifice on a system is to include it as a Trojan horse with other files.
7. Change your passwords regularly. Also, use passwords that are not easy to figure out. The most difficult passwords to crack are those with upper and lower case letters, numbers and a symbol such as % or #.
8. Upgrade your software regularly. Many older versions of software, especially web browsers, have well known security deficiencies. When you upgrade to the latest versions, you get the latest patches and fixes.
9. If you use “chat rooms” or IRC sessions, be careful with any information you reveal to strangers.
10. If your system starts exhibiting odd behavior, contact your ISP. Some hackers will set off hacks that cause your system to slowly become unstable or unusable.
11. Always shred confidential information, particularly about your computer, before throwing it away. Some hackers dig through the trash of companies or individuals for information that might help them in an attack.

11.7 Packet Filtering Vs Firewall

Below are some comparisons between the Prestige's filtering and firewall functions.

11.7.1 Packet Filtering:

- ❑ The router filters packets as they pass through the router's interface according to the filter rules you designed.
- ❑ Packet filtering is a powerful tool, yet can be complex to configure and maintain, especially if you need a chain of rules to filter a service.

- ❑ Packet filtering only checks the header portion of an IP packet.

When To Use Filtering

1. To block/allow LAN packets by their MAC addresses.
2. To block/allow special IP packets which are neither TCP nor UDP, nor ICMP packets.
3. To block/allow both inbound (WAN to LAN) and outbound (LAN to WAN) traffic between the specific inside host/network "A" and outside host/network "B". If the filter blocks the traffic from A to B, it also blocks the traffic from B to A. Filters cannot distinguish traffic originating from an inside host or an outside host by IP address.
4. To block/allow IP trace route.

11.7.2 Firewall

- ❑ The firewall inspects packet contents as well as their source and destination addresses. Firewalls of this type employ an inspection module, applicable to all protocols, that understands data in the packet is intended for other layers, from the network layer (IP headers) up to the application layer.
- ❑ The firewall performs stateful inspection. It takes into account the state of connections it handles so that, for example, a legitimate incoming packet can be matched with the outbound request for that packet and allowed in. Conversely, an incoming packet masquerading as a response to a nonexistent outbound request can be blocked.
- ❑ The firewall uses session filtering, i.e., smart rules, that enhance the filtering process and control the network session rather than control individual packets in a session.
- ❑ The firewall provides e-mail service to notify you of routine reports and when alerts occur.

When To Use The Firewall

1. To prevent DoS attacks and prevent hackers cracking your network.
2. A range of source and destination IP addresses as well as port numbers can be specified within one firewall rule making the firewall a better choice when complex rules are required.
3. To selectively block/allow inbound or outbound traffic between inside host/networks and outside host/networks. Remember that filters cannot distinguish traffic originating from an inside host or an outside host by IP address.
4. The firewall performs better than filtering if you need to check many rules.
5. Use the firewall if you need routine e-mail reports about your system or need to be alerted when attacks occur.

6. The firewall can block specific URL traffic that might occur in the future. The URL can be saved in an Access Control List (ACL) database.

Chapter 12

Firewall Configuration

This chapter shows you how to enable and configure the Prestige firewall.

12.1 Remote Management and the Firewall

When remote management is configured to allow management (see the *Remote Management* chapter) and the firewall is enabled:

- The firewall blocks remote management from the WAN unless you configure a firewall rule to allow it.
- The firewall allows remote management from the LAN.

12.2 Enabling the Firewall

Click **Advanced Setup**, **Firewall**, and then **Config** to display the following screen. Select the **Firewall Enabled** check box and click **Apply** to enable (or activate) the firewall.

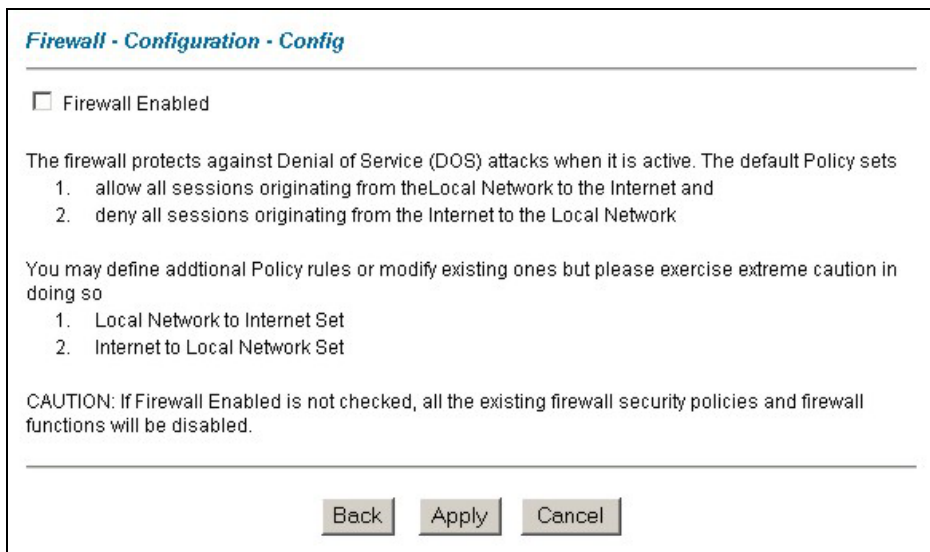

The screenshot shows a window titled "Firewall - Configuration - Config". At the top, there is a horizontal line. Below it is a checkbox labeled "Firewall Enabled". Underneath the checkbox, there is a paragraph: "The firewall protects against Denial of Service (DOS) attacks when it is active. The default Policy sets". This is followed by a numbered list: "1. allow all sessions originating from the Local Network to the Internet and", "2. deny all sessions originating from the Internet to the Local Network". Below this list is another paragraph: "You may define additional Policy rules or modify existing ones but please exercise extreme caution in doing so". This is followed by another numbered list: "1. Local Network to Internet Set", "2. Internet to Local Network Set". At the bottom of the window, there is a "CAUTION" note: "CAUTION: If Firewall Enabled is not checked, all the existing firewall security policies and firewall functions will be disabled." At the very bottom of the window, there are three buttons: "Back", "Apply", and "Cancel".

Figure 12-1 Enabling the Firewall

12.3 Attack Alert

Attack alerts are real-time reports of DoS attacks. In the **Attack Alert** screen, shown later, you may choose to generate an alert whenever an attack is detected. For DoS attacks, the Prestige uses thresholds to determine when to drop sessions that do not become fully established. These thresholds apply globally to all sessions.

You can use the default threshold values, or you can change them to values more suitable to your security requirements.

12.3.1 Alerts

Alerts are reports on events, such as attacks, that you may want to know about right away. You can choose to generate an alert when an attack is detected in the **Attack Alert** screen (*Figure 12-2* - select the **Generate alert when attack detected** checkbox) or when a rule is matched in the **Rule Config** screen (see *Figure 13-4*). Configure the **Log Settings** screen to have the Prestige send an immediate e-mail message to you when an event generates an alert. Refer to the chapter on logs for details.

12.3.2 Threshold Values

Tune these parameters when something is not working and after you have checked the firewall counters. These default values should work fine for most small offices. Factors influencing choices for threshold values are:

1. The maximum number of opened sessions.
2. The minimum capacity of server backlog in your LAN network.
3. The CPU power of servers in your LAN network.
4. Network bandwidth.
5. Type of traffic for certain servers.

If your network is slower than average for any of these factors (especially if you have servers that are slow or handle many tasks and are often busy), then the default values should be reduced.

You should make any changes to the threshold values before you continue configuring firewall rules.

12.3.3 Half-Open Sessions

An unusually high number of half-open sessions (either an absolute number or measured as the arrival rate) could indicate that a Denial of Service attack is occurring. For TCP, "half-open" means that the session has not reached the established state-the TCP three-way handshake has not yet been completed (see *Figure 11-2*). For UDP, "half-open" means that the firewall has detected no return traffic.

The Prestige measures both the total number of existing half-open sessions and the rate of session establishment attempts. Both TCP and UDP half-open sessions are counted in the total number and rate measurements. Measurements are made once a minute.

When the number of existing half-open sessions rises above a threshold (**max-incomplete high**), the Prestige starts deleting half-open sessions as required to accommodate new connection requests. The Prestige continues to delete half-open requests as necessary, until the number of existing half-open sessions drops below another threshold (**max-incomplete low**).

When the rate of new connection attempts rises above a threshold (**one-minute high**), the Prestige starts deleting half-open sessions as required to accommodate new connection requests. The Prestige continues to delete half-open sessions as necessary, until the rate of new connection attempts drops below another threshold (**one-minute low**). The rate is the number of new attempts detected in the last one-minute sample period.

TCP Maximum Incomplete and Blocking Time

An unusually high number of half-open sessions with the same destination host address could indicate that a Denial of Service attack is being launched against the host.

Whenever the number of half-open sessions with the same destination host address rises above a threshold (**TCP Maximum Incomplete**), the Prestige starts deleting half-open sessions according to one of the following methods:

1. If the **Blocking Time** timeout is 0 (the default), then the Prestige deletes the oldest existing half-open session for the host for every new connection request to the host. This ensures that the number of half-open sessions to a given host will never exceed the threshold.
2. If the **Blocking Time** timeout is greater than 0, then the Prestige blocks all new connection requests to the host giving the server time to handle the present connections. The Prestige continues to block all new connection requests until the **Blocking Time** expires.

The Prestige also sends alerts whenever **TCP Maximum Incomplete** is exceeded. The global values specified for the threshold and timeout apply to all TCP connections. Click **Advanced Setup**, **Firewall**, and **Alert** to bring up the next screen.

Firewall - Configuration - Alert

The firewall is set by default to prevent attacks on your network. Any detected attacks will automatically generate a log entry. You can also choose to generate an alert whenever such an attack is detected.

Generate alert when attack detected

Denial of Service Thresholds

One Minute Low :

One Minute High :

Maximum Incomplete Low :

Maximum Incomplete High :

TCP Maximum Incomplete :

Blocking Time (minute)

Figure 12-2 Attack Alert

The following table describes the fields in this screen.

Table 12-1 Attack Alert

LABEL	DESCRIPTION
Generate alert when attack detected	Select this check box to generate an alert whenever an attack is detected.
Denial of Services Thresholds	
One Minute Low	This is the rate of new half-open sessions that causes the firewall to stop deleting half-open sessions. The Prestige continues to delete half-open sessions as necessary, until the rate of new connection attempts drops below this number. "80" is the default.
One Minute High	This is the rate of new half-open sessions that causes the firewall to start deleting half-open sessions. The default is "100". When the rate of new connection attempts rises above this number, the Prestige deletes half-open sessions as required to accommodate new connection attempts. The Prestige stops deleting half-open sessions when the number is less than the One Minute Low .

Table 12-1 Attack Alert

LABEL	DESCRIPTION
Maximum Incomplete Low	This is the number of existing half-open sessions (default "80") that causes the firewall to stop deleting half-open sessions. The Prestige continues to delete half-open requests as necessary, until the number of existing half-open sessions drops below this number.
Maximum Incomplete High	This is the number of existing half-open sessions (default "100") that causes the firewall to start deleting half-open sessions. When the number of existing half-open sessions rises above this number, the Prestige deletes half-open sessions as required to accommodate new connection requests. The Prestige stops deleting half-open sessions when the number is less than the Max Incomplete Low . Do not set Maximum Incomplete High to lower than the current Max Incomplete Low number.
TCP Maximum Incomplete	This is the number of existing half-open TCP sessions (default "10") with the same destination host IP address that causes the firewall to start dropping half-open sessions to that same destination host IP address. Enter a number between 1 and 256 . As a general rule, you should choose a smaller number for a smaller network, a slower system or limited bandwidth.
Blocking Time	When TCP Maximum Incomplete is reached you can choose if the next session should be allowed or blocked. If you select Blocking Time , any new sessions will be blocked for the length of time you specify in the next field (min) and all old incomplete sessions will be cleared during this period. If you want strong security, it is better to block the traffic for a short time, as it will give the server some time to digest the loading.
(min)	Type the length of Blocking Time in minutes (1-256). The default is "0".
Back	Click Back to return to the previous screen.
Apply	Click Apply to save your customized settings and exit this screen.
Cancel	Click Cancel to return to the previously saved settings.

Chapter 13

Creating Custom Rules

This chapter contains instructions for defining both Local Network and Internet rules.

13.1 Rules Overview

Firewall rules are subdivided into “Local Network” and “Internet”. By default, the Prestige’s stateful packet inspection allows all communications to the Internet that originate from the local network, and blocks all traffic to the LAN that originates from the Internet. You may define additional rules and sets or modify existing ones but please exercise extreme caution in doing so.

You might inadvertently introduce security risks to the firewall and to the protected network, if you try to configure rules without a good understanding of how rules work. Make sure you test your rules after you configure them.

For example, you may create rules to:

- ◆ Block certain types of traffic, such as IRC (Internet Relay Chat), from the LAN to the Internet.
- ◆ Allow certain types of traffic, such as Lotus Notes database synchronization, from specific hosts on the Internet to specific hosts on the LAN.
- ◆ Allow everyone except your competitors to access a Web server.
- ◆ Restrict use of certain protocols, such as Telnet, to authorized users on the LAN.

These custom rules work by comparing network traffic’s Source IP address, Destination IP address, IP protocol type to rules set by the administrator. Your customized rules take precedence, and may override the Prestige’s default rules.

13.2 Rule Logic Overview

Study these points carefully before configuring rules.

13.2.1 Rule Checklist

1. State the intent of the rule. For example, “This restricts all IRC access from the LAN to the Internet.” Or, “This allows a remote Lotus Notes server to synchronize over the Internet to an inside Notes server.”
2. Is the intent of the rule to forward or block traffic?

3. What is the direction connection: from the LAN to the Internet, or from the Internet to the LAN?
4. What IP services will be affected?
5. What computers on the LAN are to be affected (if any)?
6. What computers on the Internet will be affected? The more specific, the better. For example, if traffic is being allowed from the Internet to the LAN, it is better to allow only certain machines on the Internet to access the LAN.

13.2.2 Security Ramifications

Once the logic of the rule has been defined, it is critical to consider the security ramifications created by the rule:

1. Does this rule stop LAN users from accessing critical resources on the Internet? For example, if IRC is blocked, are there users that require this service?
2. Is it possible to modify the rule to be more specific? For example, if IRC is blocked for all users, will a rule that blocks just certain users be more effective?
3. Does a rule that allows Internet users access to resources on the LAN create a security vulnerability? For example, if FTP ports (TCP 20, 21) are allowed from the Internet to the LAN, Internet users may be able to connect to computers with running FTP servers.
4. Does this rule conflict with any existing rules?

Once these questions have been answered, adding rules is simply a matter of plugging the information into the correct fields in the **Rules** screen in the web configurator.

13.2.3 Key Fields For Configuring Rules

Action

Should the action be to **Block** or **Forward**?

“Block” means the firewall silently discards the packet.

Service

Select the service from the **Service** scrolling list box. If the service is not listed, it is necessary to first define it. See *section 13.6* for more information on predefined services.

Source Address

What is the connection's source address; is it on the LAN or WAN? Is it a single IP, a range of IPs or a subnet?

Destination Address

What is the connection's destination address; is it on the LAN or WAN? Is it a single IP, a range of IPs or a subnet?

13.3 Connection Direction

This section talks about configuring firewall rules for connections going from LAN to WAN and WAN to LAN in your firewall.

13.3.1 LAN to WAN Rules

The default rule for LAN to WAN traffic is that all users on the LAN are allowed non-restricted access to the WAN. When you configure Policy -> LAN to WAN -> Rules, you in essence want to limit some or all users from accessing certain services on the WAN. See the following figure.

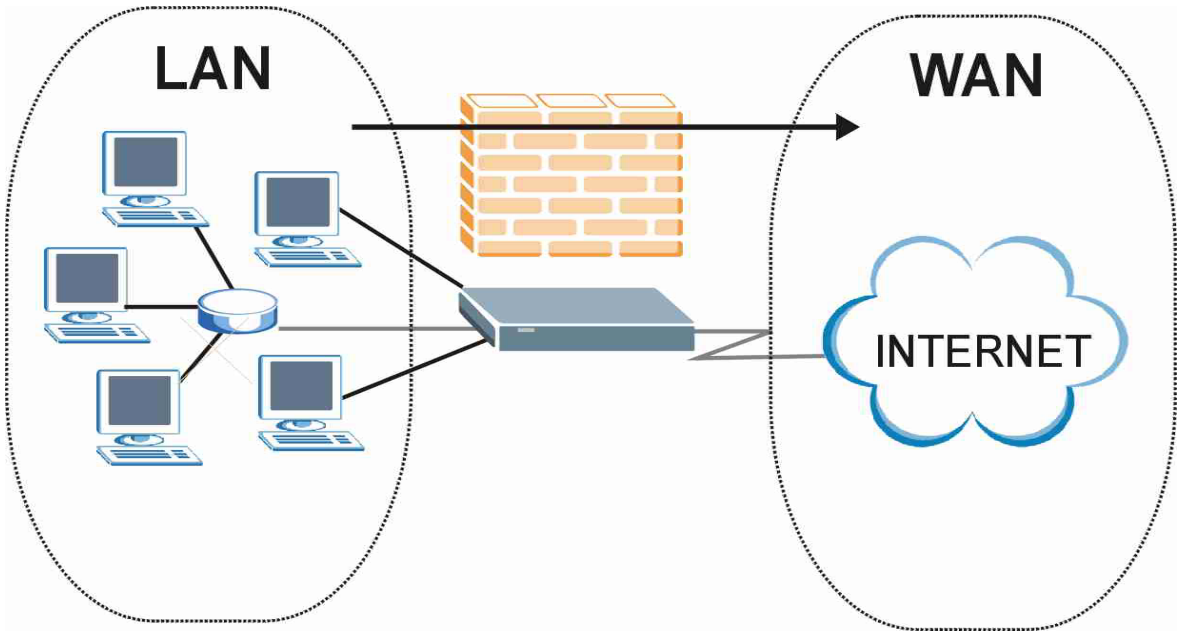

Figure 13-1 LAN to WAN Traffic

13.3.2 WAN to LAN Rules

The default rule for WAN to LAN traffic blocks all incoming connections (WAN to LAN). If you wish to allow certain WAN users to have access to your LAN, you will need to create custom rules to allow it.

See the following figure.

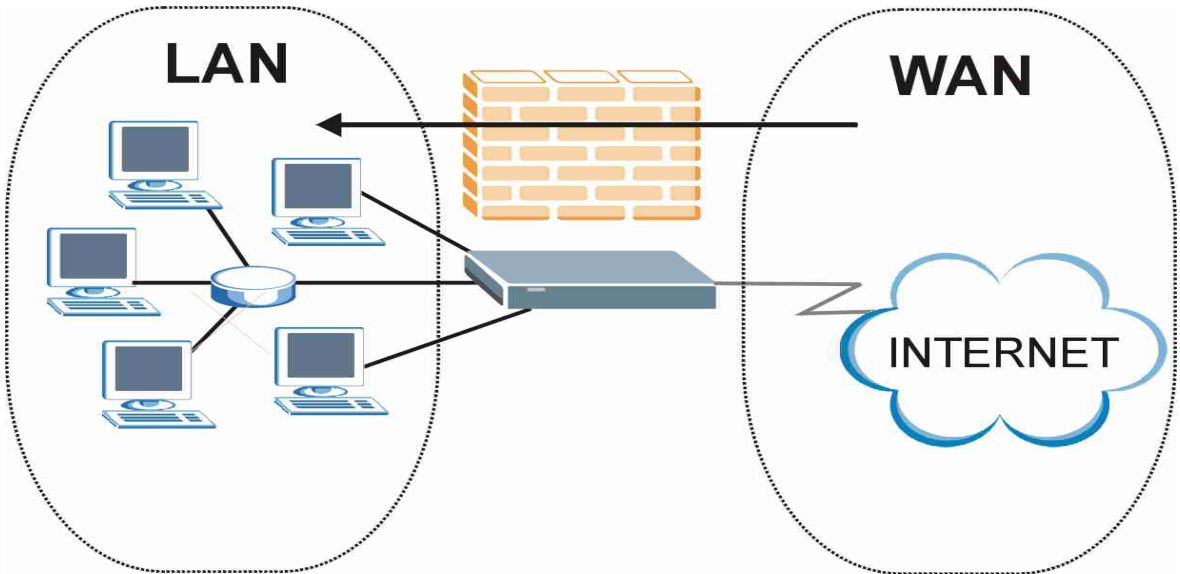

Figure 13-2 WAN to LAN Traffic

13.4 Logs

A log is a detailed record that you create for packets that either match a rule, don't match a rule or both when you are creating/editing a firewall rule (see *Figure 13-4*). You can also choose not to create a log for a rule in this screen. An attack automatically generates a log. Logs can be sent to an e-mail account or syslog server that you specify in the **Log Settings** screen (see the chapter on logs).

13.5 Rule Summary

The fields in the Rule Summary screens are the same for Local Network and Internet, so the discussion below refers to both.

Click on **Firewall**, then **Rule Summary** to bring up the following screen. This screen is a summary of the existing rules. Note the order in which the rules are listed.

The ordering of your rules is very important as rules are applied in turn.

Firewall - LAN to WAN - Rule Summary

The default action for packets not matching following rules:

Default Permit Log

No.	Source IP	Destination IP	Service	Action	Log
1	<input type="text"/>	<input type="text"/>	<input type="text"/>		
2	<input type="text"/>	<input type="text"/>	<input type="text"/>		
3	<input type="text"/>	<input type="text"/>	<input type="text"/>		
4	<input type="text"/>	<input type="text"/>	<input type="text"/>		
5	<input type="text"/>	<input type="text"/>	<input type="text"/>		
6	<input type="text"/>	<input type="text"/>	<input type="text"/>		
7	<input type="text"/>	<input type="text"/>	<input type="text"/>		
8	<input type="text"/>	<input type="text"/>	<input type="text"/>		
9	<input type="text"/>	<input type="text"/>	<input type="text"/>		
10	<input type="text"/>	<input type="text"/>	<input type="text"/>		

Rules Reorder: Move rule number to rule number

Figure 13-3 Firewall Rules Summary: First Screen

The following table describes the fields in this screen.

Table 13-1 Firewall Rules Summary: First Screen

LABEL	DESCRIPTION
The default action for packets not matching following rules	Use the drop-down list box to select whether to Block (silently discard) or Forward (allow the passage of) packets that do not match the following rules.
Default Permit Log	Select this check box to log all matched rules in the default set.
The following fields summarize the rules you have created. Note that these fields are read only. Click the tab at the top of the box to order the rules according to that tab.	

Table 13-1 Firewall Rules Summary: First Screen

LABEL	DESCRIPTION
No.	This is your firewall rule number. The ordering of your rules is important as rules are applied in turn. The Move field below allows you to reorder your rules. Click a rule's number to edit the rule.
Source IP	This is the source address of the packet. Please note that a blank source or destination address is equivalent to Any .
Destination IP	This is the destination address of the packet. Please note that a blank source or destination address is equivalent to Any .
Service	This is the service to which the rule applies. See <i>Table 13-2</i> for more information.
Action	This is the specified action for that rule, whether to Block (discard) or Forward (allow the passage of) packets.
Log	This field shows you if a log is created for packets that match the rule (Match), don't match the rule (Not Match), both (Both) or no log is created (None).
Rules Reorder	You may reorder your rules using this function. Use the drop-down list box to select the number of the rule you want to move. The ordering of your rules is important as rules are applied in turn.
To Rule Number	Use the drop-down list box to select to where you want to move the rule.
Move	Click Move to move the rule.
Back	Click Back to return to the previous screen.
Apply	Click Apply to save your changes back to the Prestige.
Cancel	Click Cancel to return to the previously saved settings.

13.6 Predefined Services

The **Available Services** list box in the **Edit Rule** screen (see *Figure 13-4*) displays all predefined services that the Prestige already supports. Next to the name of the service, two fields appear in brackets. The first field indicates the IP protocol type (TCP, UDP, or ICMP). The second field indicates the IP port number that defines the service. (Note that there may be more than one IP protocol type. For example, look at the default configuration labeled “(DNS)”. **(UDP/TCP:53)** means UDP port 53 and TCP port 53. Up to 128 entries are supported. Custom services may also be configured using the **Custom Ports** function discussed later.

Table 13-2 Predefined Services

SERVICE	DESCRIPTION
AIM(TCP:5190)	AOL's Internet Messenger service, used as a listening port by ICQ.
BGP(TCP:179)	Border Gateway Protocol.
BOOTP_CLIENT(UDP:68)	DHCP Client.
BOOTP_SERVER(UDP:67)	DHCP Server.
CU-SEEME(TCP/UDP:7648, 24032)	A popular videoconferencing solution from White Pines Software.
DNS(UDP/TCP:53)	Domain Name Server, a service that matches web names (e.g. www.zyxel.com) to IP numbers.
FINGER(TCP:79)	Finger is a UNIX or Internet related command that can be used to find out if a user is logged on.
FTP(TCP:20.21)	File Transfer Program, a program to enable fast transfer of files, including large files that may not be possible by e-mail.
H.323(TCP:1720)	Net Meeting uses this protocol.
HTTP(TCP:80)	Hyper Text Transfer Protocol - a client/server protocol for the world wide web.
HTTPS	HTTPS is a secured http session often used in e-commerce.
ICQ(UDP:4000)	This is a popular Internet chat program.
IKE(UDP:500)	The Internet Key Exchange algorithm is used for key distribution and management.
IPSEC_TUNNEL(ESP:0)	The IPSEC ESP (Encapsulation Security Protocol) tunneling protocol uses this service.
IRC(TCP/UDP:6667)	This is another popular Internet chat program.
MSN Messenger(TCP:1863)	Microsoft Networks' messenger service uses this protocol.
MULTICAST(IGMP:0)	Internet Group Multicast Protocol is used when sending packets to a specific group of hosts.
NEWS(TCP:144)	A protocol for news groups.
NFS(UDP:2049)	Network File System - NFS is a client/server distributed file service that provides transparent file sharing for network environments.

Table 13-2 Predefined Services

SERVICE	DESCRIPTION
NNTP(TCP:119)	Network News Transport Protocol is the delivery mechanism for the USENET newsgroup service.
PING(ICMP:0)	Packet Internet Groper is a protocol that sends out ICMP echo requests to test whether or not a remote host is reachable.
POP3(TCP:110)	Post Office Protocol version 3 lets a client computer get e-mail from a POP3 server through a temporary connection (TCP/IP or other).
PPTP(TCP:1723)	Point-to-Point Tunneling Protocol enables secure transfer of data over public networks. This is the control channel.
PPTP_TUNNEL(GRE:0)	Point-to-Point Tunneling Protocol enables secure transfer of data over public networks. This is the data channel.
RCMD(TCP:512)	Remote Command Service.
REAL_AUDIO(TCP:7070)	A streaming audio service that enables real time sound over the web.
REXEC(TCP:514)	Remote Execution Daemon.
RLOGIN(TCP:513)	Remote Login.
RTELNET(TCP:107)	Remote Telnet.
RTSP(TCP/UDP:554)	The Real Time Streaming (media control) Protocol (RTSP) is a remote control for multimedia on the Internet.
SFTP(TCP:115)	Simple File Transfer Protocol.
SMTP(TCP:25)	Simple Mail Transfer Protocol is the message-exchange standard for the Internet. SMTP enables you to move messages from one e-mail server to another.
SNMP(TCP/UDP:161)	Simple Network Management Program.
SNMP-TRAPS(TCP/UDP:162)	Traps for use with the SNMP (RFC:1215).
SQL-NET(TCP:1521)	Structured Query Language is an interface to access data on many different types of database systems, including mainframes, midrange systems, UNIX systems and network servers.
SSH(TCP/UDP:22)	Secure Shell Remote Login Program.
STRM WORKS(UDP:1558)	Stream Works Protocol.

Table 13-2 Predefined Services

SERVICE	DESCRIPTION
TACACS(UDP:49)	Login Host Protocol used for (Terminal Access Controller Access Control System).
TELNET(TCP:23)	Telnet is the login and terminal emulation protocol common on the Internet and in UNIX environments. It operates over TCP/IP networks. Its primary function is to allow users to log into remote host systems.
TFTP(UDP:69)	Trivial File Transfer Protocol is an Internet file transfer protocol similar to FTP, but uses the UDP (User Datagram Protocol) rather than TCP (Transmission Control Protocol).
VDOLIVE(TCP:7000)	Another videoconferencing solution.

13.7 Creating/Editing Firewall Rules

To create a new rule, click a number (**No.**) in the last screen shown to display the following screen.

Firewall - LAN to WAN - Edit Rule 1

Source Address:

Source IP Address #####
Any

Destination Address:

Destination IP Address ####
Any

Service:

Available Services:

AIM/NEW-ICQ(TCP:5190)
AUTH(TCP:113)
BGP(TCP:179)
BOOTP_CLIENT(UDP:68)
BOOTP_SERVER(UDP:67)

[Edit Available Service](#)

<< >>

Selected Services:

Any(UDP)
Any(TCP)

Action for Matched Packets:

Log:

Alert

Figure 13-4 Creating/Editing A Firewall Rule

The following table describes the fields in this screen.

Table 13-3 Creating/Editing A Firewall Rule

LABEL	DESCRIPTION
Source Address	Click SrcAdd to add a new address, SrcEdit to edit an existing one or SrcDelete to delete one.

Table 13-3 Creating/Editing A Firewall Rule

LABEL	DESCRIPTION
Destination Address	Click DestAdd to add a new address, DestEdit to edit an existing one or DestDelete to delete one.
Services	Select a service in the Available Services box on the left, then click >> to select. The selected service shows up on the Selected Services box on the right. To remove a service, click on it in the Selected Services box on the right, then click <<.
Edit Available Service	Click this button to go to the Customized Services screen. Refer to the <i>Chapter 14</i> for more information.
Action for Matched Packets	Use the drop down list box to select whether to Block (silently discard) or Forward (allow the passage of) packets that match this rule.
Log	This field determines if a log is created for packets that match the rule (Match), don't match the rule (Not Match), match either rule (Both) or no log is created (None).
Alert	Select the Alert check box to determine that this rule generates an alert when the rule is matched.
Apply	Click Apply to save your changes back to the Prestige.
Cancel	Click Cancel to exit this screen without saving.
Delete	Click Delete to remove the current rule.

13.7.1 Source and Destination Addresses

To add a new source or destination address, click **SrcAdd** or **DestAdd** from the previous screen. To edit an existing source or destination address, select it from the box and click **SrcEdit** or **DestEdit** from the previous screen. Either action displays the following screen.

Firewall - LAN to WAN - Rule IP Config

Address Type:

Start IP Address:

End IP Address:

Subnet Mask:

Figure 13-5 Adding/Editing Source and Destination Addresses

The following table describes the fields in this screen.

Table 13-4 Adding/Editing Source and Destination Addresses

LABEL	DESCRIPTION
Address Type	Do you want your rule to apply to packets with a particular (single) IP address, a range of IP addresses (e.g., 192.168.1.10 to 192.169.1.50), a subnet or any IP address? Select an option from the drop-down list box that includes: Single Address, Range Address, Subnet Address and Any Address .
Start IP Address	Type the single IP address or the starting IP address in a range here.
End IP Address	Type the ending IP address in a range here.
Subnet Mask	Type the Subnet Mask here, if applicable.
Apply	Click Apply to save your changes back to the Prestige.
Cancel	Click Cancel to return to the previously saved settings.

13.8 Timeout

The fields in the Timeout screens are the same for Local and Internet networks, so the discussion below refers to both.

13.8.1 Factors Influencing Choices for Timeout Values

The factors influencing choices for timeout values are the same as the factors influencing choices for threshold values – see *section 12.3.2*. Click **Timeout** for either **Local Network** or **Internet**.

Firewall - LAN to WAN - Timeout

TCP Timeout Values

Connection Timeout: (sec)

FIN-Wait Timeout: (sec)

Idle Timeout: (sec)

UDP Idle Timeout: (sec)

ICMP Timeout: (sec)

Figure 13-6 Timeout

The following table describes the fields in this screen.

Table 13-5 Timeout

LABEL	DESCRIPTION
TCP Timeout Values	
Connection Timeout	Type the number of seconds (default 30) for the Prestige to wait for a TCP session to reach the established state before dropping the session.
FIN-Wait Timeout	Type the number of seconds (default 60) for a TCP session to remain open after the firewall detects a FIN-exchange (indicating the end of the TCP session).
Idle Timeout	Type the number of seconds (default 3600) for an inactive TCP connection to remain open before the Prestige considers the connection closed.
UDP Idle Timeout	Type the number of seconds (default 60) for an inactive UDP connection to remain open before the Prestige considers the connection closed.
ICMP Timeout	Type the number of seconds (default 60) for an ICMP session to wait for the ICMP response.

Table 13-5 Timeout

LABEL	DESCRIPTION
Back	Click Back to return to the previous screen.
Apply	Click Apply to save your customized settings and exit this screen.
Cancel	Click Cancel to return to the previous configuration.

Chapter 14

Customized Services

This chapter covers creating, viewing and editing custom services.

14.1 Introduction to Customized Services

Configure customized services and port numbers not predefined by the Prestige (see *Figure 13-4*). For a comprehensive list of port numbers and services, visit the IANA (Internet Assigned Number Authority) website. For further information on these services, please read *section 13.6*. To configure a custom service, click **Edit Available Service** in an edit rule screen to bring up the following screen.

Firewall - Customized Services

No.	Name	Protocol	Port
1			
2			
3			
4			
5			
6			
7			
8			
9			
10			

Back

Figure 14-1 Customized Services

The next table describes the fields in this screen.

Table 14-1 Customized Services

LABEL	DESCRIPTION
Customized Services	
No.	This is the number of your customized port. Click a rule's number of a service to go to the Firewall Customized Services Config screen to configure or edit a customized service.
Name	This is the name of your customized service.
Protocol	This shows the IP protocol (TCP , UDP or Both) that defines your customized service.
Port	This is the port number or range that defines your customized service.
Back	Click Back to return the Firewall Edit Rule screen.

14.2 Creating/Editing A Customized Service

Click a rule number in the previous screen to create a new custom port or edit an existing one. This action displays the following screen.

The screenshot shows the 'Firewall - Customized Services - Config' screen. It features a title bar at the top. Below the title bar, there are two main sections. The first section contains 'Service Name:' followed by a text input field, and 'Service Type:' followed by a dropdown menu currently set to 'TCP/UDP'. The second section is titled 'Port Configuration' and includes 'Type:' with radio buttons for 'Single' (selected) and 'Range', and 'Port Number:' followed by two text input fields separated by a hyphen, both containing the number '0'. At the bottom of the screen, there are four buttons: 'Back', 'Apply', 'Cancel', and 'Delete'.

Figure 14-2 Creating/Editing A Customized Service

The next table describes the fields in this screen.

Table 14-2 Creating/Editing A Customized Service

LABEL	DESCRIPTION
Service Name	Type a unique name for your custom port.
Service Type	Choose the IP port (TCP , UDP or TCP/UDP) that defines your customized port from the drop down list box.
Port Configuration	
Type	Click Single to specify one port only or Range to specify a span of ports that define your customized service.
Port Number	Type a single port number or the range of port numbers that define your customized service.
Back	Click Back to return to the Firewall Customized Services screen.
Apply	Click Apply to save your customized settings and exit this screen.
Cancel	Click Cancel to return to the previously saved settings.
Delete	Click Delete to delete the current rule.

14.3 Example Custom Service Firewall Rule

The following Internet firewall rule example allows a hypothetical “My Service” connection from the Internet.

- Step 1.** Click **Rule Summary** under **Internet to Local Network Set**.
- Step 2.** Click a rule number to open the edit rule screen.
- Step 3.** Click **Any** in the **Source Address** box and then click **ScrDelete**.
- Step 4.** Click **ScrAdd** to open the **Rule IP Config** screen. Configure it as follows and click **Apply**.

Firewall - WAN to LAN - Rule IP Config

Address Type:

Start IP Address:

End IP Address:

Subnet Mask:

Figure 14-3 Configure Source IP Example

Step 5. Click **Edit Available Service** in the **Edit rule** screen and then click a rule number to bring up the **Firewall Customized Services Config** screen. Configure as follows.

Firewall - Customized Services - Config

Service Name:

Service Type:

Port Configuration

Type: Single Range

Port Number: -

Figure 14-4 Customized Service for MyService Example

Customized services show up with an “*” before their names in the Services list box and the Rule Summary list box. Click Apply after you’ve created your customized service.

Step 6. Follow the procedures outlined earlier in this chapter to configure all your rules. Configure the rule configuration screen like the one below and apply it.

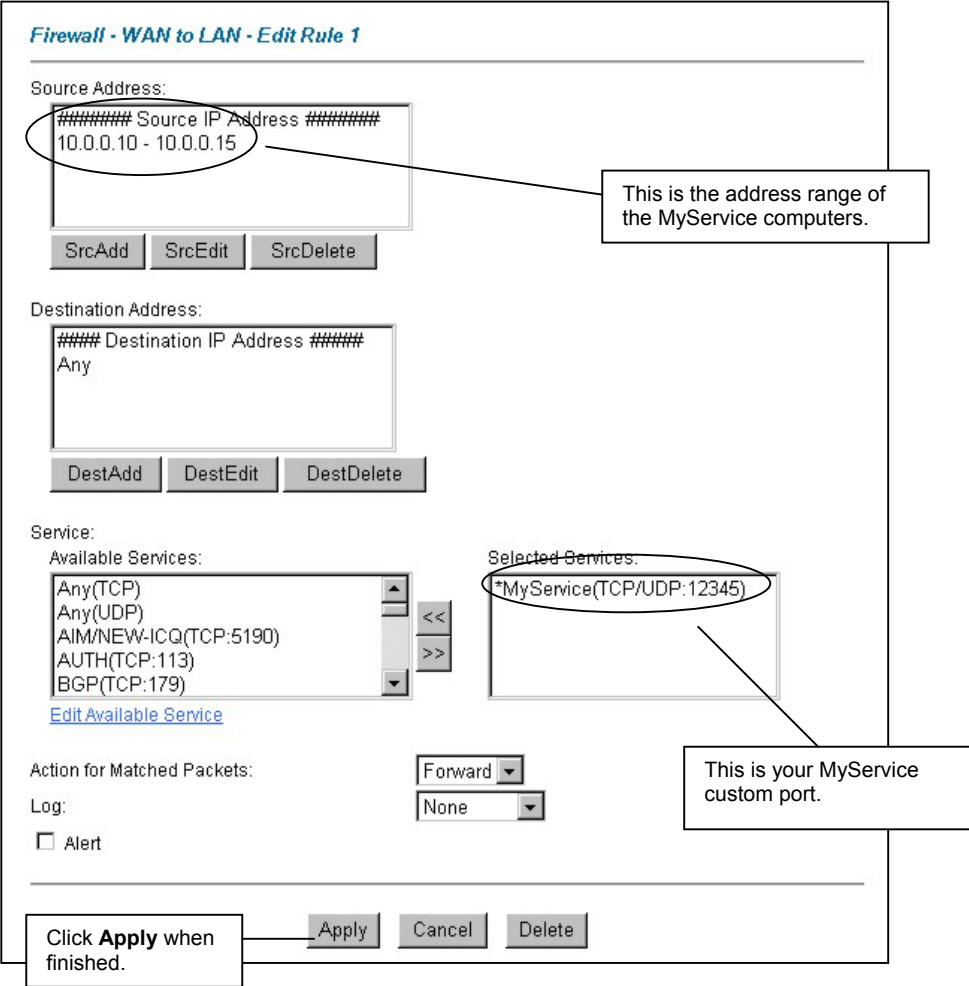

Figure 14-5 Syslog Rule Configuration Example

Step 7. On completing the configuration procedure for these Internet firewall rules, the **Rule Summary** screen should look like the following. Don't forget to click **Apply** when you have finished configuring your rule(s) to save your settings back to the Prestige.

This rule allows a MyService connection from the WAN.

Firewall - WAN to LAN - Rule Summary

The default action for packets not matching following rules:

Default Permit Log

No.	Source IP	Destination IP	Service	Action	Log
1	10.0.0.10 - 10.0.0.15	Any	*MyService(TCP/UDP:12345)	Forward	None
2					
3					
4					
5					
6					
7					
8					
9					
10					

Rules Reorder: Move rule number to rule number

Click **Apply** to save your settings back to the Prestige.

Figure 14-6 Rule Summary Example

Chapter 15

Content Filtering Screens

This chapter covers how to configure content filtering.

15.1 Content Filtering Overview

Internet content filtering allows you to create and enforce Internet access policies tailored to your needs. Content filtering gives you the ability to block web sites that contain key words (that you specify) in the URL. You can set a schedule for when the Prestige performs content filtering. You can also specify trusted IP addresses on the LAN for which the Prestige will not perform content filtering.

15.2 Configuring Keyword Blocking

Use this screen to block sites containing certain keywords in the URL. For example, if you enable the keyword "bad", the Prestige blocks all sites containing this keyword including the URL <http://www.website.com/bad.html>, even if it is not included in the Filter List.

To have your Prestige block Web sites containing keywords in their URLs, click **Content Filter** and **Keyword**. The screen appears as shown.

Figure 15-1 Content Filter: Keyword

The following table describes the fields in this screen.

Table 15-1 Content Filter: Keyword

LABEL	DESCRIPTION
Enable Keyword Blocking	Select this check box to enable this feature.
Block Websites that contain these keywords in the URL:	This box contains the list of all the keywords that you have configured the Prestige to block.
Delete	Highlight a keyword in the box and click Delete to remove it.
Clear All	Click Clear All to remove all of the keywords from the list.
Keyword	Type a keyword in this field. You may use any character (up to 64 characters). Wildcards are not allowed.

Table 15-1 Content Filter: Keyword

LABEL	DESCRIPTION
Add Keyword	Click Add Keyword after you have typed a keyword. Repeat this procedure to add other keywords. Up to 64 keywords are allowed. When you try to access a web page containing a keyword, you will get a message telling you that the content filter is blocking this request.
Back	Click Back to return to the previous screen.
Apply	Click Apply to save your changes back to the Prestige.
Cancel	Click Cancel to return to the previously saved settings.

15.3 Configuring the Schedule

To set the days and times for the Prestige to perform content filtering, click **Content Filter** and **Schedule**. The screen appears as shown.

Content Filter - Schedule

Days to Block:

Everyday
 Sun Mon Tue Wed Thu Fri Sat

Time of Day to Block: (24 Hour Format)

All day

Start: (hour) (minute) End: (hour) (minute)

Figure 15-2 Content Filter: Schedule

The following table describes the fields in this screen.

Table 15-2 Content Filter: Schedule

LABEL	DESCRIPTION
Days to Block:	Select a check box to configure which days of the week (or everyday) you want the content filtering to be active.
Time of Day to Block:	Use the 24-hour format to configure which time of the day (or select the All day check box) you want the content filtering to be active.
Back	Click Back to return to the previous screen.
Apply	Click Apply to save your changes.
Cancel	Click Cancel to return to the previously saved settings.

15.4 Configuring Trusted Computers

To exclude a range of users on the LAN from content filtering on your Prestige, click **CONTENT FILTER** and **Trusted**. The screen appears as shown.

Figure 15-3 Content Filter: Trusted

The following table describes the fields in this screen.

Table 15-3 Content Filter: Trusted

LABEL	DESCRIPTION
Trusted User IP Range	
From	Type the IP address of a computer (or the beginning IP address of a specific range of computers) on the LAN that you want to exclude from content filtering.

Table 15-3 Content Filter: Trusted

LABEL	DESCRIPTION
To	Type the ending IP address of a specific range of users on your LAN that you want to exclude from content filtering. Leave this field blank if you want to exclude an individual computer.
Back	Click Back to return to the previous screen.
Apply	Click Apply to save your changes back to the Prestige.
Cancel	Click Cancel to return to the previously saved settings.

Part V:

VPN/IPSec

This part provides information about configuring VPN/IPSec for secure communications.

Chapter 16

Introduction to IPSec

This chapter introduces the basics of IPSec VPNs.

16.1 VPN Overview

A VPN (Virtual Private Network) provides secure communications between sites without the expense of leased site-to-site lines. A secure VPN is a combination of tunneling, encryption, authentication, access control and auditing technologies/services used to transport traffic over the Internet or any insecure network that uses the TCP/IP protocol suite for communication.

16.1.1 IPSec

Internet Protocol Security (IPSec) is a standards-based VPN that offers flexible solutions for secure data communications across a public network like the Internet. IPSec is built around a number of standardized cryptographic techniques to provide confidentiality, data integrity and authentication at the IP layer.

16.1.2 Security Association

A Security Association (SA) is a contract between two parties indicating what security parameters, such as keys and algorithms they will use.

16.1.3 Other Terminology

➤ Encryption

Encryption is a mathematical operation that transforms data from "plaintext" (readable) to "ciphertext" (scrambled text) using a "key". The key and clear text are processed by the encryption operation, which leads to the data scrambling that makes encryption secure. Decryption is the opposite of encryption: it is a mathematical operation that transforms "ciphertext" to plaintext. Decryption also requires a key.

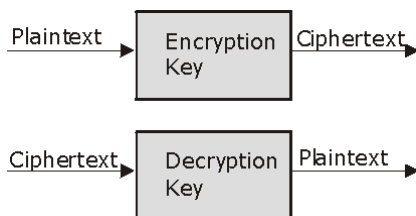

Figure 16-1 Encryption and Decryption

➤ **Data Confidentiality**

The IPSec sender can encrypt packets before transmitting them across a network.

➤ **Data Integrity**

The IPSec receiver can validate packets sent by the IPSec sender to ensure that the data has not been altered during transmission.

➤ **Data Origin Authentication**

The IPSec receiver can verify the source of IPSec packets. This service depends on the data integrity service.

16.1.4 VPN Applications

The Prestige supports the following VPN applications.

➤ **Linking Two or More Private Networks Together**

Connect branch offices and business partners over the Internet with significant cost savings and improved performance when compared to leased lines between sites.

➤ **Accessing Network Resources When NAT Is Enabled**

When NAT is enabled, remote users are not able to access hosts on the LAN unless the host is designated a public LAN server for that specific protocol. Since the VPN tunnel terminates inside the LAN, remote users will be able to access all computers that use private IP addresses on the LAN.

➤ **Unsupported IP Applications**

A VPN tunnel may be created to add support for unsupported emerging IP applications. See the section on *Getting to Know You Prestige* for an example of a VPN application.

16.2 IPsec Architecture

The overall IPsec architecture is shown as follows.

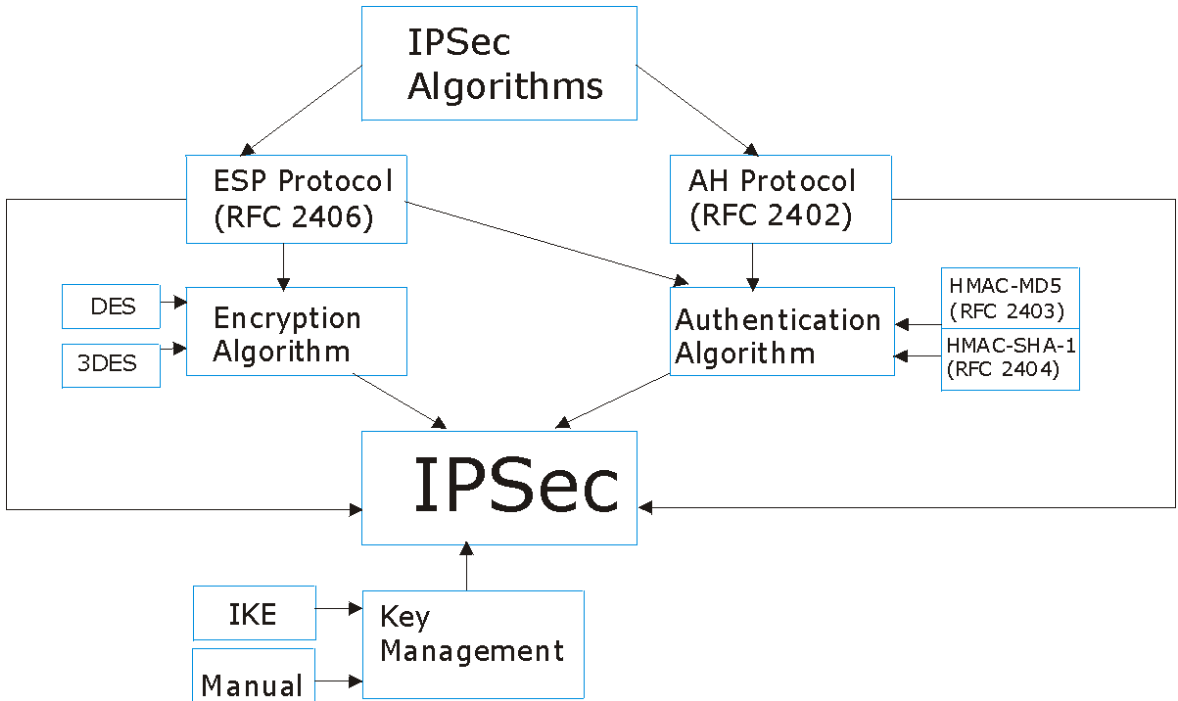

Figure 16-2 IPsec Architecture

16.2.1 IPsec Algorithms

The **ESP** (Encapsulating Security Payload) Protocol (RFC 2406) and **AH** (Authentication Header) protocol (RFC 2402) describe the packet formats and the default standards for packet structure (including implementation algorithms).

The Encryption Algorithm describes the use of encryption techniques such as DES (Data Encryption Standard) and Triple DES algorithms.

The Authentication Algorithms, HMAC-MD5 (RFC 2403) and HMAC-SHA-1 (RFC 2404), provide an authentication mechanism for the **AH** and **ESP** protocols. Please see *section 17.2* for more information.

16.2.2 Key Management

Key management allows you to determine whether to use IKE (ISAKMP) or manual key configuration in order to set up a VPN.

16.3 Encapsulation

The two modes of operation for IPSec VPNs are **Transport** mode and **Tunnel** mode.

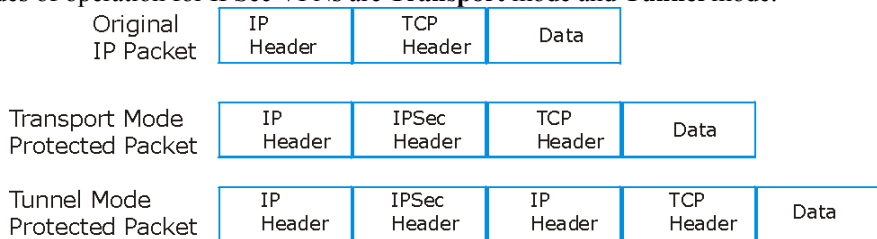

Figure 16-3 Transport and Tunnel Mode IPSec Encapsulation

16.3.1 Transport Mode

Transport mode is used to protect upper layer protocols and only affects the data in the IP packet. In **Transport** mode, the IP packet contains the security protocol (**AH** or **ESP**) located after the original IP header and options, but before any upper layer protocols contained in the packet (such as TCP and UDP). With **ESP**, protection is applied only to the upper layer protocols contained in the packet. The IP header information and options are not used in the authentication process. Therefore, the originating IP address cannot be verified for integrity against the data.

With the use of **AH** as the security protocol, protection is extended forward into the IP header to verify the integrity of the entire packet by use of portions of the original IP header in the hashing process.

16.3.2 Tunnel Mode

Tunnel mode encapsulates the entire IP packet to transmit it securely. A **Tunnel** mode is required for gateway services to provide access to internal systems. **Tunnel** mode is fundamentally an IP tunnel with authentication and encryption. This is the most common mode of operation. **Tunnel** mode is required for gateway to gateway and host to gateway communications. **Tunnel** mode communications have two sets of IP headers:

- **Outside header:** The outside IP header contains the destination IP address of the VPN gateway.
- **Inside header:** The inside IP header contains the destination IP address of the final system behind the VPN gateway. The security protocol appears after the outer IP header and before the inside IP header.

16.4 IPSec and NAT

Read this section if you are running IPSec on a host computer behind the Prestige.

NAT is incompatible with the **AH** protocol in both **Transport** and **Tunnel** mode. An IPSec VPN using the **AH** protocol digitally signs the outbound packet, both data payload and headers, with a hash value appended to the packet. When using **AH** protocol, packet contents (the data payload) are not encrypted.

A NAT device in between the IPSec endpoints will rewrite either the source or destination address with one of its own choosing. The VPN device at the receiving end will verify the integrity of the incoming packet by computing its own hash value, and complain that the hash value appended to the received packet doesn't match. The VPN device at the receiving end doesn't know about the NAT in the middle, so it assumes that the data has been maliciously altered.

IPSec using **ESP** in **Tunnel** mode encapsulates the entire original packet (including headers) in a new IP packet. The new IP packet's source address is the outbound address of the sending VPN gateway, and its destination address is the inbound address of the VPN device at the receiving end. When using **ESP** protocol with authentication, the packet contents (in this case, the entire original packet) are encrypted. The encrypted contents, but not the new headers, are signed with a hash value appended to the packet.

Tunnel mode **ESP** with authentication is compatible with NAT because integrity checks are performed over the combination of the "original header plus original payload," which is unchanged by a NAT device.

Transport mode **ESP** with authentication is not compatible with NAT

Table 16-1 VPN and NAT

SECURITY PROTOCOL	MODE	NAT
AH	Transport	N
AH	Tunnel	N
ESP	Transport	N
ESP	Tunnel	Y

Chapter 17

VPN Screens

This chapter introduces the VPN screens. See the Logs chapter for information on viewing logs and the appendices for IPsec log descriptions.

17.1 VPN/IPsec Overview

Use the screens documented in this chapter to configure rules for VPN connections and manage VPN connections.

17.2 IPsec Algorithms

The **ESP** and **AH** protocols are necessary to create a Security Association (SA), the foundation of an IPsec VPN. An SA is built from the authentication provided by the **AH** and **ESP** protocols. The primary function of key management is to establish and maintain the SA between systems. Once the SA is established, the transport of data may commence.

17.2.1 AH (Authentication Header) Protocol

AH protocol (RFC 2402) was designed for integrity, authentication, sequence integrity (replay resistance), and non-repudiation but not for confidentiality, for which the **ESP** was designed.

In applications where confidentiality is not required or not sanctioned by government encryption restrictions, an **AH** can be employed to ensure integrity. This type of implementation does not protect the information from dissemination but will allow for verification of the integrity of the information and authentication of the originator.

17.2.2 ESP (Encapsulating Security Payload) Protocol

The **ESP** protocol (RFC 2406) provides encryption as well as some of the services offered by **AH**. **ESP** authenticating properties are limited compared to the **AH** due to the non-inclusion of the IP header information during the authentication process. However, **ESP** is sufficient if only the upper layer protocols need to be authenticated.

An added feature of the **ESP** is payload padding, which further protects communications by concealing the size of the packet being transmitted.

Table 17-1 AH and ESP

ESP	AH
Select DES for minimal security and 3DES for maximum. Select NULL to set up a tunnel without encryption.	Select MD5 for minimal security and SHA-1 for maximum security.
DES (default) Data Encryption Standard (DES) is a widely used method of data encryption using a private (secret) key. DES applies a 56-bit key to each 64-bit block of data.	MD5 (default) MD5 (Message Digest 5) produces a 128-bit digest to authenticate packet data.
3DES Triple DES (3DES) is a variant of DES, which iterates three times with three separate keys (3 x 56 = 168 bits), effectively doubling the strength of DES.	SHA1 SHA1 (Secure Hash Algorithm) produces a 160-bit digest to authenticate packet data.
Select DES for minimal security and 3DES for maximum. Select NULL to set up a tunnel without encryption.	Select MD5 for minimal security and SHA-1 for maximum security.

17.3 My IP Address

My IP Address is the WAN IP address of the Prestige. If this field is configured as 0.0.0.0, then the Prestige will use the current Prestige WAN IP address (static or dynamic) to set up the VPN tunnel. The Prestige has to rebuild the VPN tunnel if the **My IP Address** changes after setup.

17.4 Secure Gateway Address

Secure Gateway Address is the WAN IP address or domain name of the remote IPSec router (secure gateway).

If the remote secure gateway has a static WAN IP address, enter it in the **Secure Gateway Address** field. You may alternatively enter the remote secure gateway's domain name (if it has one) in the **Secure Gateway Address** field.

You can also enter a remote secure gateway's domain name in the **Secure Gateway Address** field if the remote secure gateway has a dynamic WAN IP address and is using DDNS. The Prestige has to rebuild the VPN tunnel each time the remote secure gateway's WAN IP address changes (there may be a delay until the DDNS servers are updated with the remote gateway's new WAN IP address).

17.4.1 Dynamic Secure Gateway Address

If the remote secure gateway has a dynamic WAN IP address and does not use DDNS, enter 0.0.0.0 as the secure gateway's address. In this case only the remote secure gateway can initiate SAs. This may be useful

for telecommuters initiating a VPN tunnel to the company network. See *section 17.16* for configuration examples.

The Secure Gateway IP Address may be configured as 0.0.0.0 only when using IKE key management and not Manual key management.

17.5 VPN Summary Screen

The following figure helps explain the main fields in the web configurator.

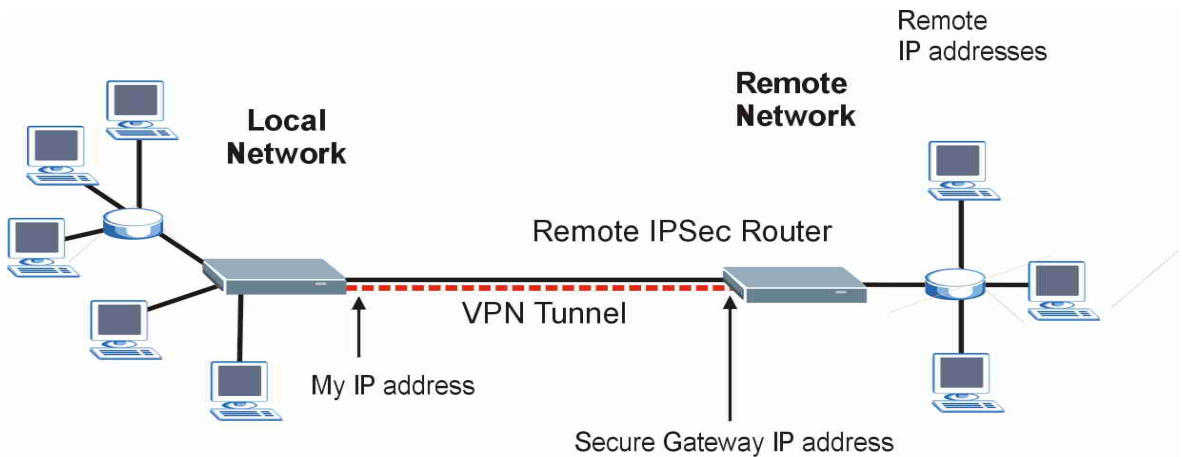

Figure 17-1 IPsec Summary Fields

Local and remote IP addresses must be static.

Click **VPN** and **Setup** to open the **VPN Summary** screen. This is a read-only menu of your IPsec rules (tunnels). The IPsec summary menu is read-only. Edit a VPN by selecting an index number and then configuring its associated submenus.

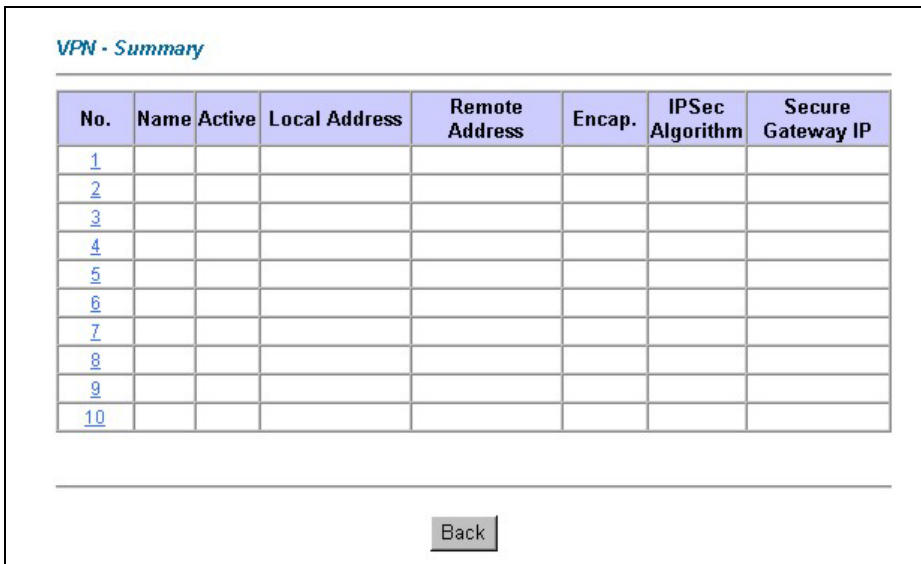

Figure 17-2 VPN Summary

The following table describes the fields in this screen.

Table 17-2 VPN Summary

LABEL	DESCRIPTION
No.	This is the VPN policy index number. Click a number to edit VPN policies.
Name	This field displays the identification name for this VPN policy.
Active	This field displays whether the VPN policy is active or not. A "Y" signifies that this VPN policy is active.
Local Address	This is the IP address(es) of computers on your local network behind your Prestige.
Remote Address	This is the IP address(es) of computers on the remote network behind the remote IPsec router.
Encap.	This field displays Tunnel or Transport mode.
IPsec Algorithm	This field displays the security protocols used for an SA. Both AH and ESP increase Prestige processing requirements and communications latency (delay).

Table 17-2 VPN Summary

LABEL	DESCRIPTION
Secure Gateway IP	This is the IP address of the remote IPSec router. This must be a fixed, public IP address for traffic going through the Internet.
Back	Click Back to return to the previous screen.

17.6 Keep Alive

When you initiate an IPSec tunnel with keep alive enabled, the Prestige automatically renegotiates the tunnel when the IPSec SA lifetime period expires (see *section 17.10* for more on the IPSec SA lifetime). In effect, the IPSec tunnel becomes an “always on” connection after you initiate it. Both IPSec routers must have a Prestige-compatible keep alive feature enabled in order for this feature to work.

If the Prestige has its maximum number of simultaneous IPSec tunnels connected to it and they all have keep alive enabled, then no other tunnels can take a turn connecting to the Prestige because the Prestige never drops the tunnels that are already connected. Check *section 1-1 Features of the Prestige* in chapter 1 to see how many simultaneous IPSec SAs your Prestige can support.

When there is outbound traffic with no inbound traffic, the Prestige automatically drops the tunnel after two minutes.

17.7 ID Type and Content

With aggressive negotiation mode (see *section 17.10.1*), the Prestige identifies incoming SAs by ID type and content since this identifying information is not encrypted. This enables the Prestige to distinguish between multiple rules for SAs that connect from remote IPSec routers that have dynamic WAN IP addresses. Telecommuters can use separate passwords to simultaneously connect to the Prestige from IPSec routers with dynamic IP addresses (see *section 17.16.2* for a telecommuter configuration example).

With main mode (see *section 17.10.1*), the ID type and content are encrypted to provide identity protection. In this case the Prestige can only distinguish between up to eight different incoming SAs that connect from remote IPSec routers that have dynamic WAN IP addresses. The Prestige can distinguish up to eight incoming SAs because you can select between two encryption algorithms (DES and 3DES), two authentication algorithms (MD5 and SHA1) and two key groups (DH1 and DH2) when you configure a VPN rule (see *section 17.11*). The ID type and content act as an extra level of identification for incoming SAs.

The type of ID can be a domain name, an IP address or an e-mail address. The content is the IP address, domain name, or e-mail address.

Table 17-3 Local ID Type and Content Fields

LOCAL ID TYPE=	CONTENT=
IP	Type the IP address of your computer or leave the field blank to have the Prestige automatically use its own IP address.
DNS	Type a domain name (up to 31 characters) by which to identify this Prestige.
E-mail	Type an e-mail address (up to 31 characters) by which to identify this Prestige.
The domain name or e-mail address that you use in the Content field is used for identification purposes only and does not need to be a real domain name or e-mail address.	

Table 17-4 Peer ID Type and Content Fields

PEER ID TYPE=	CONTENT=
IP	Type the IP address of the computer with which you will make the VPN connection or leave the field blank to have the Prestige automatically use the address in the Secure Gateway field.
DNS	Type a domain name (up to 31 characters) by which to identify the remote IPSec router.
E-mail	Type an e-mail address (up to 31 characters) by which to identify the remote IPSec router.
The domain name or e-mail address that you use in the Content field is used for identification purposes only and does not need to be a real domain name or e-mail address. The domain name also does not have to match the remote router's IP address or what you configure in the Secure Gateway Addr field below.	

17.7.1 ID Type and Content Examples

Two IPSec routers must have matching ID type and content configuration in order to set up a VPN tunnel. The two Prestiges in this example can complete negotiation and establish a VPN tunnel.

Table 17-5 Matching ID Type and Content Configuration Example

PRESTIGE A	PRESTIGE B
Local ID type: E-mail	Local ID type: IP
Local ID content: tom@yourcompany.com	Local ID content: 1.1.1.2
Peer ID type: IP	Peer ID type: E-mail
Peer ID content: 1.1.1.2	Peer ID content: tom@yourcompany.com

The two Prestiges in this example cannot complete their negotiation because Prestige B's **Local ID type** is **IP**, but Prestige A's **Peer ID type** is set to **E-mail**. An "ID mismatched" message displays in the IPSEC LOG.

Table 17-6 Mismatching ID Type and Content Configuration Example

PRESTIGE A	PRESTIGE B
Local ID type: IP	Local ID type: IP
Local ID content: 1.1.1.10	Local ID content: 1.1.1.10
Peer ID type: E-mail	Peer ID type: IP
Peer ID content: aa@yahoo.com	Peer ID content: N/A

17.8 Pre-Shared Key

A pre-shared key identifies a communicating party during a phase 1 IKE negotiation (see *section 17.10* for more on IKE phases). It is called "pre-shared" because you have to share it with another party before you can communicate with them over a secure connection.

17.9 Editing VPN Policies

Click a number (**No.**) on the **Summary** screen to edit VPN policies.

VPN - IKE

IPSec Setup

Active Keep Alive

Name

IPSec Key Mode

Negotiation Mode

Local:

LocalAddress Type

IP Address Start

End / Subnet Mask

Remote:

RemoteAddress Type

IP Address Start

End / Subnet Mask

Local ID Type

Content

My IP Address

Peer ID Type

Content

Secure Gateway IP Address

Encapsulation Mode

Security Protocol

VPN Protocol

Pre-Shared Key

VPN - Setup

Authentication Algorithm

Figure 17-3 VPN IKE

The following table describes the fields in this screen.

Table 17-7 VPN IKE

LABEL	DESCRIPTION
IPSec Setup	
Active	Select this check box to activate this VPN policy.
Keep Alive	Select either Yes or No from the drop-down list box. Select Yes to have the Prestige automatically reinitiate the SA after the SA lifetime times out, even if there is no traffic. The remote IPSec router must also have keep alive enabled in order for this feature to work.
Name	Type up to 32 characters to identify this VPN policy. You may use any character, including spaces, but the Prestige drops trailing spaces.
IPSec Key Mode	Select IKE or Manual from the drop-down list box. Manual is a useful option for troubleshooting if you have problems using IKE key management.
Negotiation Mode	Select Main or Aggressive from the drop-down list box. Multiple SAs connecting through a secure gateway must have the same negotiation mode.
Local	Local IP addresses must be static and correspond to the remote IPSec router's configured remote IP addresses. Two active SAs cannot have the local and remote IP address(es) both the same. Two active SAs can have the same local or remote IP address, but not both. You can configure multiple SAs between the same local and remote IP addresses, as long as only one is active at any time.
Local Address Type	Use the drop-down menu to choose Single , Range , or Subnet . Select Single for a single IP address. Select Range for a specific range of IP addresses. Select Subnet to specify IP addresses on a network by their subnet mask.
IP Address Start	When the Local Address Type field is configured to Single , enter a (static) IP address on the LAN behind your Prestige. When the Local Address Type field is configured to Range , enter the beginning (static) IP address, in a range of computers on your LAN behind your Prestige. When the Local Address Type field is configured to Subnet , this is a (static) IP address on the LAN behind your Prestige.

Table 17-7 VPN IKE

LABEL	DESCRIPTION
End / Subnet Mask	When the Local Address Type field is configured to Single , enter the IP address in the IP Address Start field again here. When the Local Address Type field is configured to Range , enter the end (static) IP address, in a range of computers on the LAN behind your Prestige. When the Local Address Type field is configured to Subnet , this is a subnet mask on the LAN behind your Prestige.
Remote	<p>Remote IP addresses must be static and correspond to the remote IPSec router's configured local IP addresses. The remote fields do not apply when the Secure Gateway IP Address field is configured to 0.0.0.0. In this case only the remote IPSec router can initiate the VPN.</p> <p>Two active SAs cannot have the local and remote IP address(es) both the same. Two active SAs can have the same local or remote IP address, but not both. You can configure multiple SAs between the same local and remote IP addresses, as long as only one is active at any time.</p>
Remote Address Type	Use the drop-down menu to choose Single , Range , or Subnet . Select Single with a single IP address. Select Range for a specific range of IP addresses. Select Subnet to specify IP addresses on a network by their subnet mask.
IP Address Start	When the Remote Address Type field is configured to Single , enter a (static) IP address on the network behind the remote IPSec router. When the Remote Address Type field is configured to Range , enter the beginning (static) IP address, in a range of computers on the network behind the remote IPSec router. When the Remote Address Type field is configured to Subnet , enter a (static) IP address on the network behind the remote IPSec router.
End / Subnet Mask	When the Remote Address Type field is configured to Single , enter the IP address in the IP Address Start field again here. When the Remote Address Type field is configured to Range , enter the end (static) IP address, in a range of computers on the network behind the remote IPSec router. When the Remote Address Type field is configured to Subnet , enter a subnet mask on the network behind the remote IPSec router.
Local ID Type	<p>Select IP to identify this Prestige by its IP address.</p> <p>Select DNS to identify this Prestige by a domain name.</p> <p>Select E-mail to identify this Prestige by an e-mail address.</p>

Table 17-7 VPN IKE

LABEL	DESCRIPTION
Content	<p>When you select IP in the Local ID Type field, type the IP address of your computer or leave the field blank to have the Prestige automatically use its own IP address.</p> <p>When you select DNS in the Local ID Type field, type a domain name (up to 31 characters) by which to identify this Prestige.</p> <p>When you select E-mail in the Local ID Type field, type an e-mail address (up to 31 characters) by which to identify this Prestige.</p> <p>The domain name or e-mail address that you use in the Content field is used for identification purposes only and does not need to be a real domain name or e-mail address.</p>
My IP Address	Enter the WAN IP address of your Prestige. The Prestige uses its current WAN IP address (static or dynamic) in setting up the VPN tunnel if you leave this field as 0.0.0.0. The VPN tunnel has to be rebuilt if this IP address changes.
Peer ID Type	<p>Select IP to identify the remote IPSec router by its IP address.</p> <p>Select DNS to identify the remote IPSec router by a domain name.</p> <p>Select E-mail to identify the remote IPSec router by an e-mail address.</p>
Content	<p>When you select IP in the Peer ID Type field, type the IP address of the computer with which you will make the VPN connection or leave the field blank to have the Prestige automatically use the address in the Secure Gateway IP Address field.</p> <p>When you select DNS in the Peer ID Type field, type a domain name (up to 31 characters) by which to identify the remote IPSec router.</p> <p>When you select E-mail in the Peer ID Type field, type an e-mail address (up to 31 characters) by which to identify the remote IPSec router.</p> <p>The domain name or e-mail address that you use in the Content field is used for identification purposes only and does not need to be a real domain name or e-mail address. The domain name also does not have to match the remote router's IP address or what you configure in the Secure Gateway IP Address field.</p>
Secure Gateway IP Address	Type the WAN IP address or the URL (up to 31 characters) of the IPSec router with which you're making the VPN connection. Set this field to 0.0.0.0 if the remote IPSec router has a dynamic WAN IP address (the IPSec Key Mode field must be set to IKE).
Encapsulation Mode	Select Tunnel mode or Transport mode from the drop-down list box.

Table 17-7 VPN IKE

LABEL	DESCRIPTION
Security Protocol	
VPN Protocol	Select ESP if you want to use ESP (Encapsulation Security Payload). The ESP protocol (RFC 2406) provides encryption as well as some of the services offered by AH . If you select ESP here, you must select options from the VPN Setup and Authentication Algorithm fields (described next).
Pre-Shared Key	Type your pre-shared key in this field. A pre-shared key identifies a communicating party during a phase 1 IKE negotiation. It is called "pre-shared" because you have to share it with another party before you can communicate with them over a secure connection. Multiple SAs connecting through a secure gateway must have the same pre-shared key.
VPN - Setup	Select DES , 3DES or NULL from the drop-down list box. When DES is used for data communications, both sender and receiver must know the same secret key, which can be used to encrypt and decrypt the message or to generate and verify a message authentication code. The DES encryption algorithm uses a 56-bit key. Triple DES (3DES) is a variation on DES that uses a 168-bit key. As a result, 3DES is more secure than DES. It also requires more processing power, resulting in increased latency and decreased throughput. Select NULL to set up a tunnel without encryption. When you select NULL , you do not enter an encryption key.
Authentication Algorithm	Select SHA1 or MD5 from the drop-down list box. MD5 (Message Digest 5) and SHA1 (Secure Hash Algorithm) are hash algorithms used to authenticate packet data. The SHA1 algorithm is generally considered stronger than MD5 , but is slower. Select MD5 for minimal security and SHA-1 for maximum security.
Advanced	Click Advanced to configure more detailed settings of your IKE key management.
Back	Click Back to return to the previous screen.
Apply	Click Apply to save your changes back to the Prestige.
Cancel	Click Cancel to begin configuring this screen afresh.
Delete	Click Delete to delete the current rule.

17.10 IKE Phases

There are two phases to every IKE (Internet Key Exchange) negotiation – phase 1 (Authentication) and phase 2 (Key Exchange). A phase 1 exchange establishes an IKE SA and the second one uses that SA to negotiate SAs for IPSec.

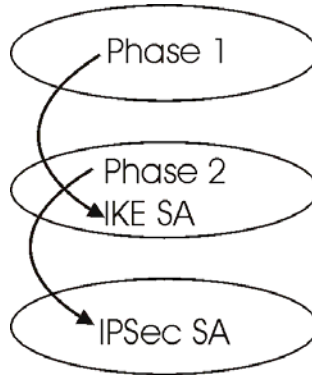

Figure 17-4 Two Phases to Set Up the IPSec SA

In phase 1 you must:

- Choose a negotiation mode.
- Authenticate the connection by entering a pre-shared key.
- Choose an encryption algorithm.
- Choose an authentication algorithm.
- Choose a Diffie-Hellman public-key cryptography key group (**DH1** or **DH2**).
- Set the IKE SA lifetime. This field allows you to determine how long an IKE SA should stay up before it times out. An IKE SA times out when the IKE SA lifetime period expires. If an IKE SA times out when an IPSec SA is already established, the IPSec SA stays connected.

In phase 2 you must:

- Choose which protocol to use (**ESP** or **AH**) for the IKE key exchange.
- Choose an encryption algorithm.
- Choose an authentication algorithm
- Choose whether to enable Perfect Forward Secrecy (PFS) using Diffie-Hellman public-key cryptography – see *section 17.10.3*. Select **None** (the default) to disable PFS.
- Choose **Tunnel** mode or **Transport** mode.
- Set the IPSec SA lifetime. This field allows you to determine how long the IPSec SA should stay up before it times out. The Prestige automatically renegotiates the IPSec SA if there is traffic when the IPSec SA lifetime period expires. The Prestige also automatically renegotiates the IPSec SA if both IPSec routers have keep alive enabled, even if there is no traffic. If an IPSec SA times out, then the IPSec router must renegotiate the SA the next time someone attempts to send traffic.

17.10.1 Negotiation Mode

The phase 1 **Negotiation Mode** you select determines how the Security Association (SA) will be established for each connection through IKE negotiations.

- **Main Mode** ensures the highest level of security when the communicating parties are negotiating authentication (phase 1). It uses 6 messages in three round trips: SA negotiation, Diffie-Hellman exchange and an exchange of nonces (a nonce is a random number). This mode features identity protection (your identity is not revealed in the negotiation).
- **Aggressive Mode** is quicker than **Main Mode** because it eliminates several steps when the communicating parties are negotiating authentication (phase 1). However the trade-off is that faster speed limits its negotiating power and it also does not provide identity protection. It is useful in remote access situations where the address of the initiator is not known by the responder and both parties want to use pre-shared key authentication.

17.10.2 Diffie-Hellman (DH) Key Groups

Diffie-Hellman (DH) is a public-key cryptography protocol that allows two parties to establish a shared secret over an unsecured communications channel. Diffie-Hellman is used within IKE SA setup to establish session keys. 768-bit (Group 1 - **DH1**) and 1024-bit (Group 2 - **DH2**) Diffie-Hellman groups are supported. Upon completion of the Diffie-Hellman exchange, the two peers have a shared secret, but the IKE SA is not authenticated. For authentication, use pre-shared keys.

17.10.3 Perfect Forward Secrecy (PFS)

Enabling PFS means that the key is transient. The key is thrown away and replaced by a brand new key using a new Diffie-Hellman exchange for each new IPsec SA setup. With PFS enabled, if one key is compromised, previous and subsequent keys are not compromised, because subsequent keys are not derived from previous keys. The (time-consuming) Diffie-Hellman exchange is the trade-off for this extra security.

This may be unnecessary for data that does not require such security, so PFS is disabled (**None**) by default in the Prestige. Disabling PFS means new authentication and encryption keys are derived from the same root secret (which may have security implications in the long run) but allows faster SA setup (by bypassing the Diffie-Hellman key exchange).

17.11 Configuring Advanced IKE Settings

Click **Advanced** in the **VPN IKE** screen. This is the **VPN IKE- Advanced** screen as shown next.

VPN - IKE - Advanced Setup

VPN - IKE

Protocol

Enable Replay Detection

LocalStart Port End

RemoteStart Port End

Phase1

Negotiation Mode

Pre-Shared Key

Encryption Algorithm

Authentication Algorithm

SA Life Time (Seconds)

Key Group

Phase2

Active Protocol

Encryption Algorithm

Authentication Algorithm

SA Life Time (Seconds)

Encapsulation

Perfect Forward Secrecy(PFS)

Figure 17-5 VPN IKE: Advanced

The following table describes the fields in this screen.

Table 17-8 VPN IKE: Advanced

LABEL	DESCRIPTION
VPN - IKE	
Protocol	Enter 1 for ICMP, 6 for TCP, 17 for UDP, etc. 0 is the default and signifies any protocol.

Table 17-8 VPN IKE: Advanced

LABEL	DESCRIPTION
Enable Replay Protection	As a VPN setup is processing intensive, the system is vulnerable to Denial of Service (DoS) attacks. The IPSec receiver can detect and reject old or duplicate packets to protect against replay attacks. Select YES from the drop-down menu to enable replay detection, or select NO to disable it.
Local Start Port	0 is the default and signifies any port. Type a port number from 0 to 65535. Some of the most common IP ports are: 21, FTP; 53, DNS; 23, Telnet; 80, HTTP; 25, SMTP; 110, POP3.
End	Enter a port number in this field to define a port range. This port number must be greater than that specified in the previous field. If Local Start Port is left at 0, End will also remain at 0.
Remote Start Port	0 is the default and signifies any port. Type a port number from 0 to 65535. Some of the most common IP ports are: 21, FTP; 53, DNS; 23, Telnet; 80, HTTP; 25, SMTP; 110, POP3.
End	Enter a port number in this field to define a port range. This port number must be greater than that specified in the previous field. If Remote Start Port is left at 0, End will also remain at 0.
Phase 1	
Negotiation Mode	Select Main or Aggressive from the drop-down list box. Multiple SAs connecting through a secure gateway must have the same negotiation mode.
Pre-Shared Key	<p>Type your pre-shared key in this field. A pre-shared key identifies a communicating party during a phase 1 IKE negotiation. It is called "pre-shared" because you have to share it with another party before you can communicate with them over a secure connection.</p> <p>Type from 8 to 31 case-sensitive ASCII characters or from 16 to 62 hexadecimal ("0-9", "A-F") characters. You must precede a hexadecimal key with a "0x" (zero x), which is not counted as part of the 16 to 62-character range for the key. For example, in "0x0123456789ABCDEF", "0x" denotes that the key is hexadecimal and "0123456789ABCDEF" is the key itself.</p> <p>Both ends of the VPN tunnel must use the same pre-shared key. You will receive a "PYLD_MALFORMED" (payload malformed) packet if the same pre-shared key is not used on both ends.</p>

Table 17-8 VPN IKE: Advanced

LABEL	DESCRIPTION
Encryption Algorithm	<p>Select DES or 3DES from the drop-down list box.</p> <p>When DES is used for data communications, both sender and receiver must know the same secret key, which can be used to encrypt and decrypt the message or to generate and verify a message authentication code. The DES encryption algorithm uses a 56-bit key. Triple DES (3DES) is a variation on DES that uses a 168-bit key. As a result, 3DES is more secure than DES. It also requires more processing power, resulting in increased latency and decreased throughput.</p>
Authentication Algorithm	<p>Select SHA1 or MD5 from the drop-down list box. MD5 (Message Digest 5) and SHA1 (Secure Hash Algorithm) are hash algorithms used to authenticate packet data. The SHA1 algorithm is generally considered stronger than MD5, but is slower. Select MD5 for minimal security and SHA-1 for maximum security.</p>
SA Life Time (Seconds)	<p>Define the length of time before an IKE SA automatically renegotiates in this field. It may range from 60 to 3,000,000 seconds (almost 35 days).</p> <p>A short SA Life Time increases security by forcing the two VPN gateways to update the encryption and authentication keys. However, every time the VPN tunnel renegotiates, all users accessing remote resources are temporarily disconnected.</p>
Key Group	<p>You must choose a key group for phase 1 IKE setup. DH1 (default) refers to Diffie-Hellman Group 1 a 768 bit random number. DH2 refers to Diffie-Hellman Group 2 a 1024 bit (1Kb) random number.</p>
Phase 2	
Active Protocol	<p>Use the drop-down list box to choose from ESP or AH.</p>
Encryption Algorithm	<p>Select DES, 3DES or NULL from the drop-down list box.</p> <p>When DES is used for data communications, both sender and receiver must know the same secret key, which can be used to encrypt and decrypt the message or to generate and verify a message authentication code. The DES encryption algorithm uses a 56-bit key. Triple DES (3DES) is a variation on DES that uses a 168-bit key. As a result, 3DES is more secure than DES. It also requires more processing power, resulting in increased latency and decreased throughput. Select NULL to set up a tunnel without encryption. When you select NULL, you do not enter an encryption key.</p>

Table 17-8 VPN IKE: Advanced

LABEL	DESCRIPTION
Authentication Algorithm	Select SHA1 or MD5 from the drop-down list box. MD5 (Message Digest 5) and SHA1 (Secure Hash Algorithm) are hash algorithms used to authenticate packet data. The SHA1 algorithm is generally considered stronger than MD5, but is slower. Select MD5 for minimal security and SHA-1 for maximum security.
SA Life Time (Seconds)	Define the length of time before an IKE SA automatically renegotiates in this field. It may range from 60 to 3,000,000 seconds (almost 35 days). A short SA Life Time increases security by forcing the two VPN gateways to update the encryption and authentication keys. However, every time the VPN tunnel renegotiates, all users accessing remote resources are temporarily disconnected.
Encapsulation	Select Tunnel mode or Transport mode from the drop-down list box.
Perfect Forward Secrecy (PFS)	Perfect Forward Secrecy (PFS) is disabled (NONE) by default in phase 2 IPsec SA setup. This allows faster IPsec setup, but is not so secure. Choose DH1 or DH2 from the drop-down list box to enable PFS. DH1 refers to Diffie-Hellman Group 1 a 768 bit random number. DH2 refers to Diffie-Hellman Group 2 a 1024 bit (1Kb) random number (more secure, yet slower).
Apply	Click Apply to save your changes back to the Prestige and return to the VPN IKE screen.
Cancel	Click Cancel to return to the VPN IKE screen without saving your changes.

17.12 Manual Key Setup

Manual key management is useful if you have problems with **IKE** key management.

17.12.1 Security Parameter Index (SPI)

An SPI is used to distinguish different SAs terminating at the same destination and using the same IPsec protocol. This data allows for the multiplexing of SAs to a single gateway. The **SPI** (Security Parameter Index) along with a destination IP address uniquely identify a particular Security Association (SA). The **SPI** is transmitted from the remote VPN gateway to the local VPN gateway. The local VPN gateway then uses the network, encryption and key values that the administrator associated with the SPI to establish the tunnel.

Current ZyXEL implementation assumes identical outgoing and incoming SPIs.

17.13 Configuring Manual Key

You only configure **VPN Manual Key** when you select **Manual** in the **Key Management** field on the **VPN IKE** screen. This is the **VPN Manual Key** screen as shown next.

VPN - Manual Key

IPSec Setup

Active

Name

IPSec Key Mode

Local Address Type

IP Address Start

End / Subnet Mask

Remote Address Type

IP Address Start

End / Subnet Mask

My IP Address

Secure Gateway IP Address

SPI

Encapsulation Mode

Security Protocol

IPSec Protocol

Encapsulation Algorithm

Encapsulation Key

Authentication Algorithm

Authentication Key

Figure 17-6 Manual Setup

The following table describes the fields in this screen.

Table 17-9 VPN Manual Setup

LABEL	DESCRIPTION
Active	Select this check box to activate this VPN policy.
Name	Type up to 32 characters to identify this VPN policy. You may use any character, including spaces, but the Prestige drops trailing spaces.
IPSec Key Mode	Select IKE or Manual from the drop-down list box. Manual is a useful option for troubleshooting if you have problems using IKE key management.
Local	<p>Local IP addresses must be static and correspond to the remote IPSec router's configured remote IP addresses.</p> <p>Two active SAs cannot have the local and remote IP address(es) both the same. Two active SAs can have the same local or remote IP address, but not both. You can configure multiple SAs between the same local and remote IP addresses, as long as only one is active at any time.</p>
Local Address Type	Use the drop-down menu to choose Single , Range , or Subnet . Select Single for a single IP address. Select Range for a specific range of IP addresses. Select Subnet to specify IP addresses on a network by their subnet mask.
IP Address Start	When the Local Address Type field is configured to Single , enter a (static) IP address on the LAN behind your Prestige. When the Local Address Type field is configured to Range , enter the beginning (static) IP address, in a range of computers on your LAN behind your Prestige. When the Local Address Type field is configured to Subnet , this is a (static) IP address on the LAN behind your Prestige.
End / Subnet Mask	When the Local Address Type field is configured to Single , enter the IP address in the IP Address Start field again here. When the Local Address Type field is configured to Range , enter the end (static) IP address, in a range of computers on the LAN behind your Prestige. When the Local Address Type field is configured to Subnet , this is a subnet mask on the LAN behind your Prestige.
Remote	<p>Remote IP addresses must be static and correspond to the remote IPSec router's configured local IP addresses. The remote fields do not apply when the Secure Gateway IP Address field is configured to 0.0.0.0. In this case only the remote IPSec router can initiate the VPN.</p> <p>Two active SAs cannot have the local and remote IP address(es) both the same. Two active SAs can have the same local or remote IP address, but not both. You can configure multiple SAs between the same local and remote IP addresses, as long as only one is active at any time.</p>

Table 17-9 VPN Manual Setup

LABEL	DESCRIPTION
Remote Address Type	Use the drop-down menu to choose Single , Range , or Subnet . Select Single with a single IP address. Select Range for a specific range of IP addresses. Select Subnet to specify IP addresses on a network by their subnet mask.
IP Address Start	When the Remote Address Type field is configured to Single , enter a (static) IP address on the network behind the remote IPSec router. When the Remote Address Type field is configured to Range , enter the beginning (static) IP address, in a range of computers on the network behind the remote IPSec router. When the Remote Address Type field is configured to Subnet , enter a (static) IP address on the network behind the remote IPSec router.
End / Subnet Mask	When the Remote Address Type field is configured to Single , enter the IP address in the IP Address Start field again here. When the Remote Address Type field is configured to Range , enter the end (static) IP address, in a range of computers on the network behind the remote IPSec router. When the Remote Address Type field is configured to Subnet , enter a subnet mask on the network behind the remote IPSec router.
My IP Address	Enter the WAN IP address of your Prestige. The Prestige uses its current WAN IP address (static or dynamic) in setting up the VPN tunnel if you leave this field as 0.0.0.0 . The VPN tunnel has to be rebuilt if this IP address changes.
Secure Gateway IP Address	Type the WAN IP address or the URL (up to 31 characters) of the IPSec router with which you're making the VPN connection. Set this field to 0.0.0.0 if the remote IPSec router has a dynamic WAN IP address (the IPSec Key Mode field must be set to IKE).
SPI	Type a unique SPI from one to four characters long. Valid Characters are "0, 1, 2, 3, 4, 5, 6, 7, 8, and 9".
Encapsulation Mode	Select Tunnel mode or Transport mode from the drop-down list box.
IPSec Protocol	Select ESP if you want to use ESP (Encapsulation Security Payload). The ESP protocol (RFC 2406) provides encryption as well as some of the services offered by AH . If you select ESP here, you must select options from the Authentication Algorithm field (described later).

Table 17-9 VPN Manual Setup

LABEL	DESCRIPTION
Encapsulation Algorithm	Select DES , 3DES or NULL from the drop-down list box. When DES is used for data communications, both sender and receiver must know the same secret key, which can be used to encrypt and decrypt the message or to generate and verify a message authentication code. The DES encryption algorithm uses a 56-bit key. Triple DES (3DES) is a variation on DES that uses a 168-bit key. As a result, 3DES is more secure than DES. It also requires more processing power, resulting in increased latency and decreased throughput. Select NULL to set up a tunnel without encryption. When you select NULL , you do not enter an encryption key.
Encapsulation Key (only with ESP)	With DES , type a unique key 8 characters long. With 3DES , type a unique key 24 characters long. Any characters may be used, including spaces, but trailing spaces are truncated.
Authentication Algorithm	Select SHA1 or MD5 from the drop-down list box. MD5 (Message Digest 5) and SHA1 (Secure Hash Algorithm) are hash algorithms used to authenticate packet data. The SHA1 algorithm is generally considered stronger than MD5, but is slower. Select MD5 for minimal security and SHA-1 for maximum security.
Authentication Key	Type a unique authentication key to be used by IPsec if applicable. Enter 16 characters for MD5 authentication or 20 characters for SHA-1 authentication. Any characters may be used, including spaces, but trailing spaces are truncated.
Back	Click Back to return to the previous screen.
Apply	Click Apply to save your changes back to the Prestige.
Cancel	Click Cancel to begin configuring this screen afresh.
Delete	Click Delete to remove the current rule.

17.14 Viewing SA Monitor

Click **VPN** and **Monitor** to open the **SA Monitor** screen as shown. Use this screen to display and manage active VPN connections.

A Security Association (SA) is the group of security settings related to a specific VPN tunnel. This screen displays active VPN connections. Use **Refresh** to display active VPN connections. This screen is read-only. The following table describes the fields in this tab.

When there is outbound traffic but no inbound traffic, the SA times out automatically after two minutes. A tunnel with no outbound or inbound traffic is "idle" and does not timeout until the SA lifetime period expires. See section 17.6 on keep alive to have the Prestige renegotiate an IPsec SA when the SA lifetime expires, even if there is no traffic.

VPN - SA Monitor

No.	Name	Encapsulation	IP Sec Algorithm	Disconnect
1	-	-	-	<input type="radio"/>
2	-	-	-	<input type="radio"/>
3	-	-	-	<input type="radio"/>
4	-	-	-	<input type="radio"/>
5	-	-	-	<input type="radio"/>

Back Apply Refresh

Figure 17-7 SA Monitor

The following table describes the fields in this screen.

Table 17-10 SA Monitor

LABEL	DESCRIPTION
No	This is the security association index number.
Name	This field displays the identification name for this VPN policy.
Encapsulation	This field displays Tunnel or Transport mode.
IPSec Algorithm	This field displays the security protocols used for an SA. Both AH and ESP increase Prestige processing requirements and communications latency (delay).
Disconnect	Select Disconnect next to a security association and then click Apply to stop that security association.
Back	Click Back to return to the previous screen.
Apply	Click Apply to save your changes back to the Prestige.

Table 17-10 SA Monitor

LABEL	DESCRIPTION
Refresh	Click Refresh to display the current active VPN connection(s).

17.15 Configuring Global Setting

To change your Prestige's global settings, click **VPN** and then **Global Setting**. The screen appears as shown.

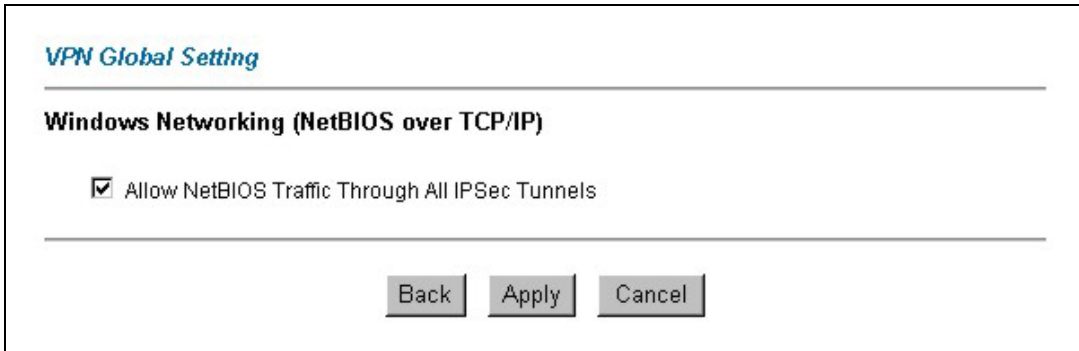

Figure 17-8 Global Setting

The following table describes the fields in this screen.

Table 17-11 Global Setting

LABEL	DESCRIPTION
Windows Networking (NetBIOS over TCP/IP)	NetBIOS (Network Basic Input/Output System) are TCP or UDP broadcast packets that enable a computer to find other computers. It may sometimes be necessary to allow NetBIOS packets to pass through VPN tunnels in order to allow local computers to find computers on the remote network and vice versa.
Allow NetBIOS Traffic Through All IP/Sec Tunnels	Select this check box to send NetBIOS packets through the VPN connection.
Back	Click Back to return to the previous screen.
Apply	Click Apply to save your changes back to the Prestige.
Cancel	Click Cancel to begin configuring this screen afresh.

17.16 Telecommuter VPN/IPSec Examples

The following examples show how multiple telecommuters can make VPN connections to a single Prestige at headquarters from remote IPSec routers that use dynamic WAN IP addresses.

17.16.1 Telecommuters Sharing One VPN Rule Example

Multiple telecommuters can use one VPN rule to simultaneously access a Prestige at headquarters. They must all use the same IPSec parameters (including the pre-shared key) but the local IP addresses (or ranges of addresses) cannot overlap. See the following table and figure for an example.

Having everyone use the same pre-shared key may create a vulnerability. If the pre-shared key is compromised, all of the VPN connections using that VPN rule are at risk. A recommended alternative is to use a different VPN rule for each telecommuter and identify them by unique IDs (see *section 17.16.2* for an example)

Table 17-12 Telecommuter and Headquarters Configuration Example

	TELECOMMUTER	HEADQUARTERS
My IP Address:	0.0.0.0 (dynamic IP address assigned by the ISP)	Public static IP address
Secure Gateway IP Address:	Public static IP address or domain name.	0.0.0.0 With this IP address only the telecommuter can initiate the IPSec tunnel.

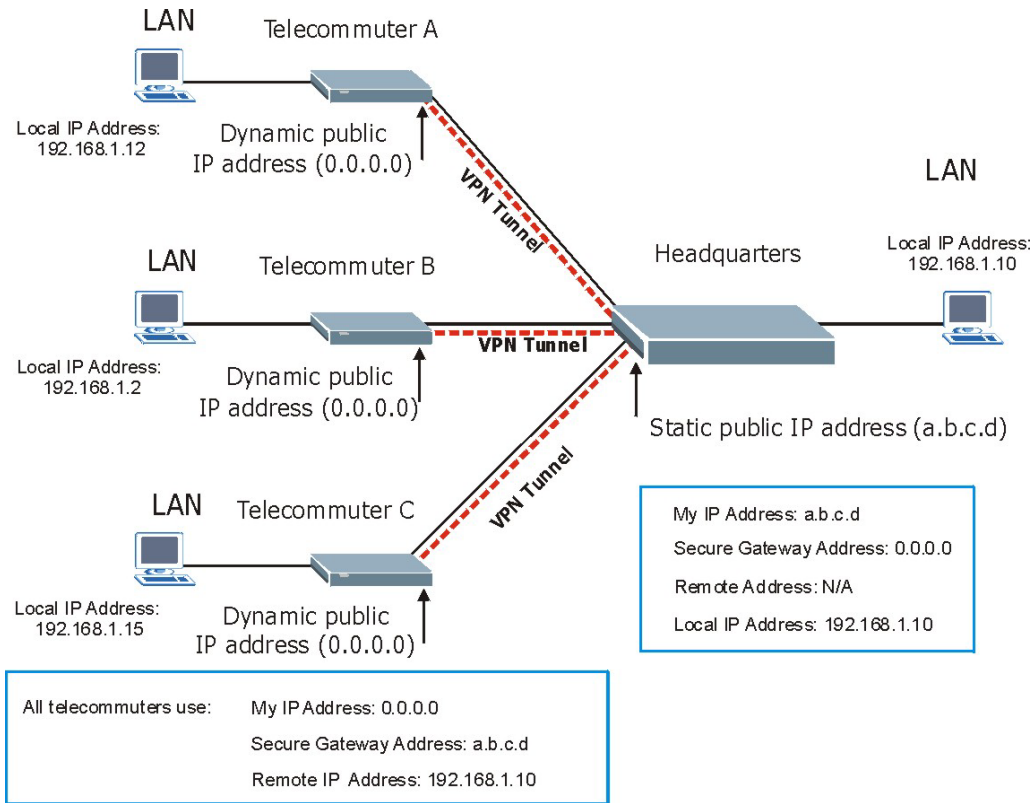

Figure 17-9 Telecommuters Sharing One VPN Rule Example

17.16.2 Telecommuters Using Unique VPN Rules Example

With aggressive negotiation mode (see *section 17.10.1*), the Prestige can use the ID types and contents to distinguish between VPN rules. Telecommuters can each use a separate VPN rule to simultaneously access a Prestige at headquarters. They can use different IPSec parameters (including the pre-shared key) and the local IP addresses (or ranges of addresses) can overlap.

See the following graphic for an example where three telecommuters each use a different VPN rule to initiate a VPN connection to a Prestige located at headquarters. The Prestige at headquarters identifies each by its secure gateway address (a dynamic domain name) and uses the appropriate VPN rule to establish the VPN connection.

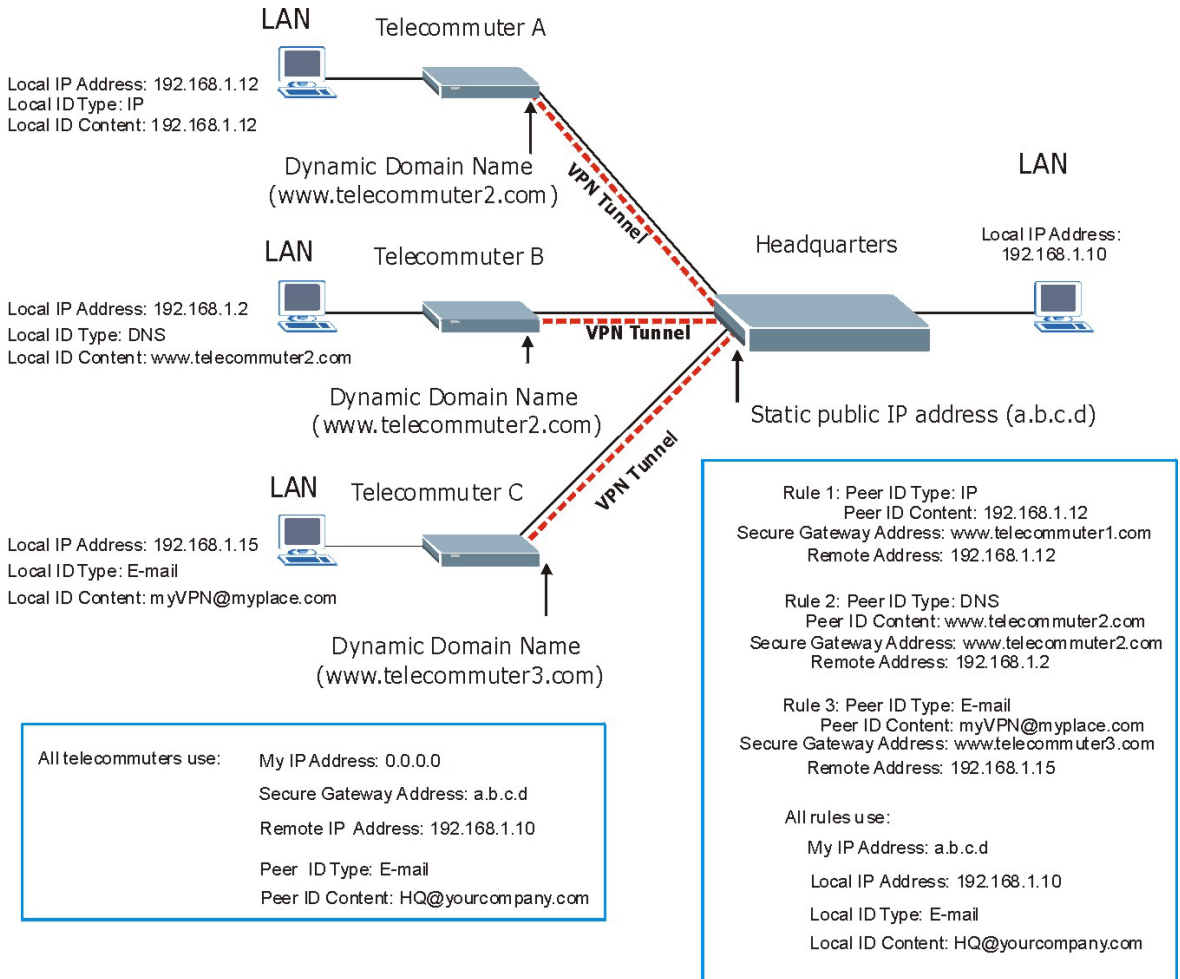

Figure 17-10 Telecommuters Using Unique VPN Rules Example

17.17 VPN and Remote Management

If a VPN tunnel uses a remote management service port (Telnet, FTP, WWW, SNMP, DNS or ICMP) and terminates at the Prestige's LAN or WAN port, configure remote management to allow access for that service.

If the VPN tunnel terminates at the Prestige's LAN IP address, configure remote management for **LAN** or **WAN** server access (or **LAN & WAN** or **LAN & WAN & DMZ**).

If the VPN tunnel terminates at the Prestige's WAN IP address, configure remote management for **WAN** server access (or **LAN & WAN** or **LAN & WAN & DMZ**).

Part VI:

Remote Management, UPnP and Logs

This part contains information on how to configure the Prestige for remote management, setting up Universal Plug and Play (UPnP) and setting up and displaying logs.

Chapter 18

Remote Management Configuration

This chapter provides information on configuring remote management.

18.1 Remote Management Overview

Remote management allows you to determine which services/protocols can access which Prestige interface (if any) from which computers.

When you configure remote management to allow management from the WAN, you still need to configure a firewall rule to allow access. See the firewall chapters for details on configuring firewall rules.

You may manage your Prestige from a remote location via:

- Internet (WAN only)
- ALL (LAN and WAN)
- LAN only,
- Neither (Disable).

When you Choose WAN only or ALL (LAN & WAN), you still need to configure a firewall rule to allow access.

To disable remote management of a service, select **Disable** in the corresponding **Server Access** field.

18.1.1 Remote Management Limitations

Remote management over LAN or WAN will not work when:

1. A filter in SMT menu 3.1 (LAN) or in menu 11.5 (WAN) is applied to block a Telnet, FTP or Web service.
2. You have disabled that service in one of the remote management screens.
3. The IP address in the **Secured Client IP** field does not match the client IP address. If it does not match, the Prestige will disconnect the session immediately.
4. There is an SMT console session running.
5. There is already another remote management session of the same type (web, FTP or Telnet) running. You may only have one remote management session of the same type running at one time.

6. There is a web remote management session running with a Telnet session. A web session will be disconnected if you begin a Telnet session; it will not begin if there already is a Telnet session.
7. There is a firewall rule that blocks it.

18.1.2 Remote Management and NAT

When NAT is enabled:

- Use the Prestige's WAN IP address when configuring from the WAN.
- Use the Prestige's LAN IP address when configuring from the LAN.

18.1.3 System Timeout

There is a system timeout of five minutes (three hundred seconds) for either the console port or telnet/web/FTP connections. Your Prestige automatically logs you out if you do nothing in this timeout period, except when it is continuously updating the status in menu 24.1 or when `sys stdio` has been changed on the command line.

18.2 Telnet

You can configure your Prestige for remote Telnet access as shown next.

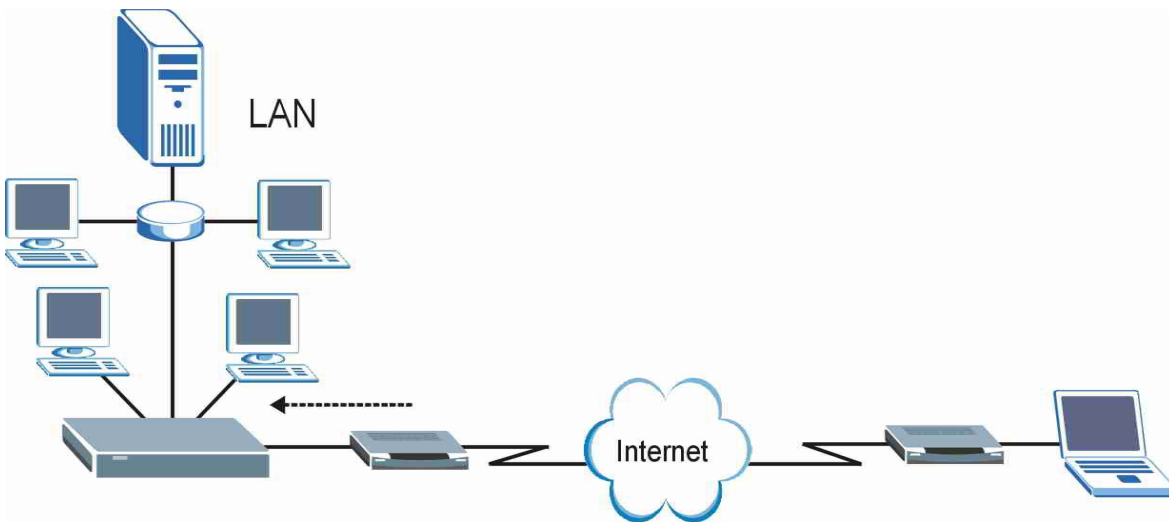

Figure 18-1 Telnet Configuration on a TCP/IP Network

18.3 FTP

You can upload and download Prestige firmware and configuration files using FTP. To use this feature, your computer must have an FTP client.

18.4 Web

You can use the Prestige's embedded web configurator for configuration and file management. See the online help for details.

18.5 Configuring Remote Management

Click **Remote Management** to open the following screen.

Remote Management Control

Server Type	Access Status	Port	Secured Client IP
Telnet	All	23	0.0.0.0
FTP	All	21	0.0.0.0
Web	All	80	0.0.0.0

Apply Cancel

Figure 18-2 Remote Management

The following table describes the fields in this screen.

Table 18-1 Remote Management

LABEL	DESCRIPTION
Server Type	Each of these labels denotes a service that you may use to remotely manage the Prestige.
Access Status	Select the access interface. Choices are All , LAN Only , WAN Only and Disable .
Port	This field shows the port number for the remote management service. You may change the port number for a service in this field, but you must use the same port number to use that service for remote management.

Table 18-1 Remote Management

LABEL	DESCRIPTION
Secured Client IP	The default 0.0.0.0 allows any client to use this service to remotely manage the Prestige. Type an IP address to restrict access to a client with a matching IP address.
Apply	Click Apply to save your settings back to the Prestige.
Cancel	Click Cancel to begin configuring this screen afresh.

Chapter 19

Universal Plug-and-Play (UPnP)

This chapter introduces the UPnP feature in the web configurator.

19.1 Introducing Universal Plug and Play

Universal Plug and Play (UPnP) is a distributed, open networking standard that uses TCP/IP for simple peer-to-peer network connectivity between devices. A UPnP device can dynamically join a network, obtain an IP address, convey its capabilities and learn about other devices on the network. In turn, a device can leave a network smoothly and automatically when it is no longer in use.

19.1.1 How do I know if I'm using UPnP?

UPnP hardware is identified as an icon in the Network Connections folder (Windows XP). Each UPnP compatible device installed on your network will appear as a separate icon. Selecting the icon of a UPnP device will allow you to access the information and properties of that device.

19.1.2 NAT Traversal

UPnP NAT traversal automates the process of allowing an application to operate through NAT. UPnP network devices can automatically configure network addressing, announce their presence in the network to other UPnP devices and enable exchange of simple product and service descriptions. NAT traversal allows the following:

- Dynamic port mapping
- Learning public IP addresses
- Assigning lease times to mappings

Windows Messenger is an example of an application that supports NAT traversal and UPnP.

See the *Network Address Translation (NAT)* chapter for further information about NAT.

19.1.3 Cautions with UPnP

The automated nature of NAT traversal applications in establishing their own services and opening firewall ports may present network security issues. Network information and configuration may also be obtained and modified by users in some network environments.

All UPnP-enabled devices may communicate freely with each other without additional configuration. Disable UPnP if this is not your intention.

19.2 UPnP and ZyXEL

ZyXEL has achieved UPnP certification from the Universal Plug and Play Forum Creates UPnP™ Implementers Corp. (UIC). ZyXEL's UPnP implementation supports IGD 1.0 (Internet Gateway Device). At the time of writing ZyXEL's UPnP implementation supports Windows Messenger 4.6 and 4.7 while Windows Messenger 5.0 and Xbox are still being tested.

UPnP broadcasts are only allowed on the LAN.

See later sections for examples of installing UPnP in Windows XP and Windows Me as well as an example of using UPnP in Windows.

19.2.1 Configuring UPnP

From the **Site Map** in the main menu, click **UPnP** under **Advanced Setup** to display the screen shown next.

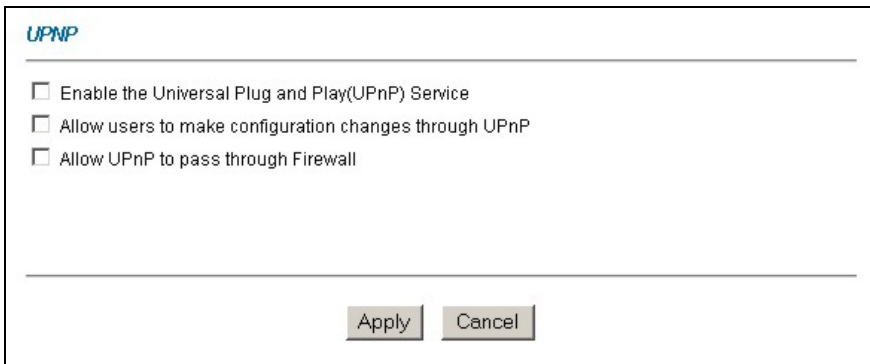

Figure 19-1 Configuring UPnP

The following table describes the fields in this screen.

Table 19-1 Configuring UPnP

LABEL	DESCRIPTION
Enable the Universal Plug and Play (UPnP) Service	Select this checkbox to activate UPnP. Be aware that anyone could use a UPnP application to open the web configurator's login screen without entering the Prestige's IP address (although you must still enter the password to access the web configurator).

Table 19-1 Configuring UPnP

LABEL	DESCRIPTION
Allow users to make configuration changes through UPnP	Select this check box to allow UPnP-enabled applications to automatically configure the Prestige so that they can communicate through the Prestige, for example by using NAT traversal. UPnP applications automatically reserve a NAT forwarding port in order to communicate with another UPnP enabled device; this eliminates the need to manually configure port forwarding for the UPnP enabled application.
Allow UPnP to pass through Firewall	Select this check box to allow traffic from UPnP-enabled applications to bypass the firewall. Clear this check box to have the firewall block all UPnP application packets (for example, MSN packets).
Apply	Click Apply to save the setting to the Prestige.
Cancel	Click Cancel to return to the previously saved settings.

19.3 Installing UPnP in Windows Example

This section shows how to install UPnP in Windows Me and Windows XP.

Installing UPnP in Windows Me

Follow the steps below to install the UPnP in Windows Me.

Step 1. Click **Start** and **Control Panel**. Double-click **Add/Remove Programs**.

Step 2. Click on the **Windows Setup** tab and select **Communication** in the **Components** selection box. Click **Details**.

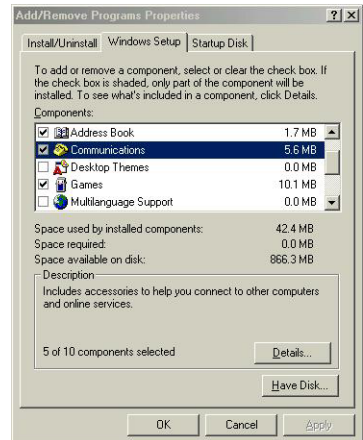

- Step 3.** In the **Communications** window, select the **Universal Plug and Play** check box in the **Components** selection box.
- Step 4.** Click **OK** to go back to the **Add/Remove Programs Properties** window and click **Next**.
- Step 5.** Restart the computer when prompted.

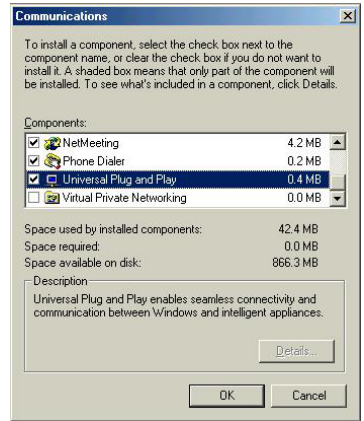

Installing UPnP in Windows XP

Follow the steps below to install the UPnP in Windows XP.

- Step 1.** Click start and Control Panel.
- Step 2.** Double-click **Network Connections**.
- Step 3.** In the **Network Connections** window, click **Advanced** in the main menu and select **Optional Networking Components**
The **Windows Optional Networking Components Wizard** window displays.
- Step 4.** Select **Networking Service** in the **Components** selection box and click **Details**.

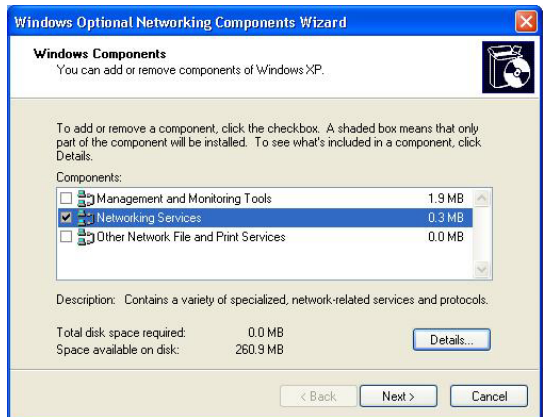
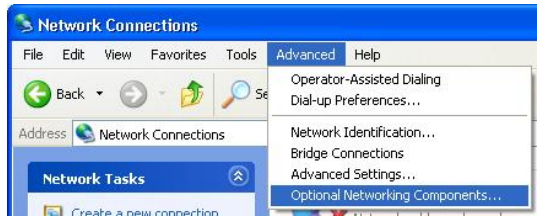

- Step 5.** In the **Networking Services** window, select the **Universal Plug and Play** check box.
- Step 6.** Click **OK** to go back to the **Windows Optional Networking Component Wizard** window and click **Next**.

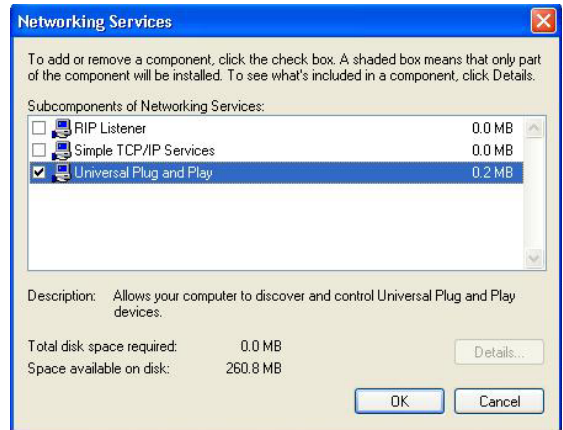

19.4 Using UPnP in Windows XP Example

This section shows you how to use the UPnP feature in Windows XP. You must already have UPnP installed in Windows XP and UPnP activated on the Prestige.

Make sure the computer is connected to a LAN port of the Prestige. Turn on your computer and the Prestige.

Auto-discover Your UPnP-enabled Network Device

- Step 1.** Click **start** and **Control Panel**. Double-click **Network Connections**. An icon displays under Internet Gateway.
- Step 2.** Right-click the icon and select **Properties**.



Step 3. In the **Internet Connection Properties** window, click **Settings** to see the port mappings there were automatically created.



Step 4. You may edit or delete the port mappings or click **Add** to manually add port mappings.

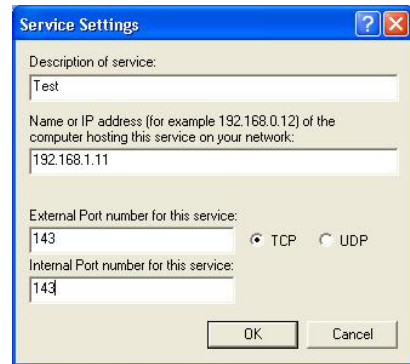
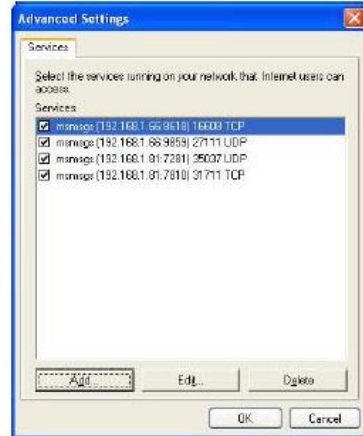

When the UPnP-enabled device is disconnected from your computer, all port mappings will be deleted automatically.

Step 5. Select **Show icon in notification area when connected** option and click **OK**. An icon displays in the system tray

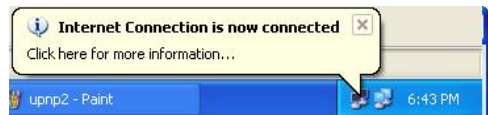

- Step 6.** Double-click on the icon to display your current Internet connection status.



Web Configurator Easy Access

With UPnP, you can access the web-based configurator on the Prestige without finding out the IP address of the Prestige first. This comes helpful if you do not know the IP address of the Prestige.

Follow the steps below to access the web configurator.

- Step 1.** Click **start** and then **Control Panel**.
- Step 2.** Double-click **Network Connections**.
- Step 3.** Select **My Network Places** under **Other Places**.

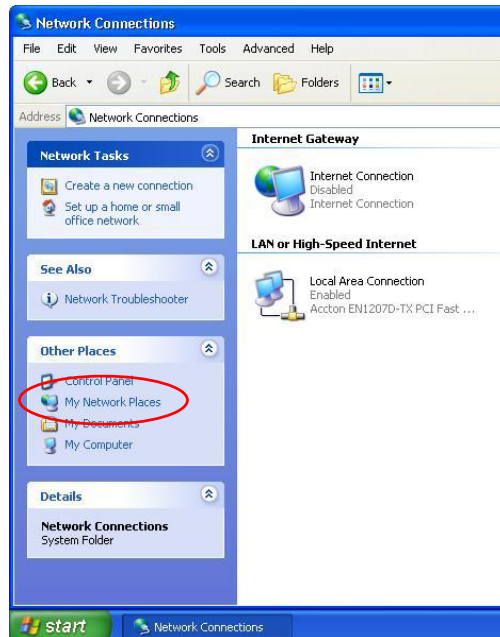

Step 4. An icon with the description for each UPnP-enabled device displays under **Local Network**.

Step 5. Right-click on the icon for your Prestige and select **Invoke**. The web configurator login screen displays.

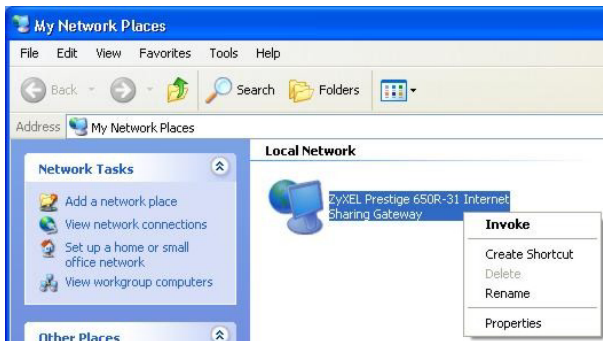

Step 6. Right-click on the icon for your Prestige and select **Properties**. A properties window displays with basic information about the Prestige.



Chapter 20

Logs Screens

This chapter contains information about configuring general log settings and viewing the Prestige's logs. Refer to the appendices for example log message explanations.

20.1 Logs Overview

The web configurator allows you to choose which categories of events and/or alerts to have the Prestige log and then display the logs or have the Prestige send them to an administrator (as e-mail) or to a syslog server.

20.1.1 Alerts and Logs

An alert is a type of log that warrants more serious attention. They include system errors, attacks (access control) and attempted access to blocked web sites. Some categories such as **System Errors** consist of both logs and alerts. You may differentiate them by their color in the **View Log** screen. Alerts display in red and logs display in black.

20.2 Configuring Log Settings

Use the **Log Settings** screen to configure to where the Prestige is to send logs; the schedule for when the Prestige is to send the logs and which logs and/or immediate alerts the Prestige is to record.

To change your Prestige's log settings, click **Logs**, then the **Log Settings**. The screen appears as shown.

Logs - Log Settings

Address Info:

Mail Server: (Outgoing SMTP Server Name or IP Address)

Mail Subject:

Send log to: (E-Mail Address)

Send alerts to: (E-Mail Address)

UNIX Syslog:

Active

Syslog IP Address: (Server Name or IP Address)

Log Facility:

Send Log:

Log Schedule:

Day for Sending Log:

Time for Sending Log: (hour); (minute)

Log	Send immediate alert
<input type="checkbox"/> System Maintenance	<input type="checkbox"/> System Errors
<input type="checkbox"/> System Errors	<input type="checkbox"/> Blocked Web Sites
<input type="checkbox"/> Access Control	<input type="checkbox"/> Attacks
<input type="checkbox"/> UPnP	
<input type="checkbox"/> Forward Web Sites	
<input type="checkbox"/> Blocked Web Sites	
<input type="checkbox"/> Attacks	
<input type="checkbox"/> IPsec	
<input type="checkbox"/> IKE	

Figure 20-1 Log Settings

The following table describes the fields in this screen.

Table 20-1 Log Settings

LABEL	DESCRIPTION
Address Info	
Mail Server	Enter the server name or the IP address of the mail server for the e-mail addresses specified below. If this field is left blank, logs and alert messages will not be sent via e-mail.
Mail Subject	Type a title that you want to be in the subject line of the log e-mail message that the Prestige sends.
Send log to	Logs are sent to the e-mail address specified in this field. If this field is left blank, logs will not be sent via e-mail.
Send alerts to	Alerts are sent to the e-mail address specified in this field. If this field is left blank, alerts will not be sent via e-mail.
UNIX Syslog	UNIX syslog sends a log to an external UNIX server used to store logs.
Active	Click Active to enable UNIX syslog.
Syslog IP Address	Enter the server name or IP address of the syslog server that will log the selected categories of logs.
Log Facility	Select a location from the drop down list box. The log facility allows you to log the messages to different files in the syslog server. Refer to your UNIX manual for more information.
Send Log	
Log Schedule	<p>This drop-down menu is used to configure the frequency of log messages being sent as E-mail:</p> <ul style="list-style-type: none"> • Daily • Weekly • Hourly • When the Log is Full • None. <p>If you select Weekly or Daily, specify a time of day when the E-mail should be sent. If you select Weekly, then also specify which day of the week the E-mail should be sent. If you select When Log is Full, an alert is sent when the log fills up. If you select None, no log messages are sent</p>
Day for Sending Log	Use the drop down list box to select which day of the week to send the logs.
Time for Sending Log	Enter the time of the day in 24-hour format (for example 23:00 equals 11:00 pm) to send the logs.

Table 20-1 Log Settings

LABEL	DESCRIPTION
Log	Select the categories of logs that you want to record. Logs include alerts.
Send Immediate Alert	Select the categories of alerts for which you want the Prestige to instantly e-mail alerts to the e-mail address specified in the Send Alerts To field.
Back	Click Back to return to the previous screen.
Apply	Click Apply to save your customized settings and exit this screen.
Cancel	Click Cancel to return to the previously saved settings.

20.3 Displaying the Logs

Click **Logs** and then **View Logs** to open the **View Logs** screen. Use the **View Logs** screen to see the logs for the categories that you selected in the **Log Settings** screen (see *section 20.2*).

Log entries in red indicate alerts. The log wraps around and deletes the old entries after it fills. Click a column heading to sort the entries. A triangle indicates ascending or descending sort order.



Figure 20-2 View Logs

The following table describes the fields in this screen.

Table 20-2 View Logs

LABEL	DESCRIPTION
Display	The categories that you select in the Log Settings screen (see <i>section 20.2</i>) display in the drop-down list box. Select a category of logs to view; select All Logs to view logs from all of the log categories that you selected in the Log Settings page.
Time	This field displays the time the log was recorded. See the chapter on system maintenance and information to configure the Prestige's time and date.

Table 20-2 View Logs

LABEL	DESCRIPTION
Message	This field states the reason for the log.
Source	This field lists the source IP address and the port number of the incoming packet.
Destination	This field lists the destination IP address and the port number of the incoming packet.
Notes	This field displays additional information about the log entry.
Back	Click Back to return to the previous screen
Email Log Now	Click Email Log Now to send the log screen to the e-mail address specified in the Log Settings page (make sure that you have first filled in the Address Info fields in Log Settings , see <i>section 20.2</i>).
Refresh	Click Refresh to renew the log screen.
Clear Log	Click Clear Log to delete all the logs.

20.4 SMTP Error Messages

If there are difficulties in sending e-mail the following error messages appear. Please see the *Support Notes* on the included disk for information on other types of error messages.

E-mail error messages appear in SMT menu 24.3.1 as "SMTP action request failed. ret= ??". The "??" are described in the following table.

Table 20-3 SMTP Error Messages

-1 means Prestige out of socket
-2 means tcp SYN fail
-3 means smtp server OK fail
-4 means HELO fail
-5 means MAIL FROM fail
-6 means RCPT TO fail
-7 means DATA fail
-8 means mail data send fail

20.4.1 Example E-mail Log

An "End of Log" message displays for each mail in which a complete log has been sent. The following is an example of a log sent by e-mail.

The screenshot shows an email log with several entries. Callouts provide the following information:

- Subject:** Firewall Alert From Prestige (You may edit the subject title)
- Date:** Fri, 07 Apr 2000 10:05:42 (The date format here is Day-Month-Year.)
- Log Entry 1:** 1|Apr 7 00 |From:192.168.1.1 To:192.168.1.255 |default policy |forward | 09:54:03 |UDP src port:00520 dest port:00520 |<1,00> | (The date format here is Month-Day-Year. The time format is Hour-Minute-Second.)
- Log Entry 2:** 2|Apr 7 00 |From:192.168.1.131 To:192.168.1.255 |default policy |forward | 09:54:17 |UDP src port:00520 dest port:00520 |<1,00> |
- Log Entry 3:** 3|Apr 7 00 |From:192.168.1.6 To:10.10.10.10 |match |forward | 09:54:19 |UDP src port:03516 dest port:00053 |<1,01> |
- Log Entry 126:** 126|Apr 7 00 |From:192.168.1.1 To:192.168.1.255 |match |forward | 10:05:00 |UDP src port:00520 dest port:00520 |<1,02> |
- Log Entry 127:** 127|Apr 7 00 |From:192.168.1.131 To:192.168.1.255 |match |forward | 10:05:17 |UDP src port:00520 dest port:00520 |<1,02> |
- Log Entry 128:** 128|Apr 7 00 |From:192.168.1.1 To:192.168.1.255 |match |forward | 10:05:30 |UDP src port:00520 dest port:00520 |<1,02> |
- End of Log:** End of Firewall Log ("End of Log" message shows that a complete log has been sent.)

Figure 20-3 E-mail Log Example

Part VII:

Bandwidth Management

This part provides information on the functions and configuration of Bandwidth Management.

Chapter 21

Bandwidth Management

This chapter describes the functions and configuration of bandwidth management.

21.1 Bandwidth Management Overview

Bandwidth management allows you to allocate an interface's outgoing capacity to specific types of traffic. It can also help you make sure that the Prestige forwards certain types of traffic (especially real-time applications) with minimum delay. With the use of real-time applications such as Voice-over-IP (VoIP) increasing, the requirement for bandwidth allocation is also increasing.

Bandwidth management addresses questions such as:

- Who gets how much access to specific applications?
- What priority level should you give to each type of traffic?
- Which traffic must have guaranteed delivery?
- How much bandwidth should be allotted to guarantee delivery?

Bandwidth management also allows you to configure the allowed output for an interface to match what the network can handle. This helps reduce delays and dropped packets at the next routing device. For example, you can set the WAN interface speed to 1000kbps if the ADSL connection has an upstream speed of 1000kbps. All configuration screens display measurements in kbps (kilobits per second), but this *User's Guide* also uses Mbps (megabits per second) for brevity's sake.

21.2 Bandwidth Classes and Filters

Use bandwidth classes and child-classes to allocate specific amounts of bandwidth capacity (bandwidth budgets). Configure a bandwidth filter to define a bandwidth class (or child-class) based on a specific application and/or subnet. Use the **Class Configuration** tab (see *section 21.9.1*) to set up a bandwidth class's name, bandwidth allotment, and bandwidth filter. You can configure up to one bandwidth filter per bandwidth class. You can also configure bandwidth classes without bandwidth filters. However, it is recommended that you configure child-classes with filters for any classes that you configure without filters. The Prestige leaves the bandwidth budget allocated and unused for a class that does not have a filter itself or child-classes with filters. View your configured bandwidth classes and child-classes in the **Class Setup** tab (see *section 21.9* for details).

The total of the configured bandwidth budgets for child-classes cannot exceed the configured bandwidth budget speed of the parent class.

21.3 Proportional Bandwidth Allocation

Bandwidth management allows you to define how much bandwidth each class gets; however, the actual bandwidth allotted to each class decreases or increases in proportion to actual available bandwidth.

21.4 Bandwidth Management Usage Examples

These examples show bandwidth management allotments on a WAN interface that is configured for 640Kbps.

21.4.1 Application-based Bandwidth Management Example

The bandwidth classes in the following example are based solely on application. Each bandwidth class (VoIP, Web, FTP, E-mail and Video) is allotted 128kbps.

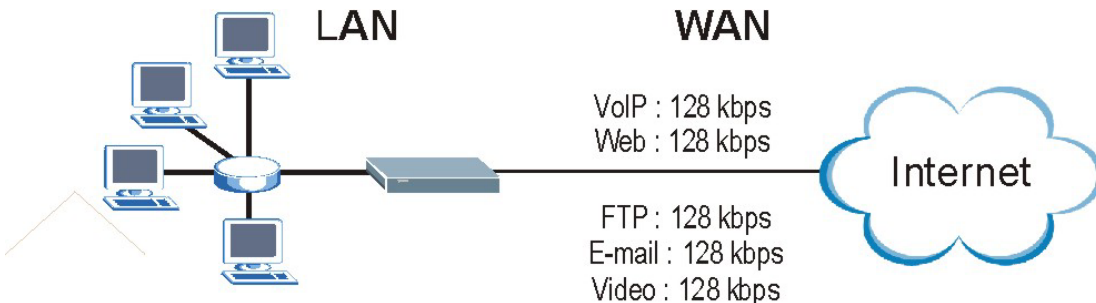

Figure 21-1 Application-based Bandwidth Management Example

21.4.2 Subnet-based Bandwidth Management Example

The following example uses bandwidth classes based solely on LAN subnets. Each bandwidth class (Subnet A and Subnet B) is allotted 320kbps.

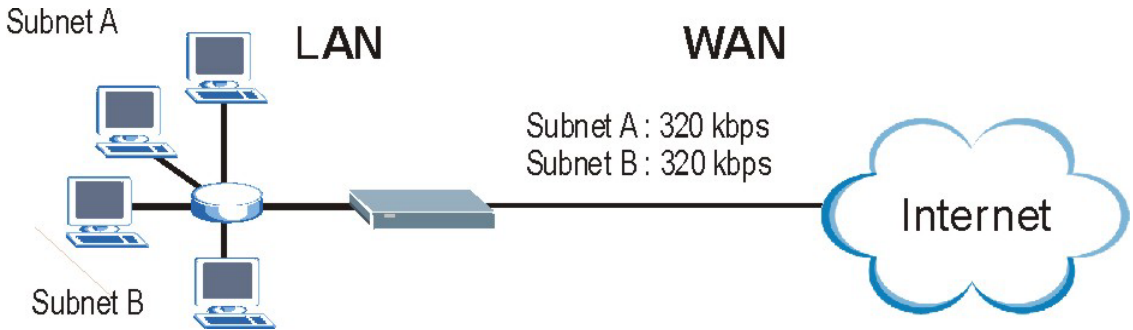

Figure 21-2 Subnet-based Bandwidth Management Example

21.4.3 Application and Subnet-based Bandwidth Management Example

The following example uses bandwidth classes based on LAN subnets and applications (specific applications in each subnet are allotted bandwidth).

Table 21-1 Application and Subnet-based Bandwidth Management Example

TRAFFIC TYPE	FROM SUBNET A	FROM SUBNET B
VoIP	64 kbps	64 kbps
Web	64 kbps	64 kbps
FTP	64 kbps	64 kbps
E-mail	64 kbps	64 kbps
Video	64 kbps	64 kbps

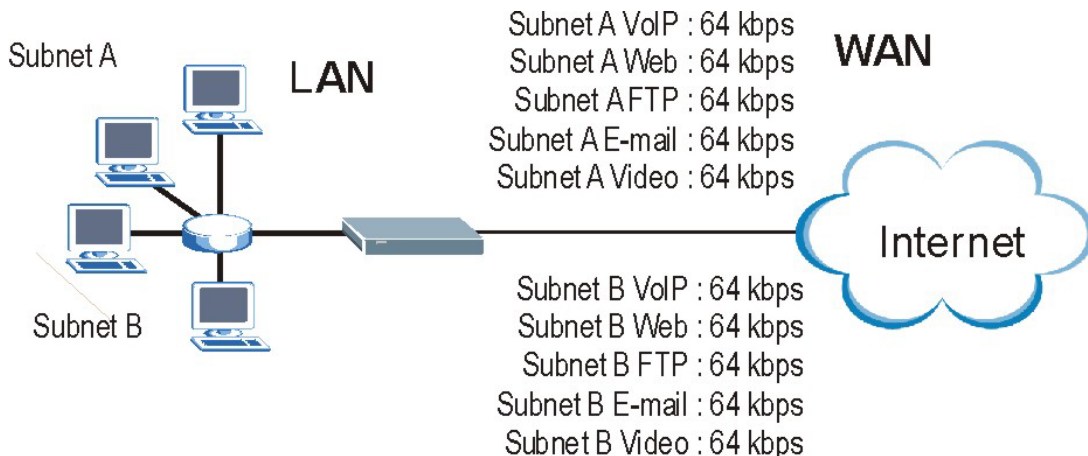

Figure 21-3 Application and Subnet-based Bandwidth Management Example

21.5 Scheduler

The scheduler divides up an interface's bandwidth among the bandwidth classes. The Prestige has two types of scheduler: fairness-based and priority-based.

21.5.1 Priority-based Scheduler

With the priority-based scheduler, the Prestige forwards traffic from bandwidth classes according to the priorities that you assign to the bandwidth classes. The larger a bandwidth class's priority number is, the higher the priority. Assign real-time applications (like those using audio or video) a higher priority number to provide smoother operation.

21.5.2 Fairness-based Scheduler

The Prestige divides bandwidth equally among bandwidth classes when using the fairness-based scheduler; thus preventing one bandwidth class from using all of the interface's bandwidth.

21.6 Maximize Bandwidth Usage

The maximize bandwidth usage option (see *Figure 21-7*) allows the Prestige to divide up any available bandwidth on the interface (including unallocated bandwidth and any allocated bandwidth that a class is not using) among the bandwidth classes that require more bandwidth.

When you enable maximize bandwidth usage, the Prestige first makes sure that each bandwidth class gets up to its bandwidth allotment. Next, the Prestige divides up an interface's available bandwidth (bandwidth that is unbudgeted or unused by the classes) depending on how many bandwidth classes require more bandwidth and on their priority levels. When only one class requires more bandwidth, the Prestige gives extra bandwidth to that class.

When multiple classes require more bandwidth, the Prestige gives the highest priority classes the available bandwidth first (as much as they require, if there is enough available bandwidth), and then to lower priority classes if there is still bandwidth available. The Prestige distributes the available bandwidth equally among classes with the same priority level.

21.6.1 Reserving Bandwidth for Non-Bandwidth Class Traffic

Do the following three steps to configure the Prestige to allow bandwidth for traffic that is not defined in a bandwidth filter.

Leave some of the interface's bandwidth unbudgeted.

Do not enable the interface's **Maximize Bandwidth Usage** option.

Do not enable bandwidth borrowing on the child-classes that have the root class as their parent (see *section 21.7*).

21.6.2 Maximize Bandwidth Usage Example

Here is an example of a Prestige that has maximized bandwidth usage enabled on an interface. The first figure shows each bandwidth class's bandwidth budget and priority. The classes are set up based on subnets. The interface is set to 10 Mbps. Each subnet is allocated 2 Mbps. The unbudgeted 2 Mbps allows traffic not defined in one of the bandwidth filters to go out when you do not select the maximize bandwidth option.

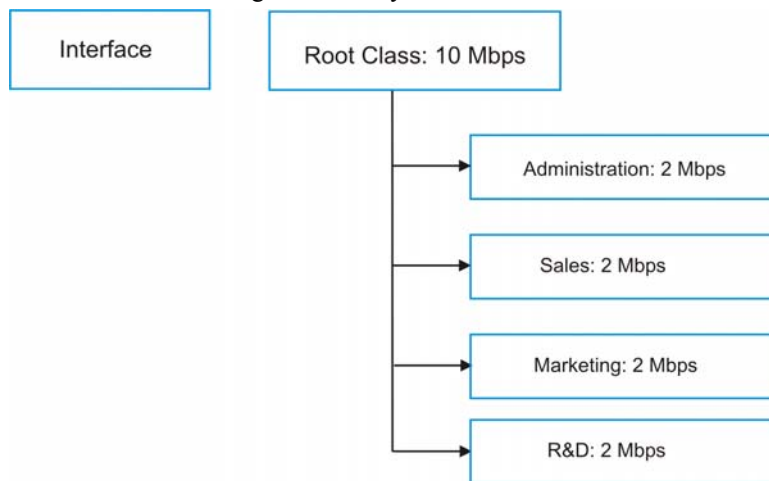

Figure 21-4 Bandwidth Allotment Example

The following figure shows the bandwidth usage with the maximize bandwidth usage option enabled. The Prestige divides up the unbudgeted 2 Mbps among the classes that require more bandwidth. If the administration department only uses 1 Mbps of the budgeted 2 Mbps, the Prestige also divides the remaining 1 Mbps among the classes that require more bandwidth. Therefore, the Prestige divides a total of 3 Mbps total of unbudgeted and unused bandwidth among the classes that require more bandwidth.

In this case, suppose that all of the classes except for the administration class need more bandwidth.

- Each class gets up to its budgeted bandwidth. The administration class only uses 1 Mbps of its budgeted 2 Mbps.
- Sales and Marketing are first to get extra bandwidth because they have the highest priority (6). If they each require 1.5 Mbps or more of extra bandwidth, the Prestige divides the total 3 Mbps total of unbudgeted and unused bandwidth equally between the sales and marketing departments (1.5 Mbps extra to each for a total of 3.5 Mbps for each) because they both have the highest priority level.
- R&D requires more bandwidth but only gets its budgeted 2 Mbps because all of the unbudgeted and unused bandwidth goes to the higher priority sales and marketing classes.
- The Prestige does not send any traffic that is not defined in the bandwidth filters because all of the unbudgeted bandwidth goes to the classes that need it.

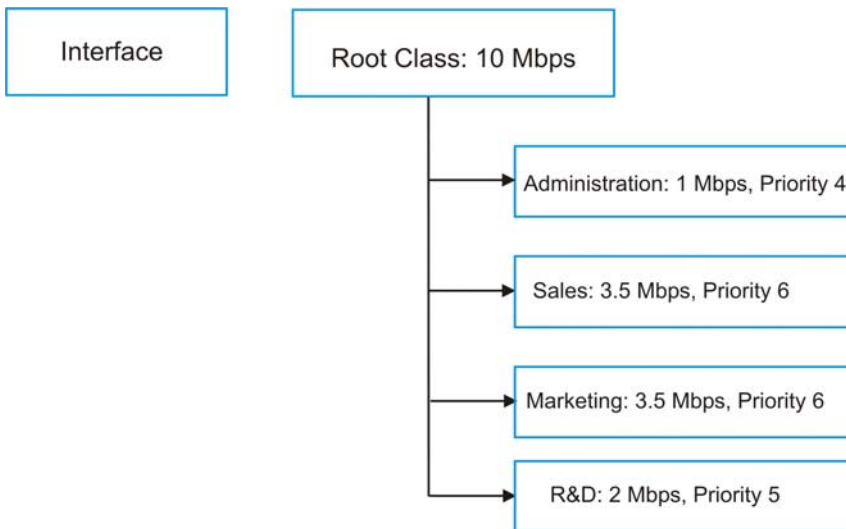

Figure 21-5 Maximize Bandwidth Usage Example

21.7 Bandwidth Borrowing

Bandwidth borrowing allows a child-class to borrow unused bandwidth from its parent class, whereas maximize bandwidth usage allows bandwidth classes to borrow any unused or unbudgeted bandwidth on the whole interface.

Enable bandwidth borrowing on a child-class to allow the child-class to use its parent class's unused bandwidth. A parent class's unused bandwidth is given to the highest priority child-class first. The child-class can also borrow bandwidth from a higher parent class (grandparent class) if the child-class's parent class is also configured to borrow bandwidth from its parent class. This can go on for as many levels as are configured to borrow bandwidth from their parent class (see *section 21.7.1*).

The total of the bandwidth allotments for child-classes cannot exceed the bandwidth allotment of their parent class. The Prestige uses the scheduler to divide a parent class's unused bandwidth among the child-classes.

21.7.1 Bandwidth Borrowing Example

Here is an example of bandwidth management with classes configured for bandwidth borrowing. The classes are set up based on departments and individuals within certain departments.

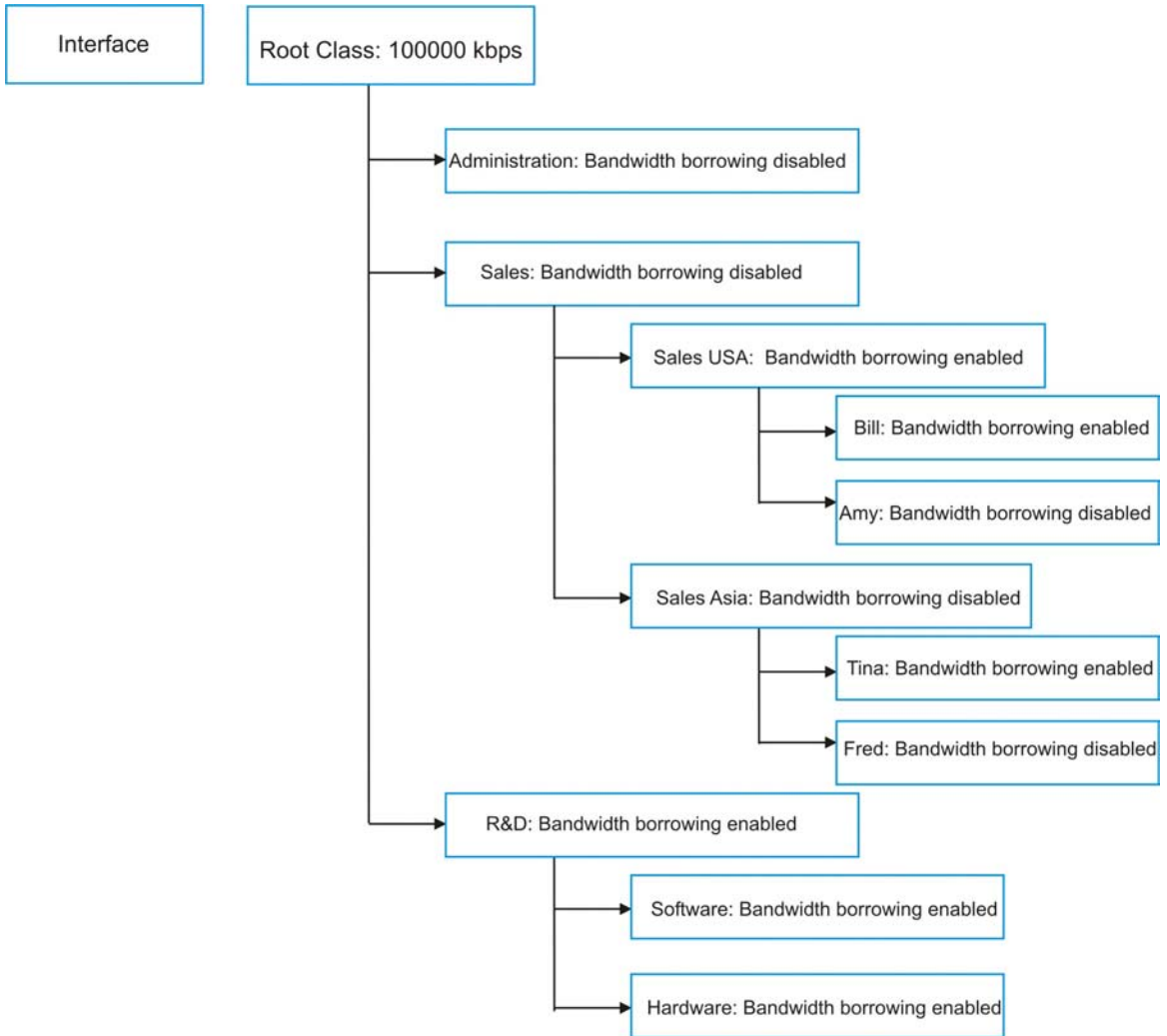

Figure 21-6 Bandwidth Borrowing Example

- The Bill class can borrow unused bandwidth from the Sales USA class because the Bill class has bandwidth borrowing enabled.
- The Bill class can also borrow unused bandwidth from the Sales class because the Sales USA class also has bandwidth borrowing enabled.

- The Bill class cannot borrow unused bandwidth from the Root class because the Sales class has bandwidth borrowing disabled.
- The Amy class cannot borrow unused bandwidth from the Sales USA class because the Amy class has bandwidth borrowing disabled.
- The R&D Software and Hardware classes can both borrow unused bandwidth from the R&D class because the R&D Software and Hardware classes both have bandwidth borrowing enabled.
- The R&D Software and Hardware classes can also borrow unused bandwidth from the Root class because the R&D class also has bandwidth borrowing enabled.

21.7.2 Maximize Bandwidth Usage With Bandwidth Borrowing

If you configure both maximize bandwidth usage (on the interface) and bandwidth borrowing (on individual child-classes), the Prestige functions as follows.

1. The Prestige sends traffic according to each bandwidth class's bandwidth budget.
2. The Prestige assigns a parent class's unused bandwidth to its child-classes that have more traffic than their budgets and have bandwidth borrowing enabled. The Prestige gives priority to bandwidth child-classes of higher priority and treats bandwidth classes of the same priority equally.
3. The Prestige assigns any remaining unused or unbudgeted bandwidth on the interface to any bandwidth class that requires it. The Prestige gives priority to bandwidth classes of higher priority and treats bandwidth classes of the same level equally.
4. The Prestige assigns any remaining unbudgeted bandwidth to traffic that does not match any of the bandwidth classes.

21.8 Configuring Summary

Click **BW Manager, Summary** to open the **Summary** screen.

Enable bandwidth management on an interface and set the maximum allowed bandwidth for that interface.

BW Manager - Summary

BW Manager manages the bandwidth of traffic flowing out of router on the specific interface. BW Manager can be switched on/off independently for each interface.

Server Type	Active	Speed (kbps)	Scheduler	Max Bandwidth Usage
LAN	<input checked="" type="checkbox"/>	<input type="text" value="50000"/>	Fairness-Based ▾	<input checked="" type="checkbox"/> Yes
WLAN	<input type="checkbox"/>	<input type="text" value="0"/>	Priority-Based ▾	<input type="checkbox"/> Yes
WAN	<input type="checkbox"/>	<input type="text" value="0"/>	Priority-Based ▾	<input type="checkbox"/> Yes

Figure 21-7 Bandwidth Manager: Summary

The following table describes the labels in this screen.

Table 21-2 Bandwidth Manager: Summary

LABEL	DESCRIPTION
LAN WLAN WAN	These read-only labels represent the physical interfaces.
Active	Select an interface's check box to enable bandwidth management on that interface.
Speed (kbps)	Enter the amount of bandwidth for this interface that you want to allocate using bandwidth management. This appears as the bandwidth budget of the interface's root class (see <i>section 21.9</i>). The recommendation is to set this speed to match what the interface's connection can handle. For example, set the WAN interface speed to 1000 kbps if the ADSL connection has an upstream speed of 1000 kbps.

Table 21-2 Bandwidth Manager: Summary

LABEL	DESCRIPTION
Scheduler	Select either Priority-Based or Fairness-Based from the drop-down menu to control the traffic flow. Select Priority-Based to give preference to bandwidth classes with higher priorities. Select Fairness-Based to treat all bandwidth classes equally. See <i>section 21.5</i> .
Maximize Bandwidth Usage	Select this check box to have the Prestige divide up all of the interface's unallocated and/or unused bandwidth among the bandwidth classes that require bandwidth. Do not select this if you want to reserve bandwidth for traffic that does not match a bandwidth class (see <i>section 21.6.1</i>) or you want to limit the speed of this interface (see the Speed field description).
Back	Click Back to go to the main BW Manager screen.
Apply	Click Apply to save your settings back to the Prestige.
Cancel	Click Cancel to begin configuring this screen afresh.

21.9 Configuring Class Setup

The class setup screen displays the configured bandwidth classes by individual interface. Select an interface and click the buttons to perform the actions described next. Click “+” to expand the class tree or click “-“ to collapse the class tree. Each interface has a permanent root class. The bandwidth budget of the root class is equal to the speed you configured on the interface (see *section 21.8* to configure the speed of the interface). Configure child-class layers for the root class.

To add or delete child classes on an interface, click **BW Manager**, then **Class Setup**. The screen appears as shown (with example classes).

The example reserves 15 Mbps of unbudgeted bandwidth for traffic that is not defined in the bandwidth filters (see *section 21.6.1*). The Administration and Sales USA bandwidth classes each have bigger bandwidth budgets than the total of the budgets of their child-classes. The child-classes can borrow the extra bandwidth as long as they have bandwidth borrowing enabled (see *section 21.7*).

BW Manager- Class Setup

Interface

- Root Class: 100000 kbps**
 - Administration: 15000 kbps**
 - CEO: 5000 kbps**
 - Vice President: 5000 kbps**
 - SalesUSA: 15000 kbps**
 - Bill: 5000 kbps**
 - SalesAsia: 15000 kbps**
 - R&D Hardware: 15000 kbps**
 - R&D Software: 15000 kbps**
 - Production: 15000 kbps**

Figure 21-8 Bandwidth Manager: Class Setup

The following table describes the labels in this screen.

Table 21-3 Bandwidth Manager: Class Setup

LABEL	DESCRIPTION
Interface	Select an interface from the drop-down list box for which you wish to set up classes.
Back	Click Back to go to the main BW Manager screen.
Add Child-Class	Click Add Child-class to add a sub-class.
Edit	Click Edit to configure the selected class. You cannot edit the root class.
Delete	Click Delete to delete the class and all its child-classes. You cannot delete the root class.

Table 21-3 Bandwidth Manager: Class Setup

LABEL	DESCRIPTION
Statistics	Click Statistics to display the status of the selected class.

21.9.1 Bandwidth Manager Class Configuration

Configure a bandwidth management class in the **Class Configuration** screen. You must use the **Bandwidth Manager - Summary** screen to enable bandwidth management on an interface before you can configure classes for that interface.

To add a child class, click **BW Manager**, then **Class Setup**. Click the **Add Child-Class** button to open the following screen.

BW Manager- Class Configuration

Class Name

BW Budget (kbps)

Priority (0-7)

Borrow bandwidth from parent class

Bandwidth Filter

Active

Application

Destination IP Address

Destination Subnet Mask

Destination Port

Source IP Address

Source Subnet Mask

Source Port

Protocol ID

Figure 21-9 Bandwidth Manager: Class Configuration

The following table describes the labels in this screen.

Table 21-4 Bandwidth Manager: Class Configuration

LABEL	DESCRIPTION
Class Name	Use the auto-generated name or enter a descriptive name of up to 20 alphanumeric characters, including spaces.

Table 21-4 Bandwidth Manager: Class Configuration

LABEL	DESCRIPTION
BW Budget (kbps)	Specify the maximum bandwidth allowed for the class in kbps. The recommendation is a setting between 20 kbps and 20000 kbps for an individual class.
Priority	Enter a number between 0 and 7 to set the priority of this class. The higher the number, the higher the priority. The default setting is 3.
Borrow bandwidth from parent class	<p>Select this option to allow a child-class to borrow bandwidth from its parent class if the parent class is not using up its bandwidth budget.</p> <p>Bandwidth borrowing is governed by the priority of the child-classes. That is, a child-class with the highest priority (7) is the first to borrow bandwidth from its parent class.</p> <p>Do not select this for the classes directly below the root class if you want to leave bandwidth available for other traffic types (see 21.6.1) or you want to set the interface's speed to match what the next device in network can handle (see the Speed field description in <i>Table 21-2</i>).</p>
<p>Bandwidth Filter</p> <p>The Prestige uses a bandwidth filter to identify the traffic that belongs to a bandwidth class.</p>	
Active	Select the check box to have the Prestige use this bandwidth filter when it performs bandwidth management.
Service	<p>You can select a predefined service instead of configuring the Destination Port, Source Port and Protocol ID fields.</p> <p>SIP (Session Initiation Protocol) is a signaling protocol used in Internet telephony, instant messaging and other VoIP (Voice over IP) applications. Select SIP from the drop-down list box to configure this bandwidth filter for traffic that uses SIP. At the time of writing, SIP was the only predefined service.</p> <p>When you select None, the bandwidth class applies to all services unless you specify one by configuring the Destination Port, Source Port and Protocol ID fields.</p>
Destination IP Address	Enter the destination IP address in dotted decimal notation. A blank destination IP address means any destination IP address.
Destination Subnet Mask	Enter the destination subnet mask. This field is N/A if you do not specify a Destination IP Address . Refer to the appendix for more information on IP subnetting.
Destination Port	Enter the port number of the destination. A blank destination port means any destination port.

Table 21-4 Bandwidth Manager: Class Configuration

LABEL	DESCRIPTION
Source IP Address	Enter the source IP address. A blank source IP address means any source IP address.
Source Subnet Mask	Enter the source subnet mask. This field is N/A if you do not specify a Source IP Address . Refer to the appendix for more information on IP subnetting.
Source Port	Enter the port number of the source. See the following table for some common services and port numbers. A blank source port means any source port number.
Protocol ID	Enter the protocol ID (service type) number, for example: 1 for ICMP, 6 for TCP or 17 for UDP. A blank protocol ID means any protocol number.
Back	Click Back to go to the main BW Manager screen.
Apply	Click Apply to save your changes back to the Prestige.
Cancel	Click Cancel to begin configuring this screen afresh.

Table 21-5 Services and Port Numbers

SERVICES	PORT NUMBER
ECHO	7
FTP (File Transfer Protocol)	21
SMTP (Simple Mail Transfer Protocol)	25
DNS (Domain Name System)	53
Finger	79
HTTP (Hyper Text Transfer protocol or WWW, Web)	80
POP3 (Post Office Protocol)	110
NNTP (Network News Transport Protocol)	119
SNMP (Simple Network Management Protocol)	161
SNMP trap	162
PPTP (Point-to-Point Tunneling Protocol)	1723

21.9.2 Bandwidth Management Statistics

Use the **Bandwidth Management Statistics** screen to view network performance information. Click the **Statistics** button in the **Class Setup** screen to open the **Statistics** screen.

Class Name:		Budget: (kbps)					
Tx Packets	Tx Bytes	Dropped Packets	Dropped Bytes				
Bandwidth Statistics for the Past 8 Seconds							
t-8	t-7	t-6	t-5	t-4	t-3	t-2	t-1
Update Period <input type="text" value="5"/> (Seconds)		Set Interval	Stop	Clear Counter			

Figure 21-10 Bandwidth Management Statistics

The following table describes the labels in this screen.

Table 21-6 Bandwidth Management Statistics

LABEL	DESCRIPTION
Class Name	This field displays the name of the class the statistics page is showing.
Budget (kbps)	This field displays the amount of bandwidth allocated to the class.
Tx Packets	This field displays the total number of packets transmitted.
Tx Bytes	This field displays the total number of bytes transmitted.
Dropped Packets	This field displays the total number of packets dropped.
Dropped Bytes	This field displays the total number of bytes dropped.
Bandwidth Statistics for the Past 8 Seconds (t-8 to t-1)	
This field displays the bandwidth statistics (in bps) for the past one to eight seconds. For example, t-1 means one second ago.	
Update Period (seconds)	Enter the time interval in seconds to define how often the information should be refreshed.

Table 21-6 Bandwidth Management Statistics

LABEL	DESCRIPTION
Set Interval	Click Set Interval to apply the new update period you entered in the Update Period field above.
Stop Update	Click Stop Update to stop the browser from refreshing bandwidth management statistics.
Clear Counter	Click Clear Counter to clear all of the bandwidth management statistics.

21.10 Configuring Monitor

To view the Prestige's bandwidth usage and allotments, click **BW Manager**, then **Monitor**. The screen appears as shown.

BW Manager-Monitor

Interface

Class Name	Budget (kbps)	Current Usage (kbps)
Root Class	50000	140

Figure 21-11 Bandwidth Manager Monitor

The following table describes the labels in this screen.

Table 21-7 Bandwidth Manager Monitor

LABEL	DESCRIPTION
Interface	Select an interface from the drop-down list box to view the bandwidth usage of its bandwidth classes.
Class Name	This field displays the name of the class.
Budget (kbps)	This field displays the amount of bandwidth allocated to the class.
Current Usage (kbps)	This field displays the amount of bandwidth that each class is using.

Table 21-7 Bandwidth Manager Monitor

LABEL	DESCRIPTION
Back	Click Back to go to the main BW Manager screen.
Refresh	Click Refresh to update the page.

Part VIII:

Maintenance

This part covers the maintenance screens.

Chapter 22

Maintenance

This chapter displays system information such as ZyNOS firmware, port IP addresses and port traffic statistics.

22.1 Maintenance Overview

The maintenance screens can help you view system information, upload new firmware, manage configuration and restart your Prestige.

22.2 System Status Screen

Click **System Status** to open the following screen, where you can use to monitor your Prestige. Note that these fields are READ-ONLY and only for diagnostic purposes.

System Status

System Status

System Name : 652HWI
ZyNOS FW Version: V3.40(OA.0)b1 | 08/08/2003
DSL FW Version: 13.9.22
Standard: Multi-Mode

DSL Information

IP Address: 0.0.0.0
IP Subnet Mask: 0.0.0.0
Default Gateway: 0.0.0.0
VPI/VCI: 22/ 222

LAN Information

MAC Address: 00:a0:c5:5a:da:70
IP Address: 192.168.2.1
IP Subnet Mask: 255.255.255.0
DHCP: Server
DHCP Start IP: 192.168.2.33
DHCP Pool Size: 6

Show Statistics

Figure 22-1 System Status

The following table describes the fields in this screen.

Table 22-1 System Status

LABEL	DESCRIPTION
System Status	
System Name	This is the name of your Prestige. It is for identification purposes.
ZyNOS Firmware Version	This is the ZyNOS firmware version and the date created. ZyNOS is ZyXEL's proprietary Network Operating System design.
DSL FW Version	This is the DSL firmware version associated with your Prestige.
Standard	This is the standard that your Prestige is using.
DSL Information	
IP Address	This is the DSL port IP address.
IP Subnet Mask	This is the DSL port IP subnet mask.
Default Gateway	This is the IP address of the default gateway, if applicable.
VPI/VCI	This is the Virtual Path Identifier and Virtual Channel Identifier that you entered in the first Wizard screen.
LAN Information	
MAC Address	This is the MAC (Media Access Control) or Ethernet address unique to your Prestige.
IP Address	This is the LAN port IP address.
IP Subnet Mask	This is the LAN port IP subnet mask.
DHCP	This is the WAN port DHCP role - Server , Relay (not all Prestige models) or None .
DHCP Start IP	This is the first of the contiguous addresses in the IP address pool.
DHCP Pool Size	This is the number of IP addresses in the IP address pool.

Table 22-1 System Status

LABEL	DESCRIPTION
Show Statistics	Click Show Statistics to see router performance statistics such as number of packets sent and number of packets received for each port.

22.2.1 System Statistics

Click **Show Statistics** in the **System Status** screen to open the following screen. Read-only information here includes port status and packet specific statistics. Also provided are "system up time" and "poll interval(s)". The **Poll Interval(s)** field is configurable.

System up Time: 0:03:11
CPU Load: **1.99%**

DSL Port Statistics:
Link Status: **Wait for Init**
Upstream Speed: **0 kbps**
Downstream Speed: **0 kbps**

Node-Link	Status	TxPkts	RxPkts	Errors	Tx B/s	Rx B/s	Up Time
1-PPPoA	N/A	0	0	0	0	0	0:00:00

ISDN Port Statistics:

Node-Link	Status	TxPkts	RxPkts	Errors	Up Time
B1	OK	0	0	0	0:00:00
B2	OK	0	0	0	0:00:00

LAN Port Statistics:

Interface:	Status	TxPkts	RxPkts	Collisions
Ethernet	Up	88	217	0
Wireless	54M	153	0	0

Poll Interval(s) :

Figure 22-2 System Status: Show Statistics

The following table describes the fields in this screen.

Table 22-2 System Status: Show Statistics

LABEL	DESCRIPTION
System up Time	This is the elapsed time the system has been up.
CPU Load	This field specifies the percentage of CPU utilization.
DSL Port Statistics	This is the DSL port.
Link Status	This is the status of your DSL link.
Upstream Speed	This is the upstream speed of your Prestige.
Downstream Speed	This is the downstream speed of your Prestige.
Node-Link	This field displays the remote node index number and link type. Link types are PPPoA, ENET, RFC 1483 and PPPoE.
Interface	This field displays the type of port.
Status	For the DSL port, this displays the port speed and duplex setting if you're using Ethernet encapsulation and down (line is down), idle (line (ppp) idle), dial (starting to trigger a call) and drop (dropping a call) if you're using PPPoE encapsulation. For a LAN port, this shows the port speed and duplex setting.
TxPkts	This field displays the number of packets transmitted on this port.
RxPkts	This field displays the number of packets received on this port.
Errors	This field displays the number of error packets on this port.
Tx B/s	This field displays the number of bytes transmitted in the last second.
Rx B/s	This field displays the number of bytes received in the last second.
Up Time	This field displays the elapsed time this port has been up.
Collisions	This is the number of collisions on this port.
Poll Interval(s)	Type the time interval for the browser to refresh system statistics.

Table 22-2 System Status: Show Statistics

LABEL	DESCRIPTION
Set Interval	Click this button to apply the new poll interval you entered in the Poll Interval field above.
Stop	Click this button to halt the refreshing of the system statistics.

22.3 DHCP Table Screen

DHCP (Dynamic Host Configuration Protocol, RFC 2131 and RFC 2132) allows individual clients to obtain TCP/IP configuration at start-up from a server. You can configure the Prestige as a DHCP server or disable it. When configured as a server, the Prestige provides the TCP/IP configuration for the clients. If set to **None**, DHCP service will be disabled and you must have another DHCP server on your LAN, or else the computer must be manually configured.

Click **MAINTENANCE**, and then the **DHCP Table** tab. Read-only information here relates to your DHCP status. The DHCP table shows current DHCP Client information (including **IP Address**, **Host Name** and **MAC Address**) of all network clients using the DHCP server.

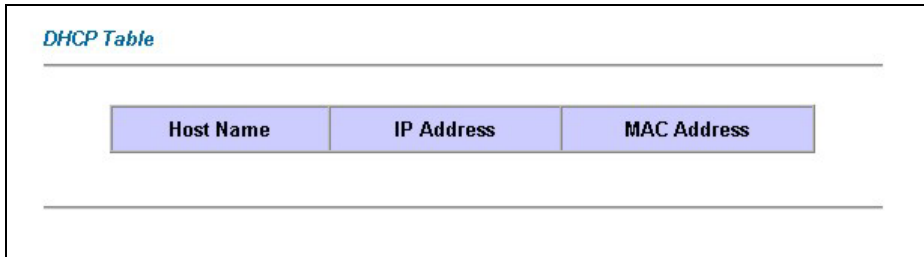

Figure 22-3 DHCP Table

The following table describes the fields in this screen.

Table 22-3 DHCP Table

LABEL	DESCRIPTION
Host Name	This is the name of the host computer.
IP Address	This field displays the IP address relative to the Host Name field.

Table 22-3 DHCP Table

LABEL	DESCRIPTION
MAC Address	<p>This field displays the MAC (Media Access Control) address of the computer with the displayed host name.</p> <p>Every Ethernet device has a unique MAC address. The MAC address is assigned at the factory and consists of six pairs of hexadecimal characters, for example, 00:A0:C5:00:00:02.</p>

22.4 Wireless Screens

These read-only screens display information about the Prestige's wireless LAN.

22.4.1 Association List

This screen displays the MAC address(es) of the wireless clients that are currently logged in to the network. Click **Wireless LAN** and then **Association List** to open the screen shown next.

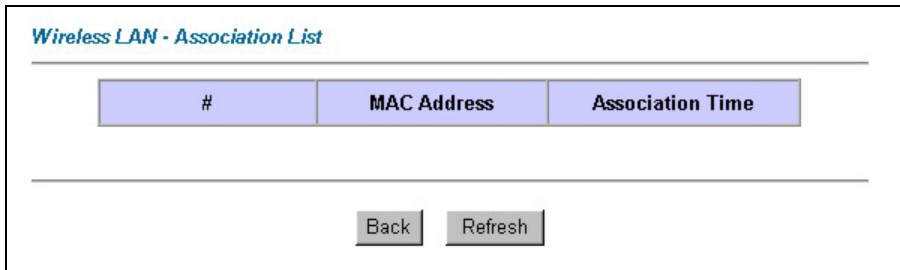

#	MAC Address	Association Time

Figure 22-4 Association List

The following table describes the fields in this screen.

Table 22-4 Association List

LABEL	DESCRIPTION
#	This is the index number of an associated wireless client.
MAC Address	<p>This field displays the MAC (Media Access Control) address of an associated wireless client.</p> <p>Every Ethernet device has a unique MAC address. The MAC address is assigned at the factory and consists of six pairs of hexadecimal characters, for example, 00:A0:C5:00:00:02.</p>

Table 22-4 Association List

LABEL	DESCRIPTION
Association Time	This field displays how long a wireless client has been associated to the Prestige.
Back	Click Back to return to the previous screen.
Refresh	Click Refresh to renew the information in the table.

22.4.2 Channel Usage Table

This screen displays the state of the channels within the Prestige's transmission range. Click **Wireless LAN** and then **Channel Usage Table** to open the screen shown next.

Wireless LAN - Channel Usage Table

Channel	Activity
1	Yes
2	Yes
3	Yes
4	Yes
5	Yes
6	Yes
7	Yes
8	No
9	No
10	No
11	Yes

Back Refresh

Figure 22-5 Channel Usage Table

The following table describes the fields in this screen.

Table 22-5 Channel Usage Table

LABEL	DESCRIPTION
Channel	This is the index number of the channel.
Activity	This field displays Yes if another AP or Ad-hoc network is using the channel within the Prestige's transmission range.
Back	Click Back to return to the previous screen.
Refresh	Click Refresh to renew the information in the table.

22.5 Diagnostic Screens

These read-only screens display information to help you identify problems with the Prestige.

22.5.1 Diagnostic General Screen

Click **Diagnostic** and then **General** to open the screen shown next.

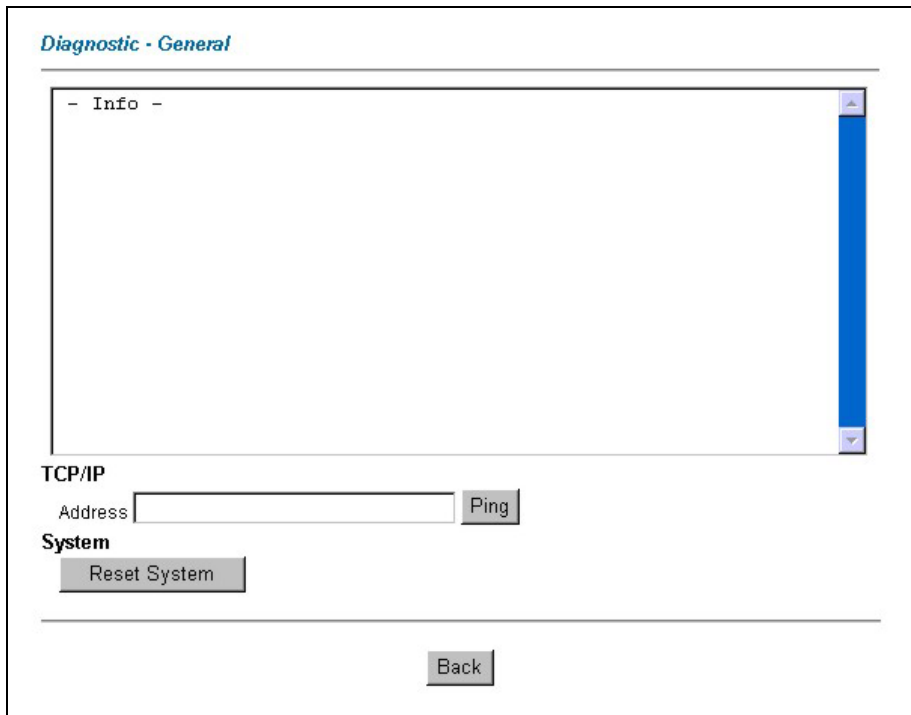

Figure 22-6 Diagnostic General

The following table describes the fields in this screen.

Table 22-6 Diagnostic General

LABEL	DESCRIPTION
TCP/IP Address	Type the IP address of a computer that you want to ping in order to test a connection.
Ping	Click this button to ping the IP address that you entered.
Reset System	Click this button to reboot the Prestige. A warning dialog box is then displayed asking you if you're sure you want to reboot the system. Click OK to proceed.
Back	Click this button to go back to the main Diagnostic screen.

22.5.2 Diagnostic DSL Line Screen

Click **Diagnostic** and then **DSL Line** to open the screen shown next.

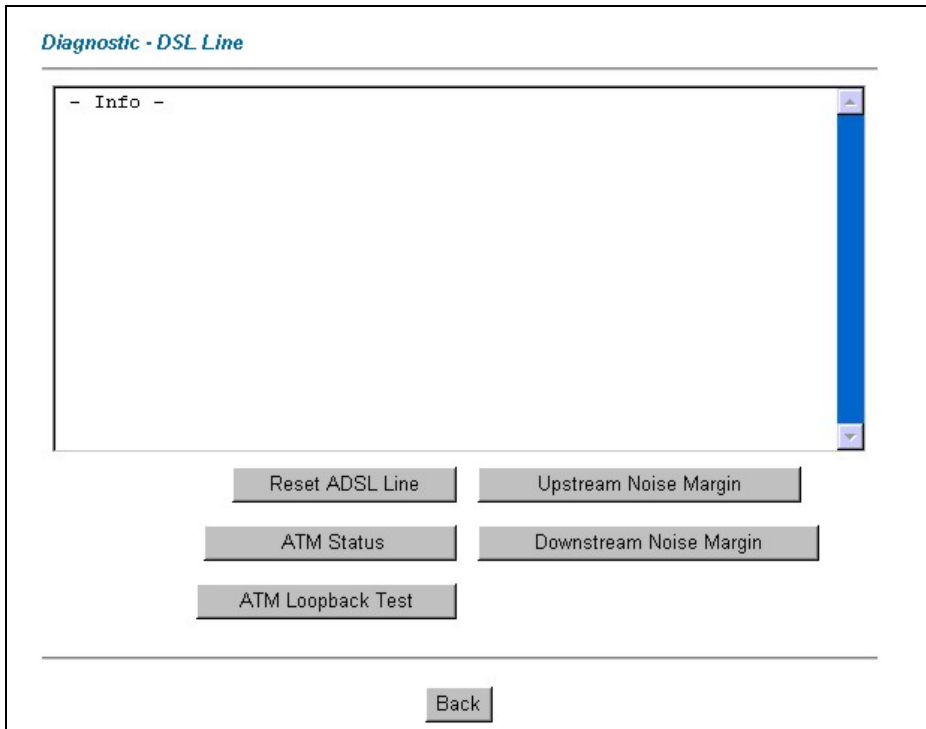

Figure 22-7 Diagnostic DSL Line

The following table describes the fields in this screen.

Table 22-7 Diagnostic DSL Line

LABEL	DESCRIPTION
Reset ADSL Line	Click this button to reinitialize the ADSL line. The large text box above then displays the progress and results of this operation, for example: "Start to reset ADSL Loading ADSL modem F/W... Reset ADSL Line Successfully!"
ATM Status	Click this button to view ATM status.

Table 22-7 Diagnostic DSL Line

LABEL	DESCRIPTION
ATM Loopback Test	Click this button to start the ATM loopback test. Make sure you have configured at least one PVC with proper VPIs/VCIs before you begin this test. The Prestige sends an OAM F5 packet to the DSLAM/ATM switch and then returns it (loops it back) to the Prestige. The ATM loopback test is useful for troubleshooting problems with the DSLAM and ATM network.
Upstream Noise Margin	Click this button to display the upstream noise margin.
Downstream Noise Margin	Click this button to display the downstream noise margin.
Back	Click this button to go back to the main Diagnostic screen.

22.5.3 Diagnostic ISDN Line Screen

Click **Diagnostic** and then **ISDN Line** to open the screen shown next.

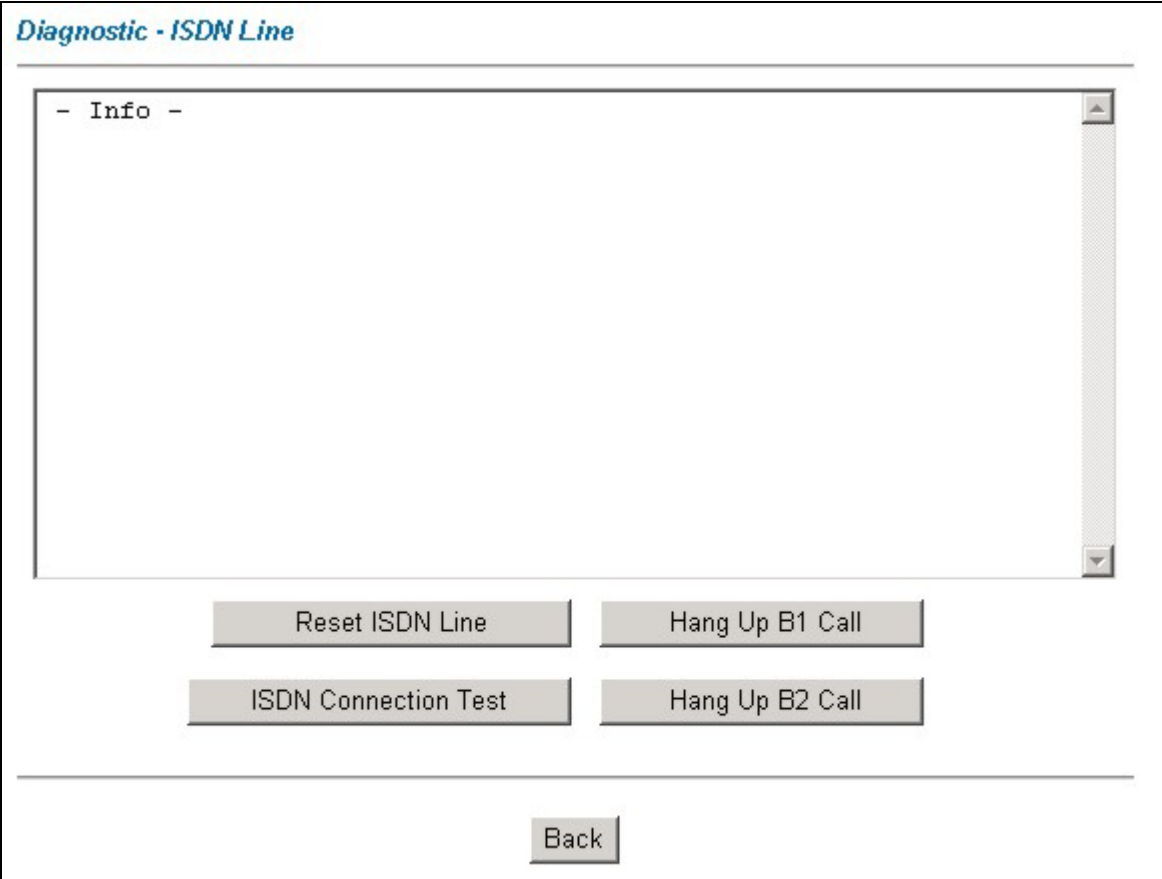

Figure 22-8 Diagnostic ISDN Line

The following table describes the fields in this screen.

Table 22-8 Diagnostic ISDN Line

LABEL	DESCRIPTION
Reset IDSN Line	This command re-initializes the ISDN link to the telephone company.

Table 22-8 Diagnostic ISDN Line

LABEL	DESCRIPTION
ISDN Connection Test	You can test to see if your ISDN line is working properly by using this option. This command triggers the Prestige to perform a loop-back test to check the functionality of the ISDN line. If the test is not successful, note the error message that you receive and consult your network administrator.
Hang Up B1 Call	This tool disconnects the B1 channel. It is only applicable if the B1 channel is currently in use.
Hang Up B2 Call	This tool disconnects the B2 channel. It is only applicable if the B2 channel is currently in use.
Back	Click this button to go back to the main Diagnostic screen.

22.6 Firmware Screen

Find firmware at www.zyxel.com in a file that (usually) uses the system model name with a "*.bin" extension, e.g., "Prestige.bin". The upload process uses FTP (File Transfer Protocol) and may take up to two minutes. After a successful upload, the system will reboot. See the *Firmware and Configuration File Maintenance* chapter in the parts that document the SMT for upgrading firmware using FTP/TFTP commands.

Only use firmware for your device's specific model. Refer to the label on the bottom of your device.

Click **Firmware** to open the following screen. Follow the instructions in this screen to upload firmware to your Prestige.

FIRMWARE

Firmware Upgrade

To upgrade the internal router firmware, browse to the location of the binary (.BIN) upgrade file and click **UPLOAD**.

File Path:

CONFIGURATION FILE

Click **Reset** to clear all user-defined configurations and return to the factory defaults.

Figure 22-9 Firmware Upgrade

The following table describes the fields in this screen.

Table 22-9 Firmware Upgrade

LABEL	DESCRIPTION
File Path	Type in the location of the file you want to upload in this field or click Browse ... to find it.
Browse...	Click Browse... to find the .bin file you want to upload. Remember that you must decompress compressed (.zip) files before you can upload them.
Upload	Click Upload to begin the upload process. This process may take up to two minutes.
Reset	Click this button to clear all user-entered configuration information and return the Prestige to its factory defaults.

Do not turn off the device while firmware upload is in progress!

After you see the **Firmware Upload in Process** screen, wait two minutes before logging into the device again.

The device automatically restarts in this time causing a temporary network disconnect. In some operating systems, you may see the following icon on your desktop.

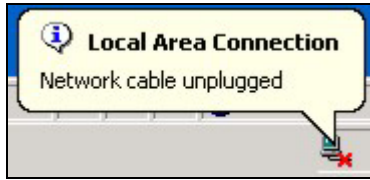

Figure 22-10 Network Temporarily Disconnected

After two minutes, log in again and check your new firmware version in the **System Status** screen.

If the upload was not successful, the following screen will appear. Click **Back** to go back to the **Firmware** screen.



Figure 22-11 Error Message

Part IX:

SMT General Configuration

This part covers System Management Terminal configuration for general setup, WAN backup, LAN setup, wireless LAN setup, Internet access, remote node, static route, NAT and enabling the firewall.

See the web configurator parts of this guide for background information on features configurable by web configurator and SMT.

Chapter 23

Introducing the SMT

This chapter explains how to access and navigate the System Management Terminal and gives an overview of its menus.

23.1 SMT Introduction

The Prestige's SMT (System Management Terminal) is a menu-driven interface that you can access from a terminal emulator through the console port or over a telnet connection. This chapter shows you how to access the SMT (System Management Terminal) menus via console port, how to navigate the SMT and how to configure SMT menus.

23.1.1 Procedure for SMT Configuration via Console Port

Follow the steps below to access your Prestige via the console port.

Configure a terminal emulation communications program as follows: VT100 terminal emulation, no parity, 8 data bits, 1 stop bit, data flow set to none, 9600 bps port speed.

Press [ENTER] to display the SMT password screen. The default password is "1234".

23.1.2 Procedure for SMT Configuration via Telnet

The following procedure details how to telnet into your Prestige.

Step 1. In Windows, click **Start** (usually in the bottom left corner), **Run** and then type "telnet 192.168.1.1" (the default IP address) and click **OK**.

Step 2. Enter "1234" in the **Password** field.

Step 3. After entering the password you will see the main menu.

Please note that if there is no activity for longer than five minutes (default timeout period) after you log in, your Prestige will automatically log you out. You will then have to telnet into the Prestige again.

23.1.3 Entering Password

The login screen appears after you press [ENTER], prompting you to enter the password, as shown next.

For your first login, enter the default password "1234". As you type the password, the screen displays an asterisk "*" for each character you type.

Please note that if there is no activity for longer than five minutes after you log in, your Prestige will automatically log you out.

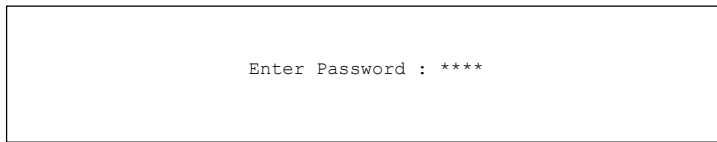

Figure 23-1 Login Screen

23.1.4 Prestige SMT Menu Overview

The following figure gives you an overview of the various SMT menu screens of your Prestige.

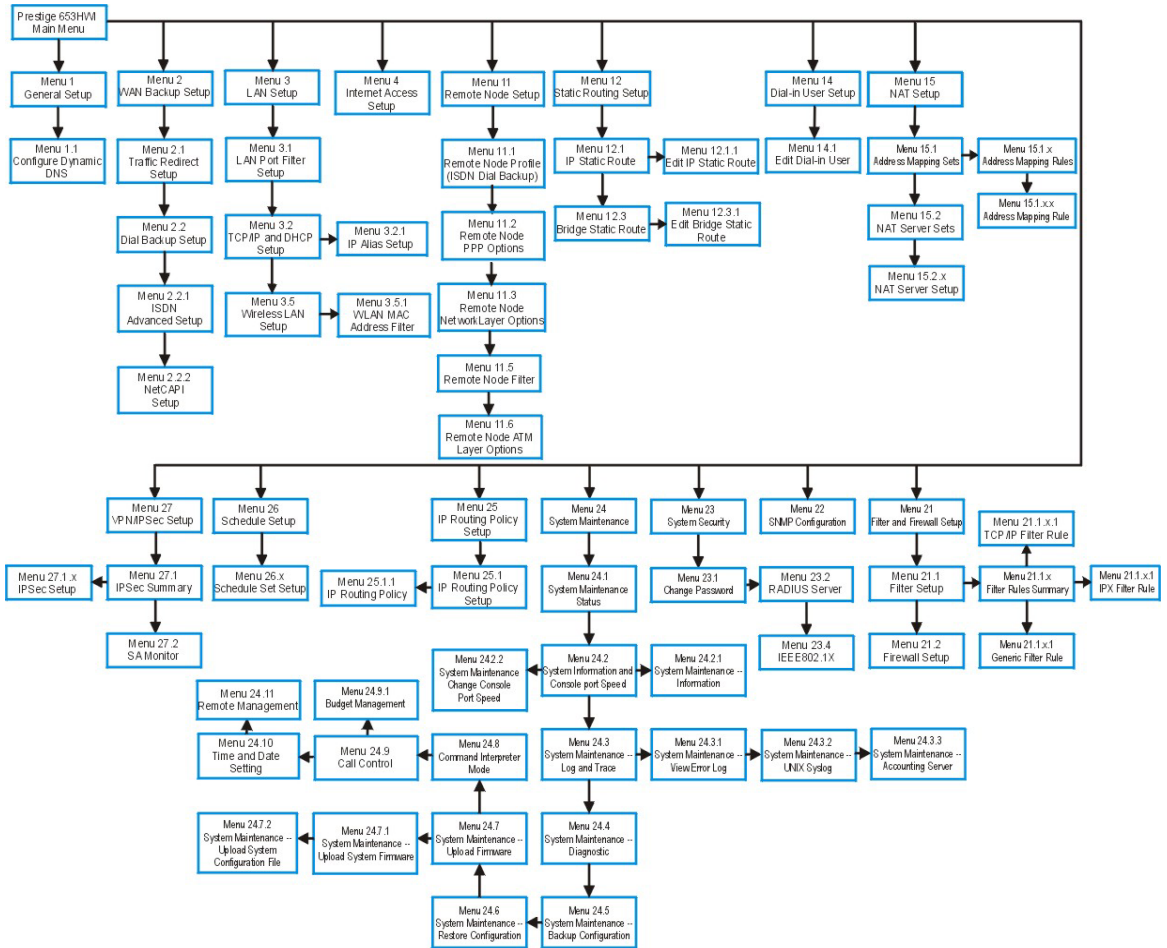

Figure 23-2 Prestige 653 SMT Menu Overview

23.2 Navigating the SMT Interface

The SMT (System Management Terminal) is the interface that you use to configure your Prestige.

Several operations that you should be familiar with before you attempt to modify the configuration are listed in the table below.

Table 23-1 Main Menu Commands

OPERATION	KEYSTROKE	DESCRIPTION
Move down to another menu	[ENTER]	To move forward to a submenu, type in the number of the desired submenu and press [ENTER].
Move up to a previous menu	[ESC]	Press [ESC] to move back to the previous menu.
Move to a "hidden" menu	Press [SPACE BAR] to change No to Yes then press [ENTER].	Fields beginning with "Edit" lead to hidden menus and have a default setting of No . Press [SPACE BAR] once to change No to Yes , then press [ENTER] to go to the "hidden" menu.
Move the cursor	[ENTER] or [UP]/[DOWN] arrow keys.	Within a menu, press [ENTER] to move to the next field. You can also use the [UP]/[DOWN] arrow keys to move to the previous and the next field, respectively.
Entering information	Type in or press [SPACE BAR], then press [ENTER].	You need to fill in two types of fields. The first requires you to type in the appropriate information. The second allows you to cycle through the available choices by pressing [SPACE BAR].
Required fields	<? > or ChangeMe	All fields with the symbol <?> must be filled in order to be able to save the new configuration. All fields with ChangeMe must not be left blank in order to be able to save the new configuration.
N/A fields	<N/A>	Some of the fields in the SMT will show a <N/A>. This symbol refers to an option that is Not Applicable.
Save your configuration	[ENTER]	Save your configuration by pressing [ENTER] at the message "Press ENTER to confirm or ESC to cancel". Saving the data on the screen will take you, in most cases to the previous menu.
Exit the SMT	Type 99, then press [ENTER].	Type 99 at the main menu prompt and press [ENTER] to exit the SMT interface.

After you enter the password, the SMT displays the main menu, as shown next.

```

Copyright (c) 1994 - 2003 ZyXEL Communications Corp.

Prestige 653HWI Main Menu

Getting Started
1. General Setup
2. WAN Backup Setup
3. LAN Setup
4. Internet Access Setup

Advanced Applications
11. Remote Node Setup
12. Static Routing Setup
14. Dial-in User Setup
15. NAT Setup

Advanced Management
21. Filter and Firewall Setup
22. SNMP Configuration
23. System Security
24. System Maintenance
25. IP Routing Policy Setup
26. Schedule Setup
27. VPN/IPSec Setup

99. Exit

Enter Menu Selection Number: _

```

Figure 23-3 SMT Main Menu

23.2.1 System Management Terminal Interface Summary

Table 23-2 Main Menu Summary

#	MENU TITLE	DESCRIPTION
1	General Setup	Use this menu to set up your general information.
2	WAN Backup Setup	Use this menu to setup traffic redirect and dial-back up.
3	LAN Setup	Use this menu to set up your wireless LAN and LAN connection.
4	Internet Access Setup	A quick and easy way to set up an Internet connection.
11	Remote Node Setup	Use this menu to set up the Remote Node for LAN-to-LAN connection, including Internet connection.
12	Static Routing Setup	Use this menu to set up static routes.
14	Dial-in User Setup	Use this menu to set up local user profiles on the Prestige.
15	NAT Setup	Use this menu to specify inside servers when NAT is enabled.
21	Filter and Firewall Setup	Use this menu to configure filters, activate/deactivate the firewall and view the firewall log.
22	SNMP Configuration	Use this menu to set up SNMP related parameters.
23	System Security	Use this menu to set up wireless security and change your password.

Table 23-2 Main Menu Summary

#	MENU TITLE	DESCRIPTION
24	System Maintenance	This menu provides system status, diagnostics, software upload, etc.
25	IP Routing Policy Setup	Use this menu to configure your IP routing policy.
26	Schedule Setup	Use this menu to schedule outgoing calls.
27	VPN/ IPSec Setup	Use this menu to configure VPN connections.
99	Exit	Use this to exit from SMT and return to a blank screen.

23.3 Changing the System Password

Change the Prestige default password by following the steps shown next.

- Step 1.** Enter 23 in the main menu to display **Menu 23 - System Security**.
- Step 2.** Enter 1 to display **Menu 23.1 - System Security - Change Password** as shown next.
- Step 3.** Type your existing system password in the **Old Password** field, for example “1234”, and press [ENTER].

```
Menu 23.1 - System Security - Change Password

Old Password= ?
New Password= ?
Retype to confirm= ?

Enter here to CONFIRM or ESC to CANCEL:
```

Figure 23-4 Menu 23 System Password

- Step 4.** Type your new system password in the **New Password** field (up to 30 characters), and press [ENTER].
- Step 5.** Re-type your new system password in the **Retype to confirm** field for confirmation and press [ENTER].

Note that as you type a password, the screen displays an “*” for each character you type.

Chapter 24

Menu 1 General Setup

Menu 1 - General Setup contains administrative and system-related information.

24.1 General Setup

Menu 1 — General Setup contains administrative and system-related information (shown next). The **System Name** field is for identification purposes. However, because some ISPs check this name you should enter your computer's "Computer Name".

- In Windows 95/98 click **Start, Settings, Control Panel, Network**. Click the **Identification** tab, note the entry for the **Computer name** field and enter it as the Prestige **System Name**.
- In Windows 2000 click **Start, Settings, Control Panel** and then double-click **System**. Click the **Network Identification** tab and then the **Properties** button. Note the entry for the **Computer name** field and enter it as the Prestige **System Name**.
- In Windows XP, click **start, My Computer, View system information** and then click the **Computer Name** tab. Note the entry in the **Full computer name** field and enter it as the Prestige **System Name**.

The **Domain Name** entry is what is propagated to the DHCP clients on the LAN. If you leave this blank, the domain name obtained by DHCP from the ISP is used. While you must enter the host name (System Name) on each individual computer, the domain name can be assigned from the Prestige via DHCP.

24.2 Procedure To Configure Menu 1

Step 1. Enter 1 in the Main Menu to open **Menu 1 — General Setup** (shown next).

```

Menu 1 - General Setup

System Name= ?
Location=
Contact Person's Name=
Domain Name=
Edit Dynamic DNS= No

Route IP= Yes
Bridge= No
Press ENTER to Confirm or ESC to Cancel:
    
```

Figure 24-1 Menu 1 General Setup

Step 2. Fill in the required fields. Refer to the table shown next for more information about these fields.

Table 24-1 Menu 1 General Setup

FIELD	DESCRIPTION	EXAMPLE
System Name	Choose a descriptive name for identification purposes. This name can be up to 30 alphanumeric characters long. Spaces are not allowed, but dashes "-" and underscores "_" are accepted.	P653
Location (optional)	Enter the geographic location (up to 31 characters) of your Prestige.	MyHouse
Contact Person's Name (optional)	Enter the name (up to 30 characters) of the person in charge of this Prestige.	JohnDoe
Domain Name	Enter the domain name (if you know it) here. If you leave this field blank, the ISP may assign a domain name via DHCP. You can go to menu 24.8 and type "sys domainname" to see the current domain name used by your gateway. If you want to clear this field just press the [SPACE BAR]. The domain name entered by you is given priority over the ISP assigned domain name.	zyxel.com.tw
Edit Dynamic DNS	Press the [SPACE BAR] to select Yes or No (default). Select Yes to configure Menu 1.1 — Configure Dynamic DNS (discussed next).	No
Route IP	Set this field to Yes to enable or No to disable IP routing. You must enable IP routing for Internet access.	Yes
Bridge	Turn on/off bridging for protocols not supported (for example, SNA) or not turned on in the previous Route IP field. Select Yes to turn bridging on; select No to turn bridging off.	No

24.2.1 Procedure to Configure Dynamic DNS

If you have a private WAN IP address, then you cannot use Dynamic DNS.

- Step 1.** To configure Dynamic DNS, go to **Menu 1 — General Setup** and select **Yes** in the **Edit Dynamic DNS** field. Press [ENTER] to display **Menu 1.1— Configure Dynamic DNS** as shown next.

```

Menu 1.1 - Configure Dynamic DNS

Service Provider = WWW.DynDNS.ORG
Active= Yes
Host= me.ddns.org
EMAIL= mail@mailserver
USER= username
Password= *****
Enable Wildcard= No

Press ENTER to confirm or ESC to cancel:

```

Figure 24-2 Menu 1.1 Configure Dynamic DNS

Follow the instructions in the next table to configure Dynamic DNS parameters.

Table 24-2 Menu 1.1 Configure Dynamic DNS

FIELD	DESCRIPTION	EXAMPLE
Service Provider	This is the name of your Dynamic DNS service provider.	WWW. DynDNS.ORG (default)
Active	Press [SPACE BAR] to select Yes and then press [ENTER] to make dynamic DNS active.	Yes
Host	Enter the domain name assigned to your Prestige by your Dynamic DNS provider.	me.dyndns.org
EMAIL	Enter your e-mail address.	mail@mailserver
USER	Enter your user name.	
Password	Enter the password assigned to you.	
Enable Wildcard	Your Prestige supports DYNDNS Wildcard. Press [SPACE BAR] and then [ENTER] to select Yes or No This field is N/A when you choose DDNS client as your service provider.	No
When you have completed this menu, press [ENTER] at the prompt "Press ENTER to Confirm..." to save your configuration, or press [ESC] at any time to cancel.		

Chapter 25

Menu 2 WAN Backup Setup

This chapter describes how to configure traffic redirect and ISDN dial-backup using menu 2, 2.2, 2.2.1, 2.2.2 and 11.1.

25.1 Introduction to WAN Backup Setup

This chapter explains how to configure the Prestige for traffic redirect and dial backup connections.

25.2 ISDN Dial Backup

To set up the ISDN port for use in the event that the regular WAN connection is dropped, first make sure you have set up the port connection and then configure:

1. Menu 2 - WAN Backup Setup
2. Menu 2.2 - ISDN Dial Backup Setup
3. Menu 2.2.1 - ISDN Advanced Backup Setup
4. Menu 2.2.2 – NetCAPI Setup
5. Menu 11.1 - Remote Node Profile

Refer also to the traffic redirect section for information on an alternate backup WAN connection.

25.3 Configuring Dial Backup in Menu 2

From the main menu, enter 2 to open menu 2.

```

Menu 2 - Wan Backup Setup

Check Mechanism = DSL Link
Check WAN IP Address1 = 0.0.0.0
Check WAN IP Address2 = 0.0.0.0
Check WAN IP Address3 = 0.0.0.0
  KeepAlive Fail Tolerance = 0
  Recovery Interval(sec) = 0
  ICMP Timeout(sec) = 0
Traffic Redirect = No
Dial Backup = No

Press ENTER to Confirm or ESC to Cancel:

Press Space Bar to Toggle.
    
```

Figure 25-1 Menu 2 WAN Backup Setup

The following table describes the fields in this menu.

Table 25-1 Menu 2 WAN Backup Setup

FIELD	DESCRIPTION
Check Mechanism	<p>Press [SPACE BAR] and then press [ENTER] to select the method that the Prestige uses to check the DSL connection.</p> <p>Select DSL Link to have the Prestige check the DSL connection's physical layer. Select ICMP to have the Prestige periodically ping the IP addresses configured in the Check WAN IP Address fields.</p>
Check WAN IP Address1-3	<p>Configure this field to test your Prestige's WAN accessibility. Type the IP address of a reliable nearby computer (for example, your ISP's DNS server address).</p> <p>When using a WAN backup connection, the Prestige periodically pings the addresses configured here and uses the other WAN backup connection (if configured) if there is no response.</p>
KeepAlive Fail Tolerance	<p>Type the number of times (2 recommended) that your Prestige may ping the IP addresses configured in the Check WAN IP Address field without getting a response before switching to a WAN backup connection (or a different WAN backup connection).</p>

Table 25-1 Menu 2 WAN Backup Setup

FIELD	DESCRIPTION
Recovery Interval(sec)	When the Prestige is using a lower priority connection (usually a WAN backup connection), it periodically checks to whether or not it can use a higher priority connection. Type the number of seconds (30 recommended) for the Prestige to wait between checks. Allow more time if your destination IP address handles lots of traffic.
ICMP Timeout	Type the number of seconds for an ICMP session to wait for the ICMP response.
Traffic Redirect	Press [SPACE BAR] to select Yes or No . Select Yes and press [ENTER] to configure Menu 2.1 Traffic Redirect Setup . Select No (default) if you do not want to configure this feature.
Dial Backup	Press [SPACE BAR] to select Yes or No . Select Yes and press [ENTER] to configure Menu 2.2 Dial Backup Setup . Select No (default) if you do not want to configure this feature.
When you have completed this menu, press [ENTER] at the prompt "Press ENTER to Confirm..." to save your configuration, or press [ESC] at any time to cancel.	

25.3.1 Traffic Redirect Setup

Configure parameters that determine when the Prestige will forward WAN traffic to the backup gateway using **Menu 2.1 — Traffic Redirect Setup**.

```

Menu 2.1 - Traffic Redirect Setup

Active= No
Configuration:
Backup Gateway IP Address= 0.0.0.0
Metric= 15

Press ENTER to Confirm or ESC to Cancel:

Press Space Bar to Toggle.

```

Figure 25-2 Menu 2.1 Traffic Redirect Setup

The following table describes the fields in this menu.

Table 25-2 Menu 2.1 Traffic Redirect Setup

FIELD	DESCRIPTION
Active	Press [SPACE BAR] and select Yes (to enable) or No (to disable) traffic redirect setup. The default is No .
Configuration:	
Backup Gateway IP Address	Enter the IP address of your backup gateway in dotted decimal notation. The Prestige automatically forwards traffic to this IP address if the Prestige's Internet connection terminates.
Metric	This field sets this route's priority among the routes the Prestige uses. The metric represents the "cost of transmission". A router determines the best route for transmission by choosing a path with the lowest "cost". RIP routing uses hop count as the measurement of cost, with a minimum of "1" for directly connected networks. The number must be between "1" and "15"; a number greater than "15" means the link is down. The smaller the number, the lower the "cost".
When you have completed this menu, press [ENTER] at the prompt "Press [ENTER] to confirm or [ESC] to cancel" to save your configuration or press [ESC] to cancel and go back to the previous screen.	

25.4 Configuring ISDN Dial Backup Setup

From the main menu, enter 2 to open menu 2. Then move the cursor to the **ISDN Dial Backup** field in **Menu 2 - WAN Backup Setup**, press the [SPACE BAR] to select **Yes** and then press [ENTER].

```

Menu 2.2 - ISDN Dial Backup Setup

Dial-Backup:
  Active= No

Switch Type: DSS-1
B Channel Usage= Switch/Switch
Incoming Phone Numbers:
  ISDN Data      =

Edit Advanced Setup = No
Edit NetCAPI Setup = No

Press ENTER to Confirm or ESC to Cancel:
    
```

Figure 25-3 Menu 2.2 IDN Dial Backup Setup

The following table describes the fields in this menu.

Table 25-3 Menu 2 ISDN Dial Backup Setup

FIELD	DESCRIPTION	
Active	Press [SPACE BAR] and select Yes (to enable) or No (to disable) dial-backup. The default is No .	
Switch Type	This read only field displays your switch type, DSS-1.	
B Channel Usage	In general, this will be Switch/Switch (default). If you are only using one B channel (e.g., your router is sharing the ISDN BRI line with another device), then select Switch/Unused . If your second B channel is a leased line, select Switch/Leased . Press [SPACE BAR] to toggle through all the options. The options are below.	
	Switch/Unused	Leased/Unused
	Switch/Switch	Unused/Leased
	Switch/Leased	Leased/Leased
Leased/Switch		
Telephone Number(s) ISDN Data	Enter the telephone number(s) assigned to your ISDN line by your telephone company. Some switch types only have one telephone number. Note that the router only accepts digits; please do not include '-' or spaces in this field. This field should be no longer than 25 digits.	
Edit Advanced Setup	Advanced Setup features are configured when you select Yes to enter Menu 2.1-ISDN Advanced Setup (see ahead). Refer to <i>section 25.5</i> for Advanced setup information.	
Edit NetAPI Setup	NetAPI Setup features are configured when you select Yes to enter Menu 2.1-ISDN NetAPI Setup (see ahead). Refer to <i>section 25.6</i> for NetAPI setup information.	
When you have completed this menu, press [ENTER] at the prompt "Press ENTER to Confirm..." to save your configuration, or press [ESC] at any time to cancel.		

25.5 ISDN Advanced Setup Menus

Select **Yes** in the **Edit Advanced Setup** field of **Menu 2 – Menu 2 WAN Backup Setup** to display Menu 2.2.1 as shown later.

Switch Type

The only switch available with your Prestige is DSS-1.

Calling Line Indication

The **Calling Line Indication**, or caller ID, determines whether the other party can see your number when you call. If set to **Enable**, the router sends the caller ID and the party you call can see your number; if it is set to **Disable**, the caller ID is blocked.

PABX Outside Line Prefix

A PABX (Private Automatic Branch eXchange) generally requires you to dial a number (a single digit in most cases) when you need an outside line. If your router is connected to a PABX, enter this number in **PABX Outside Line Prefix**, otherwise, leave it blank.

Please note that the PABX prefix is for calls initiated by the router only. If you place a call from a device on either A/B adapter, you must dial the prefix by hand.

PABX Number (with S/T Bus Number) for Loopback

Enter the S/T bus number if the router is connected to an ISDN PABX. If this field is left as blank then the ISDN loopback test will be skipped.

Outgoing Calling Party Number

If these fields are not blank, the router will use these values as the *calling party number* for "ISDN Data", "A/B Adapter 1" and "A/B Adapter 2" outgoing calls. Otherwise, the individual entries for "ISDN Data", "A/B Adapter 1" and "A/B Adapter 2" will be used as the calling party number. You only need to fill in these fields if your switch or PABX requires a specific calling party number for outgoing calls, otherwise, leave them blank.

The following diagram illustrates the **PABX Number (with S/T Bus Number) for Loopback** and **Outgoing Calling Party Number** fields for a router behind an ISDN PABX.

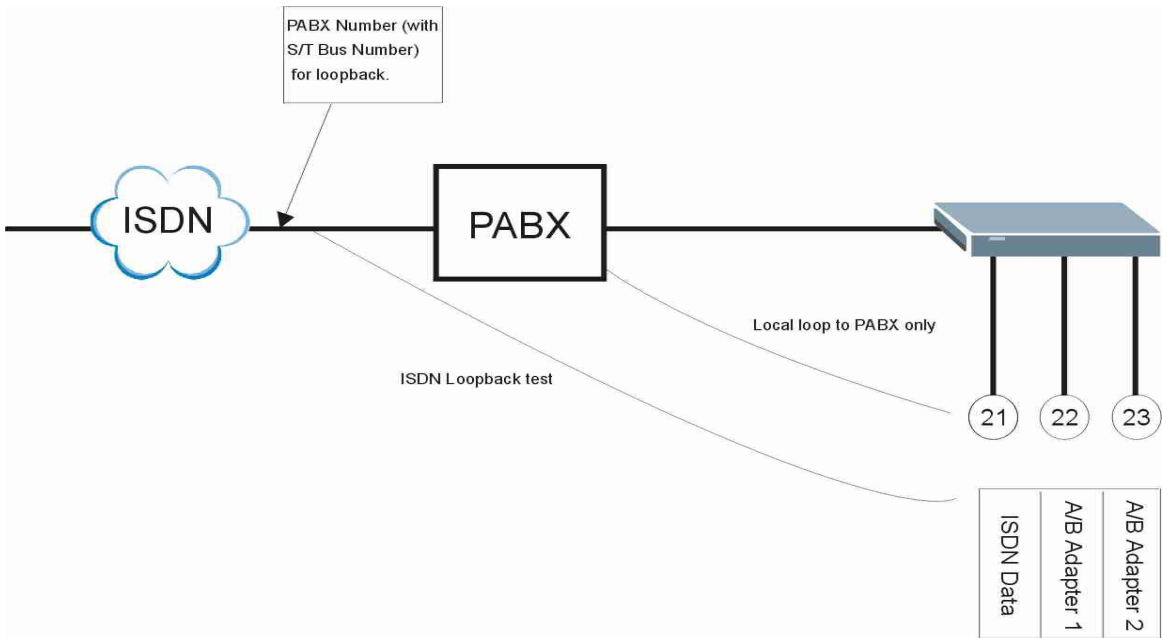

Figure 25-4 Router Behind a PABX

Data Link Connection

There are two types of ISDN Data Link Connection namely: **point-to-multipoint** and **point-to-point**. When you select point-to-multipoint, the TE1 value will be assigned by negotiation with the switch. When you select point-to-point, the TE1 value will be assigned a unique value of 0.

25.5.1 Configuring Advance Setup

```
Menu 2.2.1 - ISDN Advanced Setup

Calling Line Indication= Enable

PABX Outside Line Prefix=
PABX Number (Include S/T Bus Number) for Loopback=

Outgoing Calling Party Number:
  ISDN Data      = 80010029

Data Link Connection= point-to-multipoint

Press ENTER to Confirm or ESC to Cancel:
```

Figure 25-5 Menu 2 ISDN Setup for DSS1

When you are finished, press [ENTER] at the message: 'Press ENTER to confirm', the router uses the information that you entered to initialize the ISDN line. It should be noted that whenever the switch type is changed, the ISDN initialization takes slightly longer.

At this point, the router asks if you wish to test your ISDN. If you select **Yes**, the router will perform a loop-back test to check the ISDN line. If the loop-back test fails, please note the error message that you receive and take the appropriate troubleshooting action.

```
Setup LoopBack Test ...
Dialing to 40000// ...
Sending and Receiving Data ...
Disconnecting ...
LoopBack Test OK
### Hit any key to continue. ###
```

Figure 25-6 Loopback Test

25.6 NetCAPi Setup Menu

Select **Yes** in the **Edit NetCAPi Setup** field of **Menu 2 – Menu 2 WAN Backup Setup** to display Menu 2.2.2 as below.

```

Menu 2.2.2 - NetCAPI Setup

Active= No

Max Number of Registered Users= 1
Incoming Data Call Number Matching= Multiple Subscriber Number (MSN)

Access List:
  Start IP      End IP      Operation
  0.0.0.0      0.0.0.0    None
  0.0.0.0      0.0.0.0    None
  0.0.0.0      0.0.0.0    None
  0.0.0.0      0.0.0.0    None
  0.0.0.0      0.0.0.0    None
  0.0.0.0      0.0.0.0    None
  0.0.0.0      0.0.0.0    None
  0.0.0.0      0.0.0.0    None
  0.0.0.0      0.0.0.0    None
  default      default     None

Press ENTER to Confirm or ESC to Cancel:

```

Figure 25-7 Menu 2.2.2 NetCAPI Setup

The following table describes the fields in this menu.

Table 25-4 Menu 2.2.2 NetCAPI Setup

FIELD	DESCRIPTION
Active	Select Yes to enable NetCAPI.
Max Number of Registered Users	When you want to use NetCAPI to place outgoing calls or to listen to incoming calls, you must start RVSCOM on your computer, and RVSCOM will register itself to the Prestige. Enter the maximum number of clients that you want the Prestige to support at the same time.
Incoming Data Call Number Matching	This field determines how incoming calls are routed. Select NetCAPI if you want to direct all incoming data calls to NetCAPI. Select Subscriber Number (MSN) if you want to direct incoming calls to the Prestige only when the incoming phone number matches the ISDN DATA number. If the incoming phone number does not match the ISDN DATA number, then the call will be routed to NetCAPI. Select Called Party Subaddress if you want to direct all incoming calls to the Prestige only when the incoming call matches the subaddress of ISDN DATA. If the incoming call does not match the subaddress of ISDN DATA, then the call will be routed to NetCAPI.
Access List:	This access list controls if a client is allowed to use NetCAPI. The request is rejected when either the IP address of the computer is not between Start IP and End IP or the request from the computer is not permitted as specified in the Operation field.

Table 25-4 Menu 2.2.2 NetCAPI Setup

FIELD	DESCRIPTION
Start IP	Refers to the first IP address of a group of NetCAPI clients. Each group contains contiguous IP addresses.
End IP	Refers to the last IP address in a NetCAPI client group.
Operation	Select Incoming if you wish to grant incoming calls permission. Select Outgoing if you wish to grant outgoing calls permission. Select Both if you wish to grant both incoming calls and outgoing calls permissions. Select None if you wish to deny all calls.
When you have completed this menu, press [ENTER] at the prompt "Press ENTER to Confirm..." to save your configuration, or press [ESC] at any time to cancel.	

25.7 ISDN Remote Node Profile

Should the ADSL become unavailable, the Remote Node Profile **9** settings are used for a backup ISDN connection. Remote Node Profile **10** enables Dial-In access to the Prestige for remote management. Enter **9** or **10** in **Menu 11 Remote Node Setup** to open **Menu 11.1 ISDN Remote Node Profile** (shown below) and configure the setup for your dial backup or dial-in port connection.

```

Menu 11.1 - ISDN Remote Node Profile

Rem Node Name= ?           Edit PPP Options= No
Active= Yes                Rem IP Addr= ?
Call Direction= Outgoing  Edit IP= No

Incoming:                  Telco Option:
  Rem Login= N/A           Transfer Type= 64K
  Rem Password= N/A       Allocated Budget (min)=
  Rem CLID= N/A           Period(hr)=
  Call Back= N/A          Schedules=
Outgoing:                  Carrier Access Code=
  My Login=                Nailed-Up Connection= No
  My Password= *****    Toll Period(sec)= 0
  Authen= CHAP/PAP        Session Options:
  Pri Phone #= ?          Edit Filter Sets= No
  Sec Phone #=            Idle Timeout(sec)= 300

Press ENTER to Confirm or ESC to Cancel:
    
```

Figure 25-8 Menu 11.1 ISDN Remote Node Profile

The following table describes the fields in this menu.

Table 25-5 Menu 11.1 ISDN Remote Node Profile

FIELD	DESCRIPTION	EXAMPLE
Rem Node Name	Enter a descriptive name for the remote node. This field can be up to eight characters.	BackupISP
Active	Press [SPACE BAR] and then [ENTER] to select Yes to activate or No to deactivate this node. Inactive nodes are displayed with a minus sign “-“ in SMT menu 11.	Yes
Call Direction	Press [SPACE BAR] and then [ENTER] to select the Call Direction . Options are Both , Outgoing or Incoming .	Outgoing
Incoming	Fields are disabled when the Call Direction is set to Outgoing .	
Rem Login	Type the login name that this remote node will use to call your Prestige. The login name and the Rem Password will be used to authenticate this node.	
Rem Password	Type the password used when this remote node calls your Prestige.	*****
Outgoing	Fields are disabled when the Call Direction is set to Incoming .	
My Login	Configure the My Login and My Password fields for PPPoA and PPPoE encapsulation only. Enter the login name that your ISP gives you. If you are using PPPoE encapsulation, then this field must be of the form user@domain where domain identifies your PPPoE service name.	N/A
My Password	Enter the password associated with the login name above.	*****
Authen	This field sets the authentication protocol used for outgoing calls. Options for this field are: CHAP/PAP - Your Prestige will accept either CHAP or PAP when requested by this remote node. CHAP - accept CHAP only. PAP - accept PAP only.	CHAP/PAP
Pri Phone # Sec Phone #	Enter the first (primary) phone number from the ISP for this remote node. If the Primary Phone number is busy or does not answer, your Prestige dials the Secondary Phone number if available. Some areas require dialing the pound sign # before the phone number for local calls. Include a # symbol at the beginning of the phone numbers as required.	
Edit PPP Options	Move the cursor to this field and use the space bar to select [Yes] and press [Enter] to edit the PPP options for this remote node. This brings you to Menu 11.2 - Remote Node PPP Options (see <i>section 25.8</i>).	No (default)

Table 25-5 Menu 11.1 ISDN Remote Node Profile

FIELD	DESCRIPTION	EXAMPLE
Rem IP Addr	Leave the field set to 0.0.0.0 (default) if the remote gateway has a dynamic IP address. Enter the remote gateway's IP address here if it is static.	0.0.0.0 (default)
Edit IP	This field leads to a "hidden" menu. Press [SPACE BAR] to select Yes and press [ENTER] to go to Menu 11.3 - Remote Node Network Layer Options . See <i>section 25.9</i> for more information.	No (default)
Edit Script Options	Press [SPACE BAR] to select Yes and press [ENTER] to edit the AT script for the dial backup remote node (Menu 11.4 - Remote Node Script). See <i>section 25.10</i> for more information.	No (default)
Telco Option		
Allocated Budget	Enter the maximum number of minutes that this remote node may be called within the time period configured in the Period field. The default for this field is 0 meaning there is no budget control and no time limit for accessing this remote node.	0 (default)
Period(hr)	Enter the time period (in hours) for how often the budget should be reset. For example, to allow calls to this remote node for a maximum of 10 minutes every hour, set the Allocated Budget to 10 (minutes) and the Period to 1 (hour).	0 (default)
Nailed-Up Connection	Press [SPACE BAR] to select Yes to set this connection to always be on, regardless of whether or not there is any traffic. Select No to have this connection act as a dial-up connection.	No (default)
Session Options		
Edit Filter sets	This field leads to another "hidden" menu. Use [SPACE BAR] to select Yes and press [ENTER] to open menu 11.5 to edit the filter sets. See <i>section 25.11</i> for more details.	No (default)
Idle Timeout	Enter the number of seconds of idle time (when there is no traffic from the Prestige to the remote node) that can elapse before the Prestige automatically disconnects the PPP connection. This option only applies when the Prestige initiates the call.	100 seconds (default)
Once you have configured this menu, press [ENTER] at the message "Press ENTER to Confirm..." to save your configuration, or press [ESC] at any time to cancel.		

25.8 Editing PPP Options

The Prestige's dial back-up feature uses PPP. To edit the remote node PPP Options, move the cursor to the **Edit PPP Options** field in **Menu 11.1 - Remote Node Profile (Backup ISP)**, and use the space bar to select **[Yes]**. Press **[Enter]** to open menu 11.2 as shown next.

```

Menu 11.2 - Remote Node PPP Options

Encapsulation= Standard PPP
Compression= No
BACP= Enable

Multiple Link Options:
  BOD Calculation= Transmit or Receive
  Base Trans Rate(Kbps)= 64
  Max Trans Rate(Kbps)= 128
  Target Utility(Kbps)= 32-48

Press Space Bar to Toggle.
    
```

Figure 25-9 Menu 11.2 Remote Node PPP Options

This table describes the Remote Node PPP Options Menu, and contains instructions on how to configure the PPP options fields.

Table 25-6 Menu 11.2 Remote Node PPP Options

FIELD	DESCRIPTION	EXAMPLE
Encapsulation	Press [SPACE BAR] and then [ENTER] to select CISCO PPP if your Dial Backup WAN device uses Cisco PPP encapsulation, otherwise select Standard PPP .	Standard PPP (default)
Compression	Press [SPACE BAR] and then [ENTER] to select Yes to enable or No to disable Stac compression.	No (default)
BACP	Your Prestige negotiates the Secondary Phone number for a dial-up line from the peer when BACP (Bandwidth Allocation Control Protocol) is enabled; otherwise it uses the Secondary Phone number set in Menu 11.1.	Enable (default)
Multiple Link Options:		
BOD Calculation	Select the direction of the traffic you wish to use in determining when to add or subtract a link. Options for this field are: Transmit or Receive, Transmit, Receive .	Transmit or Receive (default)

Table 25-6 Menu 11.2 Remote Node PPP Options

Base Trans Rate(Kbps)	Select the base data transfer rate for this remote node in kilobits per second. There are two choices for this field: 64 where only one channel is used or, 128 where two channels are used as soon as a packet triggers a call.	64
Max Trans Rate(Kbps)	Enter the maximum data transfer rate allowed for this remote node. This parameter is in kilobits per second.	64
Target Utility(Kbps)	Enter the two thresholds separated by a [-] for subtracting and adding the second port.	Default = 32-48

25.9 Editing TCP/IP Options

Move the cursor to the **Edit IP** field in **Menu 11.1 - Remote Node Profile (Backup ISP)**, then press [SPACE BAR] to select **Yes**. Press [ENTER] to open **Menu 11.3 - Network Layer Options**.

```

Menu 11.3 - Remote Node Network Layer Options

IP Options:                               Bridge Options:
IP Address Assignment = Dynamic           Ethernet Addr Timeout(min)= N/A
Rem IP Addr = 0.0.0.0
Rem Subnet Mask= 0.0.0.0
My WAN Addr= N/A
NAT= Full Feature
    Address Mapping Set= 1
Metric= 2
Private= No
RIP Direction= None
    Version= RIP-1
Multicast= None
IP Policies=

Enter here to CONFIRM or ESC to CANCEL:

```

Figure 25-10 Menu 11.3 Remote Node Network Layer Options

The following table describes the fields in this menu.

Table 25-7 Menu 11.2 Remote Node PPP Options

FIELD	DESCRIPTION	EXAMPLE
IP Address Assignment	Press [SPACE BAR] and then [ENTER] to select Dynamic if the remote node is using a dynamically assigned IP address or Static if it is using a static (fixed) IP address. You will only be able to configure this in the ISP node (also the one you configure in menu 4), all other nodes are set to Static .	Dynamic
Rem IP Addr	This is the IP address you entered in the previous menu.	
Rem Subnet Mask	Type the subnet mask assigned to the remote node.	255.255.255.0
My WAN Addr	Some implementations, especially UNIX derivatives, require separate IP network numbers for the WAN and LAN links and each end to have a unique address within the WAN network number. In that case, type the IP address assigned to the WAN port of your Prestige. NOTE: Refers to local Prestige address, not the remote router address.	
NAT	Press [SPACE BAR] and then [ENTER] to select Full Feature if you have multiple public WAN IP addresses for your Prestige. Select SUA Only if you have just one public WAN IP address for your Prestige. The SMT uses Address Mapping Set 255 (menu 15.1 - see section 32.3.1). Select None to disable NAT.	SUA Only
Address Mapping Set	When Full Feature is selected in the NAT field, configure address mapping sets in menu 15.1. Select one of the NAT server sets (2-10) in menu 15.2 (see the <i>NAT</i> chapter for details) and type that number here. When SUA Only is selected in the NAT field, the SMT uses NAT server set 1 in menu 15.2 (see the <i>NAT</i> chapter for details).	2
Metric	The metric represents the "cost" of transmission for routing purposes. IP routing uses hop count as the cost measurement, with a minimum of 1 for directly connected networks. Type a number that approximates the cost for this link. The number need not be precise, but it must be between 1 and 15. In practice, 2 or 3 is usually a good number.	2
Private	This determines if the Prestige will include the route to this remote node in its RIP broadcasts. If set to Yes , this route is kept private and not included in RIP broadcast. If No , the route to this remote node will be propagated to other hosts through RIP broadcasts.	No

Table 25-7 Menu 11.2 Remote Node PPP Options

RIP Direction	Press [SPACE BAR] and then [ENTER] to select the RIP Direction. Options are Both , In Only , Out Only or None .	None
Version	Press [SPACE BAR] and then [ENTER] to select the RIP version. Options are RIP-1 , RIP-2B or RIP-2M .	RIP-1
Multicast	IGMP-v1 sets IGMP to version 1, IGMP-v2 sets IGMP to version 2 and None disables IGMP.	None
IP Policies	You can apply up to four IP Policy sets (from 12) by typing in their numbers separated by commas. Configure the filter sets in menu 25 first (see the <i>IP Policy Routing</i> chapter) and then apply them here.	3, 4, 5, 6
When you have completed this menu, press [ENTER] at the prompt "Press ENTER to confirm or ESC to cancel" to save your configuration or press [ESC] to cancel and go back to the previous screen.		

25.10 Editing Login Script

For some remote gateways, text login is required before PPP negotiation is started. The Prestige provides a script facility for this purpose. The script has six programmable sets; each set is composed of an 'Expect' string and a 'Send' string. After matching a message from the server to the 'Expect' field, the Prestige returns the set's 'Send' string to the server.

For instance, a typical login sequence starts with the server printing a banner, a login prompt for you to enter the user name and a password prompt to enter the password:

```
Welcome to Acme, Inc.

Login: myLogin

Password:
```

To handle the first prompt, you specify "ogin: " as the 'Expect' string and "myLogin" as the 'Send' string in set 1. The reason for leaving out the leading "L" is to avoid having to know exactly whether it is upper or lower case. Similarly, you specify "word: " as the 'Expect' string and your password as the 'Send' string for the second prompt in set 2.

You can use two variables, \$USERNAME and \$PASSWORD (all UPPER case), to represent the actual user name and password in the script, so they will not show in the clear. They are replaced with the outgoing login name and password in the remote node when the Prestige sees them in a 'Send' string. Please note that both variables must be entered exactly as shown. No other characters may appear before or after, either, i.e., they must be used alone in response to login and password prompts.

Please note that the ordering of the sets is significant, i.e., starting from set 1, the Prestige will wait until the 'Expect' string is matched before it proceeds to set 2, and so on for the rest of the script. When both the

'Expect' and the 'Send' fields of the current set are empty, the Prestige will terminate the script processing and start PPP negotiation. This implies two things: first, the sets must be contiguous; the sets after an empty one are ignored. Second, the last set should match the final message sent by the server. For instance, if the server prints:

```
login successful.
Starting PPP...
```

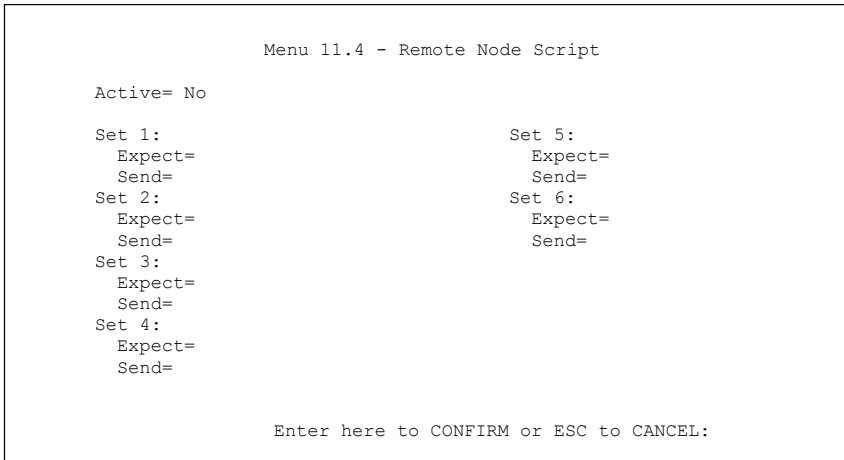

After you enter the password, then you should create a third set to match the final "PPP . . ." but without a "Send" string. Otherwise, the Prestige will start PPP prematurely right after sending your password to the server.

If there are errors in the script and it gets stuck at a set for longer than the "Dial Timeout" in menu 2 (default 60 seconds), the Prestige will timeout and drop the line. To debug a script, go to Menu 24.4 to initiate a manual call and watch the trace display to see if the sequence of messages and prompts from the server differs from what you expect.

Figure 25-11 Menu 11.4 Remote Node Setup Script

The following table describes the fields in this menu.

Table 25-8 Menu 11.4 Remote Node Setup Script

FIELD	DESCRIPTION	EXAMPLE
Active	Press [SPACE BAR] and then [ENTER] to select either Yes to enable the AT strings or No to disable them.	No (default)

Table 25-8 Menu 11.4 Remote Node Setup Script

Set 1-6: Expect	Enter an Expect string to match. After matching the Expect string, the Prestige returns the string in the Send field.	
Set 1-6: Send	Enter a string to send out after the Expect string is matched.	0.0.0.0

25.11 Remote Node Filter

Move the cursor to the field **Edit Filter Sets** in **Menu 11.1 - Remote Node Profile (Backup ISP)**, and then press [SPACE BAR] to set the value to **Yes**. Press [ENTER] to open **Menu 11.5 - Remote Node Filter**.

```

Menu 11.1 - Remote Node Profile (Backup ISP)

Rem Node Name= ?           Edit PPP Options= No
Active= Yes                Rem IP Addr= ?
                            Edit IP= No
                            Edit Script Options= No
Outgoing:
  My Login=                Telco Option:
  My Password= *****    Allocated Budget (min)= 0
  Authen= CHAP/PAP        Period(hr)= 0
  Pri Phone #= ?          Nailed-Up Connection= No
  Sec Phone #=

                            Session Options:
                            Edit Filter Sets= Yes
                            Idle Timeout(sec)= 100

Press ENTER to Confirm or ESC to Cancel:

```

Figure 25-12 Menu 11.1 Remote Node Profile (Backup ISP)

Use menu 11.5 to specify the filter set(s) to apply to the incoming and outgoing traffic between this remote node and the Prestige to prevent certain packets from triggering calls. You can specify up to four filter sets separated by commas, for example, 1, 5, 9, 12, in each filter field. Note that spaces are accepted in this field. Please refer to the *Filters* chapter for more information on defining the filters.

```
Menu 11.5 - Remote Node Filter

Input Filter Sets:
  protocol filters=
  device filters=
Output Filter Sets:
  protocol filters=
  device filters=
Call Filter Sets:
  protocol filters=
  device filters=

Enter here to CONFIRM or ESC to CANCEL:
```

Figure 25-13 Menu 11.5 Dial Backup Remote Node Filter

Chapter 26

Menu 3 LAN Setup

This chapter covers how to configure your wired Local Area Network (LAN) settings.

26.1 LAN Setup

This section describes how to configure the Ethernet using **Menu 3 — LAN Setup**. From the main menu, enter 3 to display menu 3.

```
Menu 3 - LAN Setup

1. LAN Port Filter Setup
2. TCP/IP and DHCP Setup

5. Wireless LAN Setup

Enter Menu Selection Number:
```

Figure 26-1 Menu 3 LAN Setup

26.1.1 General Ethernet Setup

This menu allows you to specify filter set(s) that you wish to apply to the Ethernet traffic. You seldom need to filter Ethernet traffic; however, the filter sets may be useful to block certain packets, reduce traffic and prevent security breaches.

```
Menu 3.1 - LAN Port Filter Setup

Input Filter Sets:
protocol filters=
device filters=
Output Filter Sets:
protocol filters=
device filters=

Press ENTER to Confirm or ESC to Cancel:
```

Figure 26-2 Menu 3.1 LAN Port Filter Setup

If you need to define filters, please read the *Filter Set Configuration* chapter first, then return to this menu to define the filter sets.

26.2 Protocol Dependent Ethernet Setup

Depending on the protocols for your applications, you need to configure the respective Ethernet Setup, as outlined below.

- For TCP/IP Ethernet setup refer to the *Internet Access Application* chapter.
- For bridging Ethernet setup refer to the *Bridging Setup* chapter.

26.3 TCP/IP Ethernet Setup and DHCP

Use menu 3.2 to configure your Prestige for TCP/IP.

To edit menu 3.2, enter 3 from the main menu to display **Menu 3 — Ethernet Setup**. When menu 3 appears, press 2 and press [ENTER] to display **Menu 3.2 — TCP/IP and DHCP Ethernet Setup**, as shown next:

The screenshot shows the configuration menu for TCP/IP and DHCP. The DHCP Setup section includes fields for Server, Client IP Pool (Starting Address, Size), and DNS Servers. The TCP/IP Setup section includes fields for IP Address, Subnet Mask, RIP Direction, Version, Multicast, Policies, and IP Alias. Callouts on the right side of the image point to specific values: '192.168.1.33' is the first address in the IP pool; '32' is the size of the IP pool; '0.0.0.0' is the IP address of a DNS server; and '192.68.1.1' is the IP address of the Prestige device.

```

Menu 3.2 - TCP/IP and DHCP Ethernet Setup

DHCP Setup:
  DHCP= Server
  Client IP Pool Starting Address= 192.168.1.33
  Size of Client IP Pool= 32
  Primary DNS Server= 0.0.0.0
  Secondary DNS Server= 0.0.0.0
  Remote DHCP Server= N/A

TCP/IP Setup:
  IP Address= 192.68.1.1
  IP Subnet Mask= 255.255.255.0
  RIP Direction= Both
    Version= RIP-1
  Multicast= None
  IP Policies=
  Edit IP Alias= No

Press ENTER to Confirm or ESC to Cancel:

Press Space Bar to Toggle.
    
```

Figure 26-3 Menu 3.2 TCP/IP and DHCP Ethernet Setup

Follow the instructions in the following table on how to configure the DHCP fields.

Table 26-1 DHCP Ethernet Setup Menu Fields

FIELD	DESCRIPTION	EXAMPLE
DHCP Setup		
DHCP	<p>If set to Server, your Prestige can assign IP addresses, an IP default gateway and DNS servers to Windows 95, Windows NT and other systems that support the DHCP client.</p> <p>If set to None, the DHCP server will be disabled.</p> <p>If set to Relay, the Prestige acts as a surrogate DHCP server and relays DHCP requests and responses between the remote server and the clients. Enter the IP address of the actual, remote DHCP server in the Remote DHCP Server in this case.</p> <p>When DHCP is used, the following items need to be set:</p>	Server (default)
Client IP Pool Starting Address	This field specifies the first of the contiguous addresses in the IP address pool.	192.168.1.33
Size of Client IP Pool	This field specifies the size or count of the IP address pool.	32
Primary DNS Server Secondary DNS Server	Enter the IP addresses of the DNS servers. The DNS servers are passed to the DHCP clients along with the IP address and the subnet mask.	
Remote DHCP Server	If Relay is selected in the DHCP field above then enter the IP address of the actual remote DHCP server here.	

Follow the instructions in the following table to configure TCP/IP parameters for the Ethernet port.

Table 26-2 TCP/IP Ethernet Setup Menu Fields

FIELD	DESCRIPTION	EXAMPLE
TCP/IP Setup		
IP Address	Enter the (LAN) IP address of your Prestige in dotted decimal notation	192.168.1.1
IP Subnet Mask	Your Prestige will automatically calculate the subnet mask based on the IP address that you assign. Unless you are implementing subnetting, use the subnet mask computed by the Prestige.	255.255.255.0
RIP Direction	Press [SPACE BAR] to select the RIP direction. Choices are Both , In Only , Out Only or None .	Both (default)
Version	Press [SPACE BAR] to select the RIP version. Choices are RIP-1 , RIP-2B or RIP-2M .	RIP-1 (default)

Table 26-2 TCP/IP Ethernet Setup Menu Fields

FIELD	DESCRIPTION	EXAMPLE
Multicast	IGMP (Internet Group Multicast Protocol) is a network-layer protocol used to establish membership in a Multicast group. The Prestige supports both IGMP version 1 (IGMP-v1) and version 2 (IGMP-v2). Press the [SPACE BAR] to enable IP Multicasting or select None to disable it.	None (default)
IP Policies	Create policies using SMT menu 25 (see the <i>IP Policy Routing chapter</i>) and apply them on the Prestige LAN interface here. You can apply up to four IP Policy sets (from twelve) by entering their numbers separated by commas.	2,4,7,9
Edit IP Alias	The Prestige supports three logical LAN interfaces via its single physical Ethernet interface with the Prestige itself as the gateway for each LAN network. Press [SPACE BAR] to change No to Yes and press [ENTER] to for menu 3.2.1	No (default)

Chapter 27

Wireless LAN Setup

This chapter covers how to configure wireless LAN settings in SMT menu 3.5

27.1 Wireless LAN Overview

Refer to the chapter on the wireless LAN screens for wireless LAN background information. For PCMCIA Wireless LAN Card installation, refer to the Compact Guide.

27.2 Wireless LAN Setup

Use menu 3.5 to set up your Prestige as the wireless access point. To edit menu 3.5, enter 3 from the main menu to display **Menu 3 – LAN Setup**. When menu 3 appears, press 5 and then press [ENTER] to display **Menu 3.5 – Wireless LAN Setup** as shown next.

```
Menu 3.5- Wireless LAN Setup

ESSID= Wireless
Hide ESSIS = No
Channel ID= CH01 2412MHz
RTS Threshold= 2432
Frag. Threshold= 2432
WEP= Disable
    Default Key= N/A
    Key1= N/A
    Key2= N/A
    Key3= N/A
    Key4= N/A
Edit MAC Address Filter= No

Press ENTER to Confirm or ESC to Cancel:
```

Figure 27-1 Menu 3.5 - Wireless LAN Setup

The following table describes the fields in this menu.

Table 27-1 Menu 3.5 - Wireless LAN Setup

FIELD	DESCRIPTION	EXAMPLE
ESSID	The ESSID (Extended Service Set Identifier) identifies the service set the wireless station is to connect to. Wireless stations associating to the Access Point must have the same ESSID. Enter a descriptive name up to 32 printable 7-bit ASCII characters.	Wireless
Hide ESSID	Press [SPACE BAR] and select Yes to hide the ESSID in the outgoing beacon frame so a station cannot obtain the ESSID through passive scanning.	No
Channel ID	Press [SPACE BAR] to select a channel. This allows you to set the operating frequency/channel depending on your particular region.	CH01 2412MHz
RTS Threshold	RTS(Request To Send) threshold (number of bytes) enables RTS/CTS handshake. Data with its frame size larger than this value will perform the RTS/CTS handshake. Setting this attribute to be larger than the maximum MSDU (MAC Service Data Unit) size turns off the RTS/CTS handshake. Setting this attribute to zero turns on the RTS/CTS handshake. Enter a value between 0 and 2432.	2432
Frag. Threshold	The threshold (number of bytes) for the fragmentation boundary for directed messages. It is the maximum data fragment size that can be sent. Enter a value between 256 and 2432.	2432
WEP	WEP (Wired Equivalent Privacy) provides data encryption to prevent wireless stations from accessing data transmitted over the wireless network. Select Disable allows wireless stations to communicate with the access points without any data encryption. Select 64-bit WEP or 128-bit WEP to for the type of data encryption. WEP causes performance degradation.	Disable
Default Key	Enter the number of the key as an active key.	
Key 1 to Key 4	If you chose 64-bit WEP in the WEP Encryption field, then enter 5 characters or 10 hexadecimal characters ("0-9", "A-F") preceded by 0x for each key (1-4). If you chose 128-bit WEP in the WEP Encryption field, then enter 13 characters or 26 hexadecimal characters ("0-9", "A-F") preceded by 0x for each key (1-4). There are four data encryption keys to secure your data from eavesdropping by unauthorized wireless users. The values for the keys must be set up exactly the same on the access points as they are on the wireless stations.	
Edit MAC Address Filter	To edit MAC address filtering table, press [SPACE BAR] to select Yes and press [ENTER] to open menu 3.5.1.	No

Table 27-1 Menu 3.5 - Wireless LAN Setup

FIELD	DESCRIPTION	EXAMPLE
When you have completed this menu, press [ENTER] at the prompt "Press ENTER to confirm or ESC to cancel" to save your configuration or press [ESC] to cancel and go back to the previous screen.		

27.2.1 Wireless LAN MAC Address Filter

The next layer of security is MAC address filter. To allow a wireless station to associate with the Prestige, enter the MAC address of the wireless LAN card on that wireless station in the MAC address table.

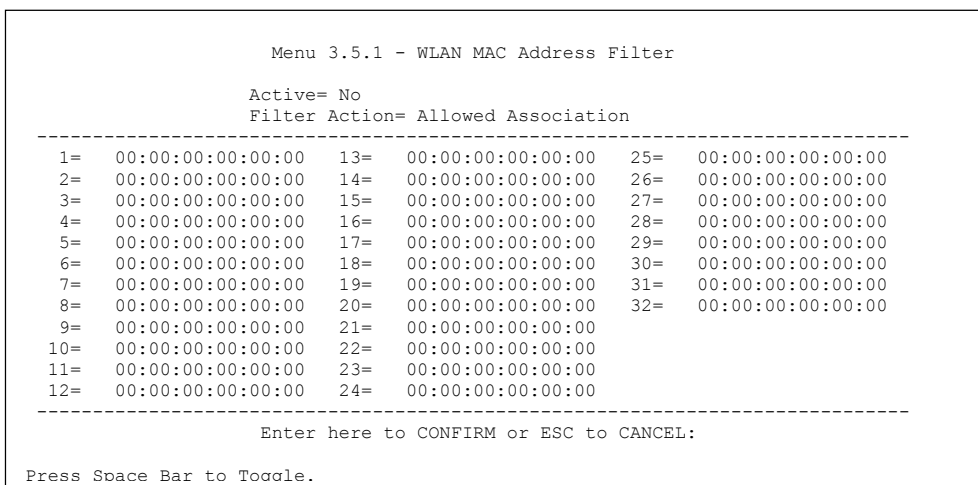

Figure 27-2 Menu 3.5.1 WLAN MAC Address Filtering

The following table describes the fields in this menu.

Table 27-2 Menu 3.5.1 WLAN MAC Address Filtering

FIELD	DESCRIPTION
Active	To enable MAC address filtering, press [SPACE BAR] to select Yes and press [ENTER].
Filter Action	Define the filter action for the list of MAC addresses in the MAC address filter table. To deny access to the Prestige, press [SPACE BAR] to select Deny Association and

Table 27-2 Menu 3.5.1 WLAN MAC Address Filtering

FIELD	DESCRIPTION
Filter Action	<p>Define the filter action for the list of MAC addresses in the MAC address filter table.</p> <p>To deny access to the Prestige, press [SPACE BAR] to select Deny Association and press [ENTER]. MAC addresses not listed will be allowed to access the router.</p> <p>The default action, Allowed Association, permits association with the Prestige. MAC addresses not listed will be denied access to the router.</p>
MAC Address Filter	
Address 1....	Enter the MAC addresses (in XX:XX:XX:XX:XX:XX format) of the wireless stations that are allowed or denied access to the Prestige in these address fields.
When you have completed this menu, press [ENTER] at the prompt "Press ENTER to confirm or ESC to cancel" to save your configuration or press [ESC] to cancel and go back to the previous screen.	

Chapter 28

Internet Access

This chapter shows you how to configure the LAN and WAN of your Prestige for Internet access.

28.1 Internet Access Overview

Refer to the chapters on the web configurator's wizard, LAN and WAN screens for more background information on fields in the SMT screens covered in this chapter.

28.2 IP Policies

Traditionally, routing is based on the destination address *only* and the router takes the shortest path to forward a packet. IP Policy Routing (IPPR) provides a mechanism to override the default routing behavior and alter the packet forwarding based on the policy defined by the network administrator. Policy-based routing is applied to incoming packets on a per interface basis, prior to the normal routing. Create policies using SMT menu 25 (see *IP Policy Routing*) and apply them on the Prestige LAN and/or WAN interfaces using menus 3.2 (LAN) and 11.3 (WAN).

28.3 IP Alias

IP Alias allows you to partition a physical network into different logical networks over the same Ethernet interface. The Prestige supports three logical LAN interfaces via its single physical Ethernet interface with the Prestige itself as the gateway for each LAN network.

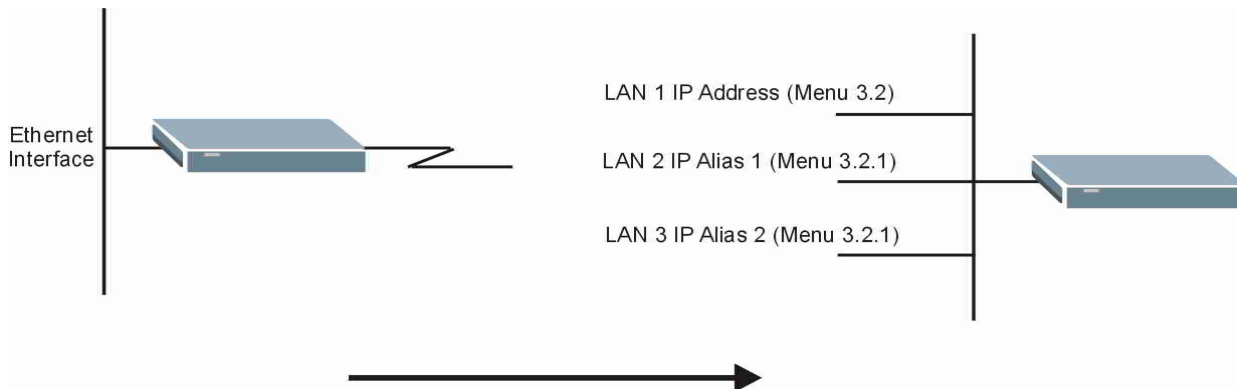

Figure 28-1 Physical Network

Figure 28-2 Partitioned Logical Networks

Use menu 3.2.1 to configure IP Alias on your Prestige.

28.4 IP Alias Setup

Use menu 3.2 to configure the first network. Move the cursor to **Edit IP Alias** field and press [SPACEBAR] to choose **Yes** and press [ENTER] to configure the second and third network.

```
Menu 3.2 - TCP/IP and DHCP Setup

DHCP Setup:
  DHCP= Server
  Client IP Pool Starting Address= 192.168.1.33
  Size of Client IP Pool= 32
  Primary DNS Server= 0.0.0.0
  Secondary DNS Server= 0.0.0.0
  Remote DHCP Server= N/A
TCP/IP Setup:
  IP Address= 192.168.1.1
  IP Subnet Mask= 255.255.255.0
  RIP Direction= None
  Version= N/A
  Multicast= None
  IP Policies=
  Edit IP Alias= Yes

Press ENTER to confirm or ESC to Cancel:

Press Space Bar to Toggle.
```

Figure 28-3 Menu 3.2 TCP/IP and DHCP Setup

Pressing [ENTER] displays **Menu 3.2.1 — IP Alias Setup**, as shown next.

```
Menu 3.2.1 - IP Alias Setup

IP Alias 1= No
  IP Address= N/A
  IP Subnet Mask= N/A
  RIP Direction= N/A
  Version= N/A
  Incoming protocol filters= N/A
  Outgoing protocol filters= N/A
IP Alias 2= No
  IP Address= N/A
  IP Subnet Mask= N/A
  RIP Direction= N/A
  Version= N/A
  Incoming protocol filters= N/A
  Outgoing protocol filters= N/A

Enter here to CONFIRM or ESC to CANCEL:
```

Figure 28-4 Menu 3.2.1 IP Alias Setup

Follow the instructions in the following table to configure IP Alias parameters.

Table 28-1 Menu 3.2.1 IP Alias Setup

FIELD	DESCRIPTION	EXAMPLE
IP Alias	Choose Yes to configure the LAN network for the Prestige.	Yes
IP Address	Enter the IP address of your Prestige in dotted decimal notation	192.168.2.1
IP Subnet Mask	Your Prestige will automatically calculate the subnet mask based on the IP address that you assign. Unless you are implementing subnetting, use the subnet mask computed by the Prestige	255.255.255.0
RIP Direction	Press [SPACE BAR] to select the RIP direction. Choices are None , Both , In Only or Out Only .	None
Version	Press [SPACE BAR] to select the RIP version. Choices are RIP-1 , RIP-2B or RIP-2M .	RIP-1
Incoming Protocol Filters	Enter the filter set(s) you wish to apply to the incoming traffic between this node and the Prestige.	
Outgoing Protocol Filters	Enter the filter set(s) you wish to apply to the outgoing traffic between this node and the Prestige.	
When you have completed this menu, press [ENTER] at the prompt "Press ENTER to Confirm..." to save your configuration, or press [ESC] at any time to cancel.		

28.5 Route IP Setup

The first step is to enable the IP routing in **Menu 1 — General Setup**.

To edit menu 1, type in 1 in the main menu and press [ENTER]. Set the **Route IP** field to **Yes** by pressing [SPACE BAR].

```

Menu 1 - General Setup

System Name= P653HWI
Location= location
Contact Person's Name=
Domain Name=
Edit Dynamic DNS= No

Route IP= Yes
Bridge= No

Press ENTER to Confirm or ESC to Cancel:
    
```

Figure 28-5 Menu 1 General Setup

28.6 Internet Access Configuration

Menu 4 allows you to enter the Internet Access information in one screen. Menu 4 is actually a simplified setup for one of the remote nodes that you can access in menu 11. Before you configure your Prestige for Internet access, you need to collect your Internet account information.

Use the *Internet Account Information* table in the *Compact Guide/Read Me First/Quick Start Guide* to record your. Note that if you are using PPPoA or PPPoE encapsulation, then the only ISP information you need is a login name and password. You only need to know the Ethernet Encapsulation Gateway IP address if you are using ENET ENCAP encapsulation.

From the main menu, type 4 to display **Menu 4 - Internet Access Setup**, as shown next.

```

Menu 4 - Internet Access Setup

ISP's Name= MyISP
Encapsulation= ENET ENCAP
Multiplexing= LLC-based
VPI #= 22
VCI #= 222
Service Name= N/A
My Login= N/A
My Password= N/A

NAT= Full Feature
  Address Mapping Set= 1
IP Address Assignment= Static
IP Address= 0.0.0.0
ENET ENCAP Gateway= 0.0.0.0

Press ENTER to Confirm or ESC to Cancel:

```

Figure 28-6 Menu 4 Internet Access Setup

The following table contains instructions on how to configure your Prestige for Internet access.

Table 28-2 Menu 4 Internet Access Setup

FIELD	DESCRIPTION	EXAMPLE
ISP's Name	Enter the name of your Internet Service Provider. This information is for identification purposes only.	MyISP
Encapsulation	Press [SPACE BAR] to select the method of encapsulation used by your ISP. Choices are PPPoE , PPPoA , RFC 1483 or ENET ENCAP .	ENET ENCAP

Table 28-2 Menu 4 Internet Access Setup

FIELD	DESCRIPTION	EXAMPLE
Multiplexing	Press [SPACE BAR] to select the method of multiplexing used by your ISP. Choices are VC-based or LLC-based .	LLC-based
VPI #	Enter the Virtual Path Identifier (VPI) assigned to you.	8
VCI #	Enter the Virtual Channel Identifier (VCI) assigned to you.	35
Service Name	When using PPPoE encapsulation, type the name of your PPPoE service here.	
My Login	Configure the My Login and My Password fields for PPPoA and PPPoE encapsulation only. Enter the login name that your ISP gives you. If you are using PPPoE encapsulation, then this field must be in the form user@domain where domain identifies your PPPoE service name.	N/A
My Password	Enter the password associated with the login name above.	N/A
Idle Timeout (PPPOE only)	This value specifies the number of idle seconds that elapse before the Prestige automatically disconnects the PPPoE session.	0
NAT	Press [SPACE BAR] to select None , SUA Only or Full Feature . Please see the <i>NAT Chapter</i> for more details on NAT.	SUA Only
Address Mapping Set	Type the numbers of mapping sets (1-8) to use with NAT. See the <i>NAT</i> chapter for details.	N/A
IP Address Assignment	Press [SPACE BAR] to select Static or Dynamic address assignment.	Dynamic
IP Address	Enter the IP address supplied by your ISP if applicable.	N/A
ENET ENCAP Gateway	Enter the gateway IP address supplied by your ISP when you are using ENET ENCAP encapsulation.	N/A
When you have completed this menu, press [ENTER] at the prompt "Press ENTER to confirm or ESC to cancel" to save your configuration or press [ESC] to cancel and go back to the previous screen.		

If all your settings are correct your Prestige should connect automatically to the Internet. If the connection fails, note the error message that you receive on the screen and take the appropriate troubleshooting steps.

Chapter 29

Remote Node Configuration

This chapter covers remote node configuration.

29.1 Remote Node Setup Overview

This section describes the protocol-independent parameters for a remote node. A remote node is required for placing calls to a remote gateway. A remote node represents both the remote gateway and the network behind it across a WAN connection. When you use menu 4 to set up Internet access, you are configuring one of the remote nodes.

You first choose a remote node in **Menu 11- Remote Node Setup**. You can then edit that node's profile in menu 11.1, as well as configure specific settings in three submenus: edit IP and bridge options in menu 11.3; edit ATM options in menu 11.6; and edit filter sets in menu 11.5.

29.2 Remote Node Setup

This section describes the protocol-independent parameters for a remote node.

29.2.1 Remote Node Profile

To configure a remote node, follow these steps:

- Step 1.** From the main menu, enter 11 to display **Menu 11 - Remote Node Setup**.
- Step 2.** When menu 11 appears, as shown in the following figure, type the number of the remote node that you want to configure.

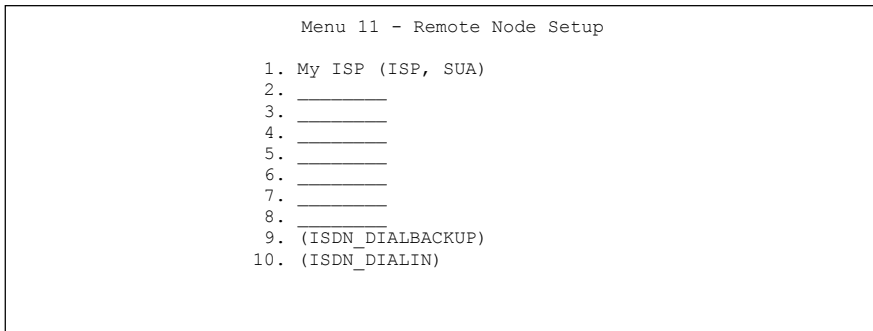

Figure 29-1 Menu 11 Remote Node Setup

29.2.2 Encapsulation and Multiplexing Scenarios

For Internet access you should use the encapsulation and multiplexing methods used by your ISP. Consult your telephone company for information on encapsulation and multiplexing methods for LAN-to-LAN applications, for example between a branch office and corporate headquarters. There must be prior agreement on encapsulation and multiplexing methods because they cannot be automatically determined. What method(s) you use also depends on how many VCs you have and how many different network protocols you need. The extra overhead that ENET ENCAP encapsulation entails makes it a poor choice in a LAN-to-LAN application. Here are some examples of more suitable combinations in such an application.

Scenario 1. One VC, Multiple Protocols

PPPoA (RFC-2364) encapsulation with **VC-based** multiplexing is the best combination because no extra protocol identifying headers are needed. The **PPP** protocol already contains this information.

Scenario 2. One VC, One Protocol (IP)

Selecting **RFC-1483** encapsulation with **VC-based** multiplexing requires the least amount of overhead (0 octets). However, if there is a potential need for multiple protocol support in the future, it may be safer to select **PPPoA** encapsulation instead of **RFC-1483**, so you do not need to reconfigure either computer later.

Scenario 3. Multiple VCs

If you have an equal number (or more) of VCs than the number of protocols, then select **RFC-1483** encapsulation and **VC-based** multiplexing.

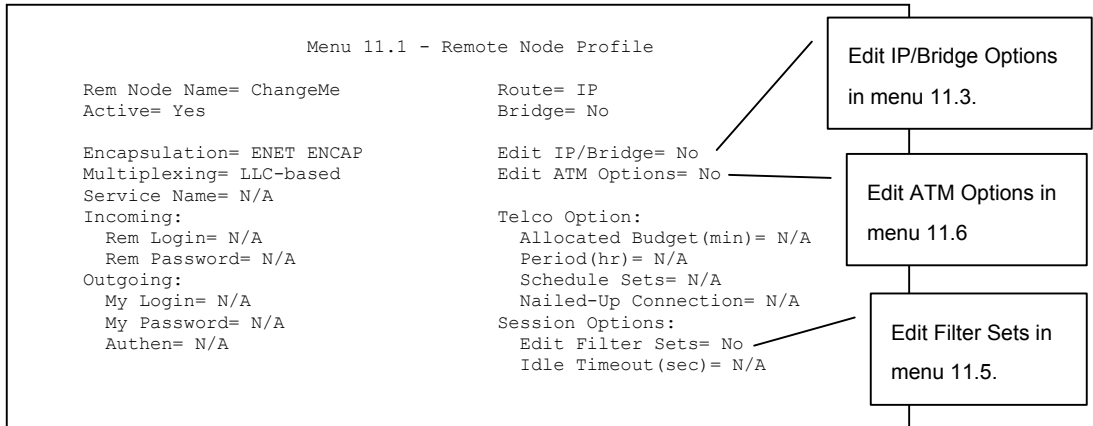

Figure 29-2 Menu 11.1 Remote Node Profile

In **Menu 11.1 – Remote Node Profile**, fill in the fields as described in the following table.

Table 29-1 Menu 11.1 Remote Node Profile

FIELD	DESCRIPTION	EXAMPLE
Rem Node Name	Type a unique, descriptive name of up to eight characters for this node.	ChangeMe
Active	Press [SPACE BAR] and then [ENTER] to select Yes to activate or No to deactivate this node. Inactive nodes are displayed with a minus sign “-“ in SMT menu 11.	Yes
Encapsulation	PPPoA refers to RFC-2364 (PPP Encapsulation over ATM Adaptation Layer 5). If RFC-1483 (Multiprotocol Encapsulation over ATM Adaptation Layer 5) or ENET ENCAP is selected, then the Rem Login , Rem Password , My Login , My Password and Authen fields are not applicable (N/A).	ENET ENCAP
Multiplexing	Press [SPACE BAR] and then [ENTER] to select the method of multiplexing that your ISP uses, either VC-based or LLC-based .	LLC-based
Service Name	When using PPPoE encapsulation, type the name of your PPPoE service here.	N/A
Incoming:		

Table 29-1 Menu 11.1 Remote Node Profile

FIELD	DESCRIPTION	EXAMPLE
Rem Login	Type the login name that this remote node will use to call your Prestige. The login name and the Rem Password will be used to authenticate this node.	
Rem Password	Type the password used when this remote node calls your Prestige.	
Outgoing:		
My Login	Type the login name assigned by your ISP when the Prestige calls this remote node.	
My Password	Type the password assigned by your ISP when the Prestige calls this remote node.	
Authen	This field sets the authentication protocol used for outgoing calls. Options for this field are: CHAP/PAP – Your Prestige will accept either CHAP or PAP when requested by this remote node. CHAP – accept CHAP (Challenge Handshake Authentication Protocol) only. PAP – accept PAP (Password Authentication Protocol) only.	
Route	This field determines the protocol used in routing. Options are IP and None .	IP
Bridge	When bridging is enabled, your Prestige will forward any packet that it does not route to this remote node; otherwise, the packets are discarded. Select Yes to enable and No to disable.	No
Edit IP/Bridge	Press [SPACE BAR] to select Yes and press [ENTER] to display Menu 11.3 – Remote Node Network Layer Options .	No
Edit ATM Options	Press [SPACE BAR] to select Yes and press [ENTER] to display Menu 11.6 – Remote Node ATM Layer Options .	No
Telco Option		
Allocated Budget (min)	This sets a ceiling for outgoing call time for this remote node. The default for this field is 0 meaning no budget control.	
Period (hr)	This field is the time period that the budget should be reset. For example, if we are allowed to call this remote node for a maximum of 10 minutes every hour, then the Allocated Budget is (10 minutes) and the Period (hr) is 1 (hour).	

Table 29-1 Menu 11.1 Remote Node Profile

FIELD	DESCRIPTION	EXAMPLE
Schedule Sets	This field is only applicable for PPPoE and PPPoA encapsulation. You can apply up to four schedule sets here. For more details please refer to the <i>Call Schedule Setup</i> chapter.	
Nailed up Connection	This field is only applicable for PPPoE and PPPoA encapsulation. This field specifies if you want to make the connection to this remote node a nailed-up connection. More details are given earlier in this section.	
Session Options		
Edit Filter Sets	Use [SPACE BAR] to choose Yes and press [ENTER] to open menu 11.5 to edit the filter sets. See the <i>Remote Node Filter</i> section for more details.	No (default)
Idle Timeout (sec)	Type the number of seconds (0-9999) that can elapse when the Prestige is idle (there is no traffic going to the remote node), before the Prestige automatically disconnects the remote node. 0 means that the session will not timeout.	
When you have completed this menu, press [ENTER] at the prompt "Press ENTER to confirm or ESC to cancel" to save your configuration or press [ESC] to cancel and go back to the previous screen.		

29.2.3 Outgoing Authentication Protocol

For obvious reasons, you should employ the strongest authentication protocol possible. However, some vendors' implementation includes specific authentication protocol in the user profile. It will disconnect if the negotiated protocol is different from that in the user profile, even when the negotiated protocol is stronger than specified. If the peer disconnects right after a successful authentication, make sure that you specify the correct authentication protocol when connecting to such an implementation.

29.3 Remote Node Network Layer Options

For the TCP/IP parameters, perform the following steps to edit **Menu 11.3 – Remote Node Network Layer Options** as shown next.

Step 1. In menu 11.1, make sure **IP** is among the protocols in the **Route** field.

Step 2. Move the cursor to the **Edit IP/Bridge** field, press [SPACE BAR] to select **Yes**, then press [ENTER] to display **Menu 11.3 – Remote Node Network Layer Options**.

```

Menu 11.3 - Remote Node Network Layer Options

IP Options:                               Bridge Options:
IP Address Assignment= Dynamic           Ethernet Addr Timeout (min)= N/A
Rem IP Addr: 0.0.0.0
Rem Subnet Mask= 0.0.0.0
My WAN Addr= 0.0.0.0
NAT= Full Feature
    Address Mapping Set= 2
Metric= 2
Private= No
RIP Direction= None
    Version= RIP-1
Multicast= None
IP Policies= 3,4,5,6

Press ENTER to Confirm or ESC to Cancel:
    
```

Figure 29-3 Menu 11.3 Remote Node Network Layer Options

The next table explains fields in **Menu 11.3 – Remote Node Network Layer Options**.

Table 29-2 Menu 11.3 Remote Node Network Layer Options

FIELD	DESCRIPTION	EXAMPLE
IP Address Assignment	Press [SPACE BAR] and then [ENTER] to select Dynamic if the remote node is using a dynamically assigned IP address or Static if it is using a static (fixed) IP address. You will only be able to configure this in the ISP node (also the one you configure in menu 4), all other nodes are set to Static .	Dynamic
Rem IP Addr	This is the IP address you entered in the previous menu.	
Rem Subnet Mask	Type the subnet mask assigned to the remote node.	
My WAN Addr	Some implementations, especially UNIX derivatives, require separate IP network numbers for the WAN and LAN links and each end to have a unique address within the WAN network number. In that case, type the IP address assigned to the WAN port of your Prestige. NOTE: Refers to local Prestige address, not the remote router address.	

Table 29-2 Menu 11.3 Remote Node Network Layer Options

FIELD	DESCRIPTION	EXAMPLE
NAT	<p>Press [SPACE BAR] and then [ENTER] to select Full Feature if you have multiple public WAN IP addresses for your Prestige.</p> <p>Select SUA Only if you have just one public WAN IP address for your Prestige. The SMT uses Address Mapping Set 255 (menu 15.1 - see section 32.3.1).</p> <p>Select None to disable NAT.</p>	SUA Only
Address Mapping Set	<p>When Full Feature is selected in the NAT field, configure address mapping sets in menu 15.1. Select one of the NAT server sets (2-10) in menu 15.2 (see the <i>NAT</i> chapter for details) and type that number here.</p> <p>When SUA Only is selected in the NAT field, the SMT uses NAT server set 1 in menu 15.2 (see the <i>NAT</i> chapter for details).</p>	2
Metric	<p>The metric represents the “cost” of transmission for routing purposes. IP routing uses hop count as the cost measurement, with a minimum of 1 for directly connected networks. Type a number that approximates the cost for this link. The number need not be precise, but it must be between 1 and 15. In practice, 2 or 3 is usually a good number.</p>	2
Private	<p>This determines if the Prestige will include the route to this remote node in its RIP broadcasts. If set to Yes, this route is kept private and not included in RIP broadcast. If No, the route to this remote node will be propagated to other hosts through RIP broadcasts.</p>	No
RIP Direction	<p>Press [SPACE BAR] and then [ENTER] to select the RIP Direction. Options are Both, In Only, Out Only or None.</p>	None
Version	<p>Press [SPACE BAR] and then [ENTER] to select the RIP version. Options are RIP-1, RIP-2B or RIP-2M.</p>	RIP-1
Multicast	<p>IGMP-v1 sets IGMP to version 1, IGMP-v2 sets IGMP to version 2 and None disables IGMP.</p>	None
IP Policies	<p>You can apply up to four IP Policy sets (from 12) by typing in their numbers separated by commas. Configure the filter sets in menu 25 first (see the <i>IP Policy Routing</i> chapter) and then apply them here.</p>	3, 4, 5, 6
<p>When you have completed this menu, press [ENTER] at the prompt “Press ENTER to confirm or ESC to cancel” to save your configuration or press [ESC] to cancel and go back to the previous screen.</p>		

29.3.1 My WAN Addr Sample IP Addresses

The following figure uses sample IP addresses to help you understand the field of **My Wan Addr** in menu 11.3. Refer to the previous *LAN and WAN IP Addresses* figure in the web configurator chapter on LAN setup for a brief review of what a WAN IP is. **My WAN Addr** indicates the local Prestige WAN IP (172.16.0.1 in the following figure) while **Rem IP Addr** indicates the peer WAN IP (172.16.0.2 in the following figure).

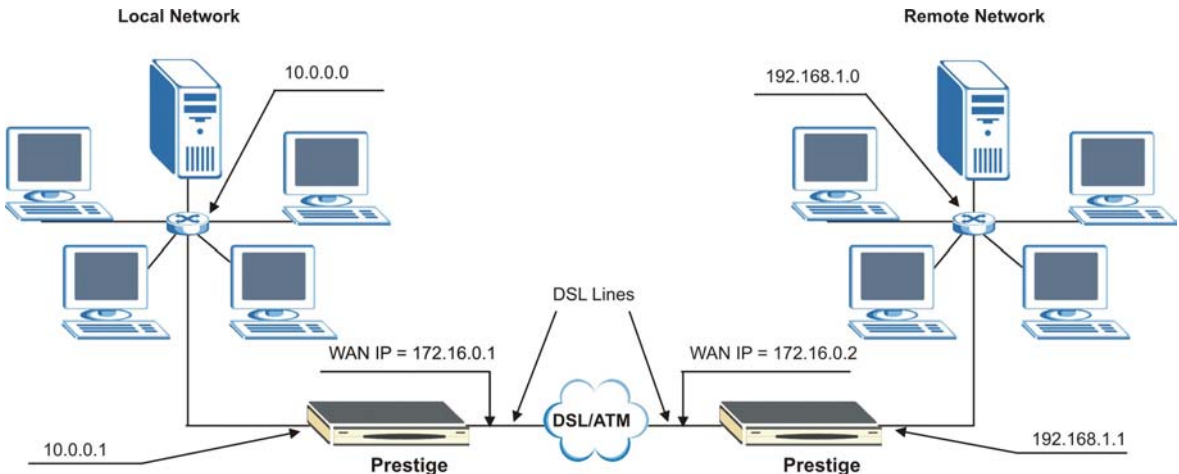

Figure 29-4 Sample IP Addresses for a TCP/IP LAN-to-LAN Connection

29.4 Remote Node Filter

Move the cursor to the **Edit Filter Sets** field in menu 11.1, then press [SPACE BAR] to select **Yes**. Press [ENTER] to display **Menu 11.5 – Remote Node Filter**.

Use **Menu 11.5 – Remote Node Filter** to specify the filter set(s) to apply to the incoming and outgoing traffic between this remote node and the Prestige and also to prevent certain packets from triggering calls. You can specify up to 4 filter sets separated by comma, for example, 1, 5, 9, 12, in each filter field.

Note that spaces are accepted in this field. The Prestige has a prepackaged filter set, NetBIOS_WAN, that blocks NetBIOS packets. Include this in the call filter sets if you want to prevent NetBIOS packets from triggering calls to a remote node.

```

Menu 11.5 - Remote Node Filter

Input Filter Sets:
  protocol filters= 11, 12
  device filters=
Output Filter Sets:
  protocol filters=
  device filters=

Enter here to CONFIRM or ESC to CANCEL:

```

Figure 29-5 Menu 11.5 Remote Node Filter (RFC 1483 or ENET Encapsulation)

```

Menu 11.5 - Remote Node Filter

Input Filter Sets:
  protocol filters= 11, 12
  device filters=
Output Filter Sets:
  protocol filters=
  device filters=
Call Filter Sets:
  Protocol filters=
  Device filters=

Enter here to CONFIRM or ESC to CANCEL:

```

Figure 29-6 Menu 11.5 Remote Node Filter (PPPoA or PPPoE Encapsulation)

29.5 Editing ATM Layer Options

Follow the steps shown next to edit **Menu 11.6 – Remote Node ATM Layer Options**.

In menu 11.1, move the cursor to the **Edit ATM Options** field and then press [SPACE BAR] to select **Yes**. Press [ENTER] to display **Menu 11.6 – Remote Node ATM Layer Options**.

There are two versions of menu 11.6 for the Prestige, depending on whether you chose **VC-based/LLC-based** multiplexing and **PPP** encapsulation in menu 11.1.

29.5.1 VC-based Multiplexing (non-PPP Encapsulation)

For **VC-based** multiplexing, by prior agreement, a protocol is assigned a specific virtual circuit, for example, VC1 will carry IP. Separate VPI and VCI numbers must be specified for each protocol.

```

Menu 11.6 - Remote Node ATM Layer Options
VPI/VCI (VC-Multiplexing)

VC Options for IP:
VPI #= 8
VCI #= 35
ATM QoS Type= UBR
Peak Cell Rate (PCR)= 0
Sustain Cell Rate (SCR)= 0
Maximum Burst Size (MBS)= 0

VC Options for Bridge:
VPI #= 1
VCI #= 36
ATM QoS Type= N/A
Peak Cell Rate (PCR)= N/A
Sustain Cell Rate (SCR)= N/A
Maximum Burst Size (MBR)= N/A

Press ENTER to Confirm or ESC to Cancel:
    
```

Figure 29-7 Menu 11.6 for VC-based Multiplexing

29.5.2 LLC-based Multiplexing or PPP Encapsulation

For **LLC-based** multiplexing or **PPP** encapsulation, one VC carries multiple protocols with protocol identifying information being contained in each packet header.

```

Menu 11.6 - Remote Node ATM Layer Options
VPI/VCI (LLC-Multiplexing or PPP-Encapsulation)

VPI #= 8
VCI #= 35
ATM QoS Type= UBR
Peak Cell Rate (PCR)= 0
Sustain Cell Rate (SCR)= 0
Maximum Burst Size (MBS)= 0

ENTER here to CONFIRM or ESC to CANCEL:
    
```

Figure 29-8 Menu 11.6 for LLC-based Multiplexing or PPP Encapsulation

In this case, only one set of VPI and VCI numbers need be specified for all protocols. The valid range for the VPI is 0 to 255 and for the VCI is 32 to 65535 (1 to 31 is reserved for local management of ATM traffic).

29.5.3 Remote Node Profile(ISDN Dial Backup)

In menu 11, enter 9 to configure the built-in profile - **ISDN_DIALBACKUP**.

```

Menu 11.1 - Remote Node Profile

Rem Node Name= ?           Edit PPP Options= No
Active= Yes                Rem IP Addr= ?
Call Direction= Both       Edit IP= No

Incoming:                  Telco Option:
  Rem Login= ?
  Rem Password= ?          Allocated Budget(min)=
  Rem CLID=                Period(hr)=
  Call Back= No            Schedules=
Outgoing:                  Carrier Access Code=
  My Login=
  My Password= *****
  Authen= CHAP/PAP         Session Options:
  Pri Phone #= ?           Edit Filter Sets= No
  Sec Phone #=             Idle Timeout(sec)= 300

Press ENTER to Confirm or ESC to Cancel:

```

Figure 29-9 Menu 11.1 Remote Node Profile(ISDN Dial Backup)

29.5.4 Remote Node Profile(ISDN Dial In)

In menu 11, enter 10 to configure the built-in profile - **ISDN_DIALIN**.

```

Menu 11.1 - Remote Node Profile

Rem Node Name= ?           Edit PPP Options= No
Active= Yes                Rem IP Addr= ?
Call Direction= Both       Edit IP= No

Incoming:                  Telco Option:
  Rem Login= ?
  Rem Password= ?          Allocated Budget(min)=
  Rem CLID=                Period(hr)=
  Call Back= No            Schedules=
Outgoing:                  Carrier Access Code=
  My Login=
  My Password= *****
  Authen= CHAP/PAP         Session Options:
  Pri Phone #= ?           Edit Filter Sets= No
  Sec Phone #=             Idle Timeout(sec)= 300

Press ENTER to Confirm or ESC to Cancel:

```

Figure 29-10 Menu 11.1 Remote Node Profile(ISDN Dial In)

Chapter 30

Static Route Setup

This chapter shows how to setup IP static routes.

30.1 IP Static Route Overview

Static routes tell the Prestige routing information that it cannot learn automatically through other means. This can arise in cases where RIP is disabled on the LAN or a remote network is beyond the one that is directly connected to a remote node.

Each remote node specifies only the network to which the gateway is directly connected and the Prestige has no knowledge of the networks beyond. For instance, the Prestige knows about network N2 in the following figure through remote node Router 1. However, the Prestige is unable to route a packet to network N3 because it does not know that there is a route through remote node Router 1 (via Router 2). The static routes allow you to tell the Prestige about the networks beyond the remote nodes.

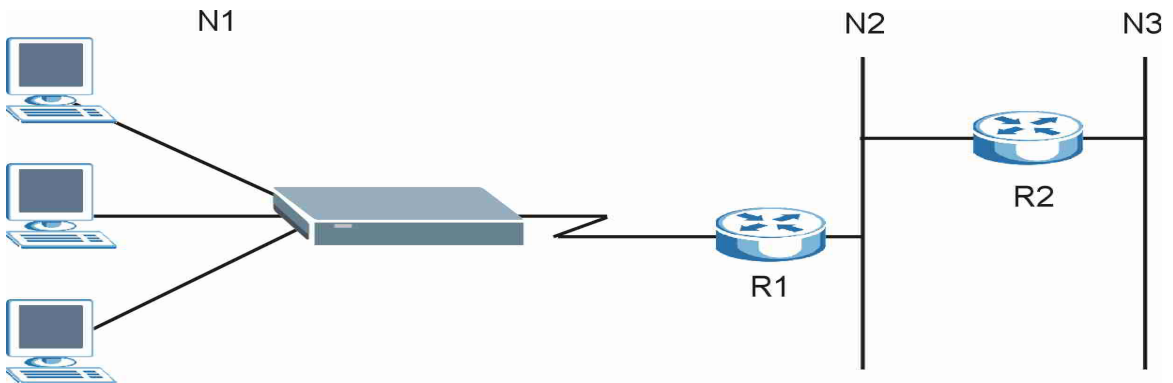

Figure 30-1 Sample Static Routing Topology

30.2 Configuration

Step 1. To configure an IP static route, use **Menu 12 – Static Route Setup** (shown next).

```
Menu 12 - Static Route Setup

    1. IP Static Route
    3. Bridge Static Route

Please enter selection:
```

Figure 30-2 Menu 12 Static Route Setup

Step 2. From menu 12, select 1 to open **Menu 12.1 — IP Static Route Setup** (shown next).

```
Menu 12.1 - IP Static Route Setup

1. _____
2. _____
3. _____
4. _____
5. _____
6. _____
7. _____
8. _____
9. _____
10. _____
11. _____
12. _____
13. _____
14. _____
15. _____
16. _____

Enter selection number:
```

Figure 30-3 Menu 12.1 IP Static Route Setup

Step 3. Now, type the route number of a static route you want to configure.

```

Menu 12.1.1 - Edit IP Static Route

Route #: 1
Route Name= ?
Active= No
Destination IP Address= ?
IP Subnet Mask= ?
Gateway IP Address= ?
Metric= 2
Private= No

Press ENTER to Confirm or ESC to Cancel:
    
```

Figure 30-4 Menu12.1.1 Edit IP Static Route

The following table describes the fields for **Menu 12.1.1 – Edit IP Static Route Setup**.

Table 30-1 Menu12.1.1 Edit IP Static Route

FIELD	DESCRIPTION
Route #	This is the index number of the static route that you chose in menu 12.1.
Route Name	Type a descriptive name for this route. This is for identification purpose only.
Active	This field allows you to activate/deactivate this static route.
Destination IP Address	This parameter specifies the IP network address of the final destination. Routing is always based on network number. If you need to specify a route to a single host, use a subnet mask of 255.255.255.255 in the subnet mask field to force the network number to be identical to the host ID.
IP Subnet Mask	Type the subnet mask for this destination. Follow the discussion on <i>IP Subnet Mask</i> in this manual.
Gateway IP Address	Type the IP address of the gateway. The gateway is an immediate neighbor of your Prestige that will forward the packet to the destination. On the LAN, the gateway must be a router on the same segment as your Prestige; over WAN, the gateway must be the IP address of one of the remote nodes.
Metric	Metric represents the “cost” of transmission for routing purposes. IP routing uses hop count as the measurement of cost, with a minimum of 1 for directly connected networks. Type a number that approximates the cost for this link. The number need not be precise, but it must be between 1 and 15. In practice, 2 or 3 is usually a good number.

Table 30-1 Menu12.1.1 Edit IP Static Route

FIELD	DESCRIPTION
Private	This parameter determines if the Prestige will include the route to this remote node in its RIP broadcasts. If set to Yes , this route is kept private and is not included in RIP broadcasts. If No , the route to this remote node will be propagated to other hosts through RIP broadcasts.
When you have completed this menu, press [ENTER] at the prompt "Press ENTER to confirm or ESC to cancel" to save your configuration or press [ESC] to cancel and go back to the previous screen.	

Chapter 31

Bridging Setup

This chapter shows you how to configure the bridging parameters of your Prestige.

31.1 Bridging in General

Bridging bases the forwarding decision on the MAC (Media Access Control), or hardware address, while routing does it on the network layer (IP) address. Bridging allows the Prestige to transport packets of network layer protocols that it does not route, for example, SNA, from one network to another. The caveat is that, compared to routing, bridging generates more traffic for the same network layer protocol, and it also demands more CPU cycles and memory.

For efficiency reasons, do *not* turn on bridging unless you need to support protocols other than IP on your network. For IP, enable the routing if you need it; do not bridge what the Prestige can route.

31.2 Bridge Ethernet Setup

Basically, all non-local packets are bridged to the WAN. Your Prestige does not support IPX.

31.2.1 Remote Node Bridging Setup

Follow the procedure in another section to configure the protocol-independent parameters in **Menu 11.1 – Remote Node Profile**. For bridging-related parameters, you need to configure **Menu 11.3 – Remote Node Network Layer Options**.

To setup **Menu 11.3 – Remote Node Network Layer Options** shown in the next figure, follow these steps:

Step 1. In menu 11.1, make sure the **Bridge** field is set to **Yes**.

```
Menu 11.1 - Remote Node Profile

Rem Node Name= ?           Route= IP
Active= Yes                Bridge= Yes

Encapsulation= ENET ENCAP Edit IP/Bridge= No
Multiplexing= VC-based    Edit ATM Options= No
Service Name= N/A

Incoming:                  Telco Option:
  Rem Login= N/A           Allocated Budget(min)= N/A
  Rem Password= N/A       Period(hr)= N/A
                          Schedule Sets= N/A
Outgoing:                  Nailed-Up Connection= N/A
  My Login= N/A           Session Options:
  My Password= N/A       Edit Filter Sets= No
  Authen= N/A            Idle Timeout(sec)= N/A

Press ENTER to Confirm or ESC to Cancel:
```

Figure 31-1 Menu 11.1 Remote Node Profile

Step 2. Move the cursor to the **Edit IP/Bridge** field, then press [SPACE BAR] to set the value to **Yes** and press [ENTER] to edit **Menu 11.3 – Remote Node Network Layer Options**.

```
Menu 11.3 - Remote Node Network Layer Options

IP Options:                Bridge Options:
IP Address Assignment= Static Ethernet Addr Timeout (min)= 0
Rem IP Addr: 0.0.0.0
  Rem Subnet Mask= 0.0.0.0
  My WAN Addr= 0.0.0.0
  NAT= Full Feature
    Address Mapping Set=2
  Metric= 2
  Private= No
  RIP Direction= Both
    Version= RIP-2B
  Multicast= IGMP-v2
  IP Policies=

Press ENTER to Confirm or ESC to Cancel:
```

Figure 31-2 Menu 11.3 Remote Node Network Layer Options

Table 31-1 Remote Node Network Layer Options : Bridge Fields

FIELD	DESCRIPTION
Bridge (menu 11.1)	Make sure this field is set to Yes .
Edit IP/Bridge (menu 11.1)	Press [SPACE BAR] to select Yes and press [ENTER] to display menu 11.3.
Ethernet Addr Timeout (min.) (menu 11.3)	Type the time (in minutes) for the Prestige to retain the Ethernet Address information in its internal tables while the line is down. If this information is retained, your Prestige will not have to recompile the tables when the line comes back up.
When you have completed this menu, press [ENTER] at the prompt "Press ENTER to confirm or ESC to cancel" to save your configuration or press [ESC] to cancel and go back to the previous screen.	

31.2.2 Bridge Static Route Setup

Similar to network layer static routes, a bridging static route tells the Prestige the route to a node before a connection is established. You configure bridge static routes in menu 12.3.1 (go to menu 12, choose option 3, then choose a static route to edit) as shown next.

```

Menu 12.3.1 - Edit Bridge Static Route

Route #: 1
Route Name=
Active= No
Ether Address= ?
IP Address=
Gateway Node= 1

Press ENTER to Confirm or ESC to Cancel:

```

Figure 31-3 Menu 12.3.1 Edit Bridge Static Route

The following table describes the **Edit Bridge Static Route** menu.

Table 31-2 Menu 12.3.1 Edit Bridge Static Route

FIELD	DESCRIPTION
Route #	This is the route index number you typed in Menu 12.3 – Bridge Static Route Setup .
Route Name	Type a name for the bridge static route for identification purposes.

FIELD	DESCRIPTION
Active	Indicates whether the static route is active (Yes) or not (No).
Ether Address	Type the MAC address of the destination computer that you want to bridge the packets to.
IP Address	If available, type the IP address of the destination computer that you want to bridge the packets to.
Gateway Node	Press [SPACE BAR] and then [ENTER] to select the number of the remote node (one to eight) that is the gateway of this static route.
When you have completed this menu, press [ENTER] at the prompt "Press ENTER to confirm or ESC to cancel" to save your configuration or press [ESC] to cancel and go back to the previous screen.	

Chapter 32

Network Address Translation (NAT)

This chapter discusses how to configure NAT on the Prestige.

32.1 Using NAT

You must create a firewall rule in addition to setting up SUA/NAT, to allow traffic from the WAN to be forwarded through the Prestige.

32.1.1 SUA (Single User Account) Versus NAT

SUA (Single User Account) is a ZyNOS implementation of a subset of NAT that supports two types of mapping, **Many-to-One** and **Server**. See *section 32.3.1* for a detailed description of the NAT set for SUA. The Prestige also supports **Full Feature** NAT to map multiple global IP addresses to multiple private LAN IP addresses of clients or servers using mapping types as outlined in the *Web Configurator User's Guide*.

- 1. Choose SUA Only if you have just one public WAN IP address for your Prestige.**
- 2. Choose Full Feature if you have multiple public WAN IP addresses for your Prestige.**

32.2 Applying NAT

You apply NAT via menus 4 or 11.3 as displayed next. The next figure shows you how to apply NAT for Internet access in menu 4. Enter 4 from the main menu to go to **Menu 4 - Internet Access Setup**.

```
Menu 4 - Internet Access Setup

ISP's Name= MyISP
Encapsulation= RFC 1483
Multiplexing= LLC-based
VPI #= 8
VCI #= 35
Service Name= N/A
My Login= N/A
My Password= N/A

NAT= SUA Only
Address Mapping Set= N/A
IP Address Assignment= Static
IP Address= 0.0.0.0
ENET ENCAP Gateway= N/A

Press ENTER to Confirm or ESC to Cancel:
```

Figure 32-1 Menu 4 Applying NAT for Internet Access

The following figure shows how you apply NAT to the remote node in menu 11.1.

- Step 1.** Enter 11 from the main menu.
- Step 2.** When menu 11 appears, as shown in the following figure, type the number of the remote node that you want to configure.
- Step 3.** Move the cursor to the **Edit IP/Bridge** field, press [SPACE BAR] to select **Yes** and then press [ENTER] to bring up **Menu 11.3 - Remote Node Network Layer Options**.

```

Menu 11.3 - Remote Node Network Layer Options

IP Options:                               Bridge Options:
IP Address Assignment = Dynamic           Ethernet Addr Timeout(min)= N/A
Rem IP Addr = 0.0.0.0
Rem Subnet Mask= 0.0.0.0
My WAN Addr= N/A
NAT= SUA Only
    Address Mapping Set= N/A
Metric= 2
Private= No
RIP Direction= None
    Version= RIP-1
Multicast= None
IP Policies=

Enter here to CONFIRM or ESC to CANCEL:
    
```

Figure 32-2 Menu 11.3 Applying NAT to the Remote Node

The following table describes the options for Network Address Translation.

Table 32-1 Applying NAT in Menus 4 & 11.3

FIELD	DESCRIPTION	EXAMPLE
NAT	Press [SPACE BAR] and then [ENTER] to select Full Feature if you have multiple public WAN IP addresses for your Prestige. The SMT uses the address mapping set that you configure and enter in the Address Mapping Set field (menu 15.1 - see section 32.3.1).	Full Feature
	Select None to disable NAT.	None
	When you select SUA Only , the SMT uses Address Mapping Set 255 (menu 15.1 - see section 32.3.1). Choose SUA Only if you have just one public WAN IP address for your Prestige.	SUA Only

32.3 NAT Setup

Use the address mapping sets menus and submenus to create the mapping table used to assign global addresses to computers on the LAN and the DMZ. You can see two NAT address mapping sets in menu 15.1. You can only configure **Set 1**. **Set 255** is used for SUA. When you select **Full Feature** in menu 4 or 11.3, the SMT will use **Set 1**. When you select **SUA Only**, the SMT will use the pre-configured **Set 255** (read only).

The server set is a list of LAN and DMZ servers mapped to external ports. To use this set, a server rule must be set up inside the NAT address mapping set. Please see the section on port forwarding in the chapter

on NAT web configurator screens for further information on these menus. To configure NAT, enter 15 from the main menu to bring up the following screen.

```
Menu 15 - NAT Setup

1.  Address Mapping Sets
2.  NAT Server Sets

Enter Menu Selection Number:
```

Figure 32-3 Menu 15 NAT Setup

32.3.1 Address Mapping Sets

Enter 1 to bring up **Menu 15.1 — Address Mapping Sets**.

```
Menu 15.1 - Address Mapping Sets

1.  ACL Default Set
2.
3.
4.
5.
6.
7.
8.
255. SUA (read only)

Enter Menu Selection Number:

Enter Menu Selection Number:
```

Figure 32-4 Menu 15.1 Address Mapping Sets

SUA Address Mapping Set

Enter 255 to display the next screen (see also *section 32.1.1*). The fields in this menu cannot be changed.

```

Menu 15.1.255 - Address Mapping Rules

Set Name=

Idx  Local Start IP  Local End IP  Global Start IP  Global End IP  Type
-----
1.   0.0.0.0         255.255.255.255  0.0.0.0         0.0.0.0       M-1
2.                                     0.0.0.0         Server
3.
4.
5.
6.
7.
8.
9.
10.

Press ENTER to Confirm or ESC to Cancel:

```

Figure 32-5 Menu 15.1.255 SUA Address Mapping Rules

The following table explains the fields in this menu.

Menu 15.1.255 is read-only.

Table 32-2 SUA Address Mapping Rules

FIELD	DESCRIPTION	EXAMPLE
Set Name	This is the name of the set you selected in menu 15.1 or enter the name of a new set you want to create.	SUA
Idx	This is the index or rule number.	1
Local Start IP	Local Start IP is the starting local IP address (ILA).	0.0.0.0
Local End IP	Local End IP is the ending local IP address (ILA). If the rule is for all local IPs, then the Start IP is 0.0.0.0 and the End IP is 255.255.255.255.	255.255.255.255
Global Start IP	This is the starting global IP address (IGA). If you have a dynamic IP, enter 0.0.0.0 as the Global Start IP .	0.0.0.0
Global End IP	This is the ending global IP address (IGA).	
Type	These are the mapping types. Server allows us to specify multiple servers of different types behind NAT to this machine. See later for some examples.	Server

When you have completed this menu, press [ENTER] at the prompt "Press ENTER to confirm or ESC to cancel" to save your configuration or press [ESC] to cancel and go back to the previous screen.

User-Defined Address Mapping Sets

Now let's look at option 1 in menu 15.1. Enter 1 to bring up this menu. We'll just look at the differences from the previous menu. Note the extra **Action** and **Select Rule** fields mean you can configure rules in this screen. Note also that the [?] in the **Set Name** field means that this is a required field and you must enter a name for the set.

```

Menu 15.1.1 - Address Mapping Rules

Set Name= NAT_SET

Idx  Local Start IP  Local End IP  Global Start IP  Global End IP  Type
---  -
1.
2.
3.
4.
5.
6.
7.
8.
9.
10.

Action= Edit      Select Rule=

Press ENTER to Confirm or ESC to Cancel:
    
```

Figure 32-6 Menu 15.1.1 First Set

If the Set Name field is left blank, the entire set will be deleted.

The Type, Local and Global Start/End IPs are configured in menu 15.1.1.1 (described later) and the values are displayed here.

Ordering Your Rules

Ordering your rules is important because the Prestige applies the rules in the order that you specify. When a rule matches the current packet, the Prestige takes the corresponding action and the remaining rules are ignored. If there are any empty rules before your new configured rule, your configured rule will be pushed up by that number of empty rules. For example, if you have already configured rules 1 to 6 in your current set and now you configure rule number 9. In the set summary screen, the new rule will be rule 7, not 9.

Now if you delete rule 4, rules 5 to 7 will be pushed up by 1 rule, so as old rule 5 becomes rule 4, old rule 6 becomes rule 5 and old rule 7 becomes rule 6.

FIELD	DESCRIPTION	EXAMPLE
Set Name	Enter a name for this set of rules. This is a required field. If this field is left blank, the entire set will be deleted.	NAT_SET
Action	The default is Edit . Edit means you want to edit a selected rule (see following field). Insert Before means to insert a rule before the rule selected. The rules after the selected rule will then be moved down by one rule. Delete means to delete the selected rule and then all the rules after the selected one will be advanced one rule. None disables the Select Rule item.	Edit
Select Rule	When you choose Edit , Insert Before or Delete in the previous field the cursor jumps to this field to allow you to select the rule to apply the action in question.	1

Table 32-3 Menu 15.1.1 First Set

You must press [ENTER] at the bottom of the screen to save the whole set. You must do this again if you make any changes to the set – including deleting a rule. No changes to the set take place until this action is taken.

Selecting **Edit** in the **Action** field and then selecting a rule brings up the following menu, **Menu 15.1.1.1 - Address Mapping Rule** in which you can edit an individual rule and configure the **Type**, **Local** and **Global Start/End IPs**.

An End IP address must be numerically greater than its corresponding IP Start address.

Figure 32-7 Menu 15.1.1.1 Editing/Configuring an Individual Rule in a Set

```

Menu 15.1.1.1 Address Mapping Rule

Type= One-to-One

Local IP:
  Start=
  End = N/A

Global IP:
  Start=
  End = N/A

Server Mapping Set= N/A

Press ENTER to Confirm or ESC to Cancel:

Press Space Bar to Toggle.
    
```

The following table explains the fields in this menu.

Table 32-4 Menu 15.1.1.1 Editing/Configuring an Individual Rule in a Set

FIELD	DESCRIPTION	EXAMPLE
Type	Press [SPACE BAR] and then [ENTER] to select from a total of five types. These are the mapping types discussed in the chapter on NAT web configurator screens. Server allows you to specify multiple servers of different types behind NAT to this computer. See <i>section 32.5.3</i> for an example.	One-to-One
Local IP	Only local IP fields are N/A for server; Global IP fields MUST be set for Server .	
Start	This is the starting local IP address (ILA).	0.0.0.0
End	This is the ending local IP address (ILA). If the rule is for all local IPs, then put the Start IP as 0.0.0.0 and the End IP as 255.255.255.255. This field is N/A for One-to-One and Server types.	N/A
Global IP		
Start	This is the starting inside global IP address (IGA). If you have a dynamic IP, enter 0.0.0.0 as the Global IP Start . Note that Global IP Start can be set to 0.0.0.0 only if the types are Many-to-One or Server .	0.0.0.0
End	This is the ending inside global IP address (IGA). This field is N/A for One-to-One , Many-to-One and Server types.	N/A
Server Mapping Set	Only available when Type is set to Server . Type a number from 1 to 10 to choose a server set from menu 15.2.	

Table 32-4 Menu 15.1.1.1 Editing/Configuring an Individual Rule in a Set

When you have completed this menu, press [ENTER] at the prompt "Press ENTER to confirm or ESC to cancel" to save your configuration or press [ESC] to cancel and go back to the previous screen.

32.4 Configuring a Server behind NAT

Follow these steps to configure a server behind NAT:

- Step 1.** Enter 15 in the main menu to go to **Menu 15 - NAT Setup**.
- Step 2.** Enter 2 to display **Menu 15.2 - NAT Server Sets** as shown next.

```
Menu 15.2 - NAT Server Sets

1. Server Set 1 (Used for SUA Only)
2. Server Set 2
3. Server Set 3
4. Server Set 4
5. Server Set 5
6. Server Set 6
7. Server Set 7
8. Server Set 8
9. Server Set 9
10. Server Set 10

Enter Set Number to Edit:
```

Figure 32-8 Menu 15.2 NAT Server Setup

- Step 3.** Enter 1 to go to **Menu 15.2.1 NAT Server Setup** as follows.

Menu 15.2.1 - NAT Server Setup			
Rule	Start Port No.	End Port No.	IP Address
1.	Default	Default	0.0.0.0
2.	21	25	192.168.1.33
3.	0	0	0.0.0.0
4.	0	0	0.0.0.0
5.	0	0	0.0.0.0
6.	0	0	0.0.0.0
7.	0	0	0.0.0.0
8.	0	0	0.0.0.0
9.	0	0	0.0.0.0
10.	0	0	0.0.0.0
11.	0	0	0.0.0.0
12.	0	0	0.0.0.0

Press ENTER to Confirm or ESC to Cancel:

Figure 32-9 Menu 15.2.1 NAT Server Setup

- Step 4.** Enter a port number in an unused **Start Port No** field. To forward only one port, enter it again in the **End Port No** field. To specify a range of ports, enter the last port to be forwarded in the **End Port No** field.
- Step 5.** Enter the inside IP address of the server in the **IP Address** field. In the following figure, you have a computer acting as an FTP, Telnet and SMTP server (ports 21, 23 and 25) at 192.168.1.33.
- Step 6.** Press [ENTER] at the “Press ENTER to confirm ...” prompt to save your configuration after you define all the servers or press [ESC] at any time to cancel.

You assign the private network IP addresses. The NAT network appears as a single host on the Internet.

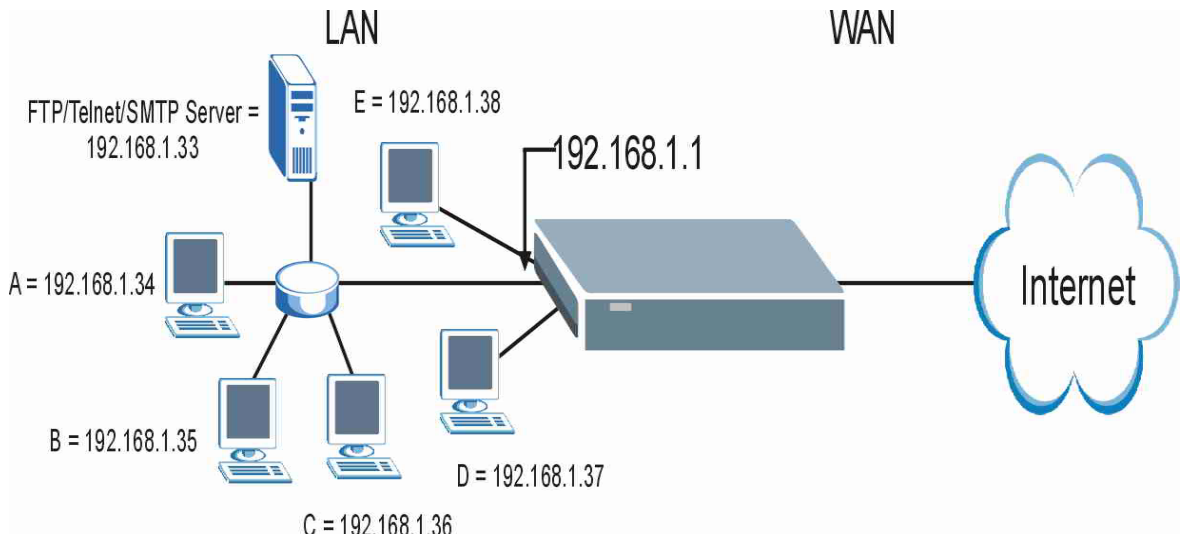

Figure 32-10 Multiple Servers Behind NAT Example

32.5 General NAT Examples

The following are some examples of NAT configuration.

32.5.1 Example 1: Internet Access Only

In the following Internet access example, you only need one rule where your ILAs (Inside Local addresses) all map to one dynamic IGA (Inside Global Address) assigned by your ISP.

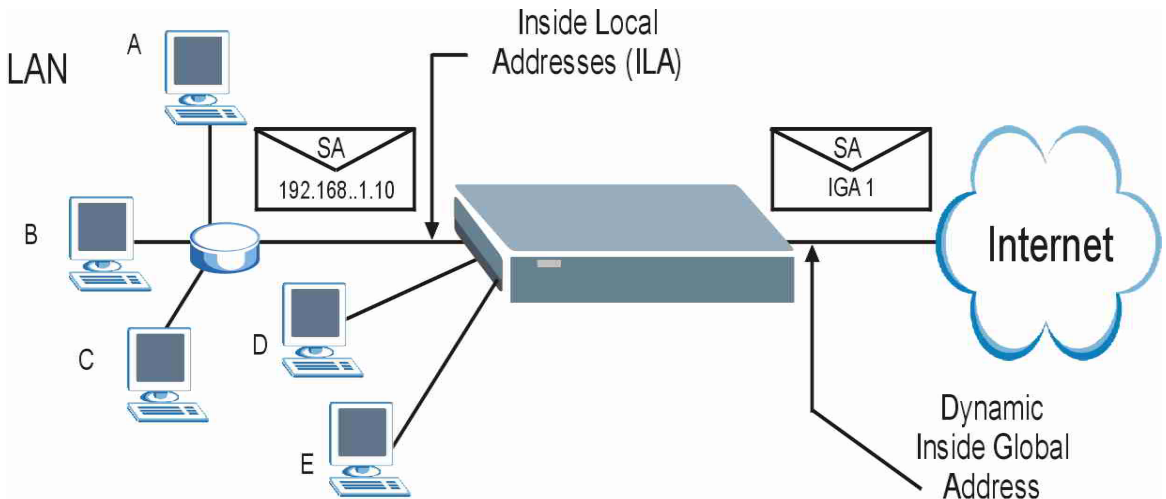

Figure 32-11 NAT Example 1

```

Menu 4 - Internet Access Setup

ISP's Name= MyISP
Encapsulation= RFC 1483
Multiplexing= LLC-based
VPI #= 8
VCI #= 35
Service Name= N/A
My Login= N/A
My Password= N/A

NAT= SUA Only
  Address Mapping Set= N/A
  IP Address Assignment= Static
  IP Address= 0.0.0.0
  ENET ENCAP Gateway= N/A

Press ENTER to Confirm or ESC to Cancel:
    
```

Figure 32-12 Menu 4 Internet Access & NAT Example

From menu 4, choose the **SUA Only** option from the **Network Address Translation** field. This is the Many-to-One mapping discussed in *section 32.5*. The **SUA Only** read-only option from the **Network Address Translation** field in menus 4 and 11.3 is specifically pre-configured to handle this case.

32.5.2 Example 2: Internet Access with an Inside Server

The dynamic Inside Global Address is assigned by the ISP.

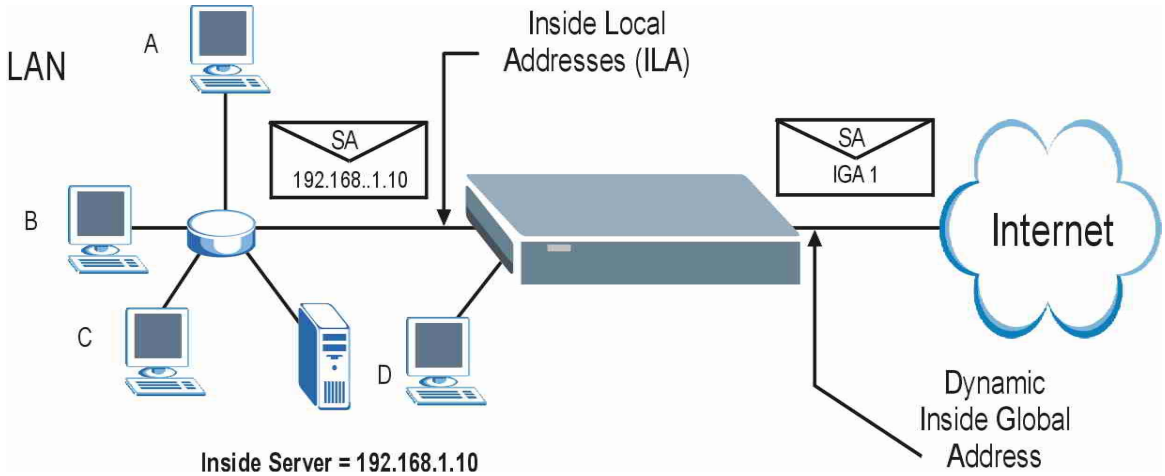

Figure 32-13 NAT Example 2

In this case, you do exactly as above (use the convenient pre-configured **SUA Only** set) and also go to menu 15.2 to specify the Inside Server behind the NAT as shown in the next figure.

```

Menu 15.2.1 - NAT Server Setup (Used for SUA Only)

Rule   Start Port No.  End Port No.  IP Address
-----
  1.   Default      Default      192.168.1.10
  2.     0              0              0.0.0.0
  3.     0              0              0.0.0.0
  4.     0              0              0.0.0.0
  5.     0              0              0.0.0.0
  6.     0              0              0.0.0.0
  7.     0              0              0.0.0.0
  8.     0              0              0.0.0.0
  9.     0              0              0.0.0.0
 10.    0              0              0.0.0.0
 11.    0              0              0.0.0.0
 12.    0              0              0.0.0.0

Press ENTER to Confirm or ESC to Cancel:
    
```

Figure 32-14 Menu 15.2.1 Specifying an Inside Server

32.5.3 Example 3: Multiple Public IP Addresses With Inside Servers

In this example, there are 3 IGAs from our ISP. There are many departments but two have their own FTP server. All departments share the same router. The example will reserve one IGA for each department with an FTP server and all departments use the other IGA. Map the FTP servers to the first two IGAs and the other LAN traffic to the remaining IGA. Map the third IGA to an inside web server and mail server. Four rules need to be configured, two bi-directional and two unidirectional as follows.

- Rule 1.** Map the first IGA to the first inside FTP server for FTP traffic in both directions (**1 : 1** mapping, giving both local and global IP addresses).
- Rule 2.** Map the second IGA to our second inside FTP server for FTP traffic in both directions (**1 : 1** mapping, giving both local and global IP addresses).
- Rule 3.** Map the other outgoing LAN traffic to IGA3 (**Many : 1** mapping).
- Rule 4.** You also map your third IGA to the web server and mail server on the LAN. Type **Server** allows you to specify multiple servers, of different types, to other computers behind NAT on the LAN.

The example situation looks somewhat like this:

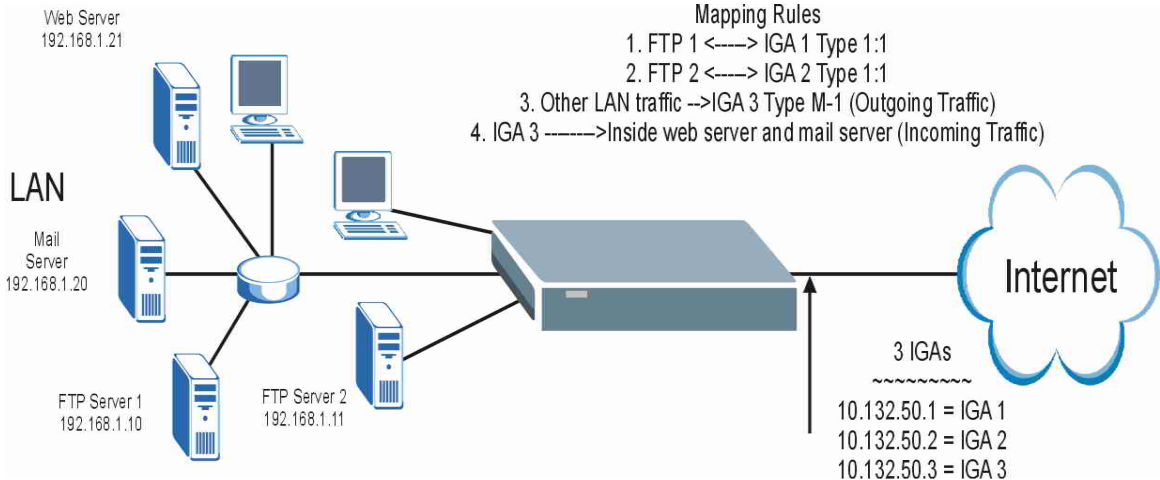

Figure 32-15 NAT Example 3

- Step 1.** In this case you need to configure Address Mapping Set 1 from **Menu 15.1 - Address Mapping Sets**. Therefore you must choose the **Full Feature** option from the **Network Address Translation** field (in menu 4 or menu 11.3) in *Figure 32-16*.
- Step 2.** Then enter 15 from the main menu.
- Step 3.** Enter 1 to configure the Address Mapping Sets.
- Step 4.** Enter 1 to begin configuring this new set. Enter a Set Name, choose the **Edit Action** and then enter 1 for the **Select Rule** field. Press [ENTER] to confirm.
- Step 5.** Select **Type** as **One-to-One** (direct mapping for packets going both ways), and enter the local **Start IP** as 192.168.1.10 (the IP address of FTP Server 1), the global **Start IP** as 10.132.50.1 (our first IGA). (See *Figure 32-17*).
- Step 6.** Repeat the previous step for rules 2 to 4 as outlined above.
- Step 7.** When finished, menu 15.1.1 should look like as shown in .

```
Menu 11.3 - Remote Node Network Layer Options

IP Options:                               Bridge Options:
IP Address Assignment= Static              Ethernet Addr Timeout (min)= 0
Rem IP Addr: 0.0.0.0
Rem Subnet Mask= 0.0.0.0
My WAN Addr= 0.0.0.0
NAT= Full Feature
  Address Mapping Set= 2
Metric= 2
Private= No
RIP Direction= Both
  Version= RIP-2B
Multicast= IGMP-v2
IP Policies=

Press ENTER to Confirm or ESC to Cancel:
```

Figure 32-16 Example 3: Menu 11.3

The following figures show how to configure the first rule

```

Menu 15.1.1.1 Address Mapping Rule

Type= One-to-One

Local IP:
  Start= 192.168.1.10
  End = N/A

Global IP:
  Start= 10.132.50.1
  End = N/A

Server Mapping Set= N/A

Press ENTER to Confirm or ESC to Cancel:

Press Space Bar to Toggle.
    
```

Figure 32-17 Example 3: Menu 15.1.1.1

```

Menu 15.1.1 - Address Mapping Rules

Set Name= Example3

Idx  Local Start IP  Local End IP  Global Start IP  Global End IP  Type
-----
1. 192.168.1.10      10.132.50.1   1-1
2. 192.168.1.11      10.132.50.2   1-1
3. 0.0.0.0           255.255.255.255 10.132.50.3   M-1
4.                               10.132.50.3   Server
5.
6.
7.
8.
9.
10.

Action= Edit      Select Rule=

Press ENTER to Confirm or ESC to Cancel:
    
```

Figure 32-18 Example 3: Final Menu 15.1.1

Now configure the IGA3 to map to our web server and mail server on the LAN.

Step 8. Enter 15 from the main menu.

Step 9. Enter 2 in **Menu 15 - NAT Setup**.

Step 10. Enter 1 in **Menu 15.2 - NAT Server Sets** to see the following menu. Configure it as shown.

Menu 15.2.1 - NAT Server Setup

Rule	Start Port No.	End Port No.	IP Address
1.	Default	Default	0.0.0.0
2.	80	80	192.168.1.21
3.	25	25	192.168.1.20
4.	0	0	0.0.0.0
5.	0	0	0.0.0.0
6.	0	0	0.0.0.0
7.	0	0	0.0.0.0
8.	0	0	0.0.0.0
9.	0	0	0.0.0.0
10.	0	0	0.0.0.0
11.	0	0	0.0.0.0
12.	0	0	0.0.0.0

Press ENTER to Confirm or ESC to Cancel:

Example 3: Menu 15.2.1

32.5.4 Example 4: NAT Unfriendly Application Programs

Some applications do not support NAT Mapping using TCP or UDP port address translation. In this case it is better to use **Many-to-Many No Overload** mapping as port numbers do *not* change for **Many-to-Many No Overload** (and **One-to-One**) NAT mapping types. The following figure illustrates this.

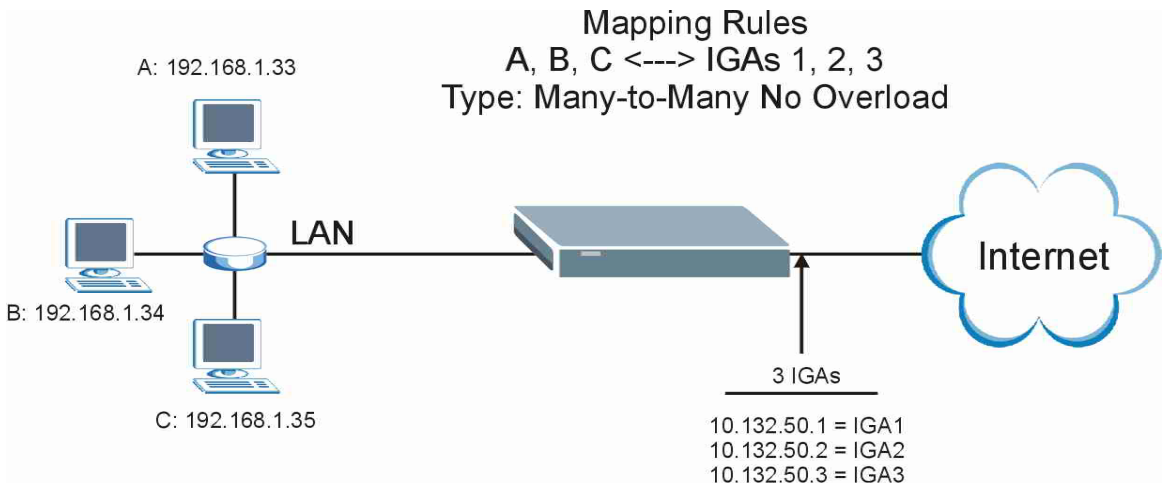

Figure 32-19 NAT Example 4

Other applications such as some gaming programs are NAT unfriendly because they embed addressing information in the data stream. These applications won't work through NAT even when using One-to-One and Many-to-Many No Overload mapping types.

Follow the steps outlined in example 3 to configure these two menus as follows.

```

Menu 15.1.1.1 Address Mapping Rule

Type= Many-to-Many No Overload

Local IP:
  Start= 192.168.1.10
  End = 192.168.1.12

Global IP:
  Start= 10.132.50.1
  End = 10.132.50.3

Server Mapping Set= N/A

Press ENTER to Confirm or ESC to Cancel:
    
```

Figure 32-20 Example 4: Menu 15.1.1.1 Address Mapping Rule

After you've configured your rule, you should be able to check the settings in menu 15.1.1 as shown next.

```

Menu 15.1.1 - Address Mapping Rules

Set Name= Example4

Idx  Local Start IP  Local End IP  Global Start IP  Global End IP  Type
----  -
1.   192.168.1.10    192.168.1.12  10.132.50.1     10.132.50.3   M:M NO OV
2.
3.
4.
5.
6.
7.
8.
9.
10.

Action= Edit          Select Rule=

Press ENTER to Confirm or ESC to Cancel:
    
```

Figure 32-21 Example 4: Menu 15.1.1 Address Mapping Rules

Chapter 33

Enabling the Firewall

This chapter shows you how to get started with the Prestige firewall.

33.1 Remote Management and the Firewall

When SMT menu 24.11 is configured to allow management (see the *Remote Management* chapter) and the firewall is enabled:

- The firewall blocks remote management from the WAN unless you configure a firewall rule to allow it.
- The firewall allows remote management from the LAN.

33.2 Access Methods

The web configurator is, by far, the most comprehensive firewall configuration tool your Prestige has to offer. For this reason, it is recommended that you configure your firewall using the web configurator, see the following chapters for instructions. SMT screens allow you to activate the firewall and view firewall logs.

33.3 Enabling the Firewall

From the main menu enter 21 to go to **Menu 21 - Filter Set and Firewall Configuration** to display the screen shown next.

Enter option 2 in this menu to bring up the following screen. Press [SPACE BAR] and then [ENTER] to select **Yes** in the **Active** field to activate the firewall. The firewall must be active to protect against Denial of Service (DoS) attacks. Additional rules may be configured using the web configurator.

```
Menu 21.2 - Firewall Setup

The firewall protects against Denial of Service (DOS) attacks when
it is active. The default Policy sets

    1. allow all sessions originating from the LAN to the WAN and
    2. deny all sessions originating from the WAN to the LAN

You may define additional Policy rules or modify existing ones but
please exercise extreme caution in doing so

Active: Yes

LAN-to-WAN Set Name: ACL Default Set
WAN-to-LAN Set Name: ACL Default Set

Please configure the Firewall function through Web Configurator.

Press ENTER to Confirm or ESC to Cancel:
```

Figure 33-1 Menu 21.2 Firewall Setup

Use the web configurator or the command interpreter to configure the firewall rules.

Part X:

SMT Advanced Management

This part discusses filtering setup, SNMP, system security, system information and diagnosis, firmware and configuration file maintenance, system maintenance, remote management, IP Policy Routing and call scheduling.

See the web configurator parts of this guide for background information on features configurable by web configurator and SMT.

Chapter 34

Filter Configuration

This chapter shows you how to create and apply filters.

34.1 About Filtering

Your Prestige uses filters to decide whether or not to allow passage of a data packet and/or to make a call. There are two types of filter applications: data filtering and call filtering. Filters are subdivided into device and protocol filters, which are discussed later.

Data filtering screens data to determine if the packet should be allowed to pass. Data filters are divided into incoming and outgoing filters, depending on the direction of the packet relative to a port. Data filtering can be applied on either the WAN side or the Ethernet side. Call filtering is used to determine if a packet should be allowed to trigger a call.

Outgoing packets must undergo data filtering before they encounter call filtering. Call filters are divided into two groups, the built-in call filters and user-defined call filters. Your Prestige has built-in call filters that prevent administrative, for example, RIP packets from triggering calls. These filters are always enabled and not accessible to you. Your Prestige applies the built-in filters first and then the user-defined call filters, if applicable, as shown next.

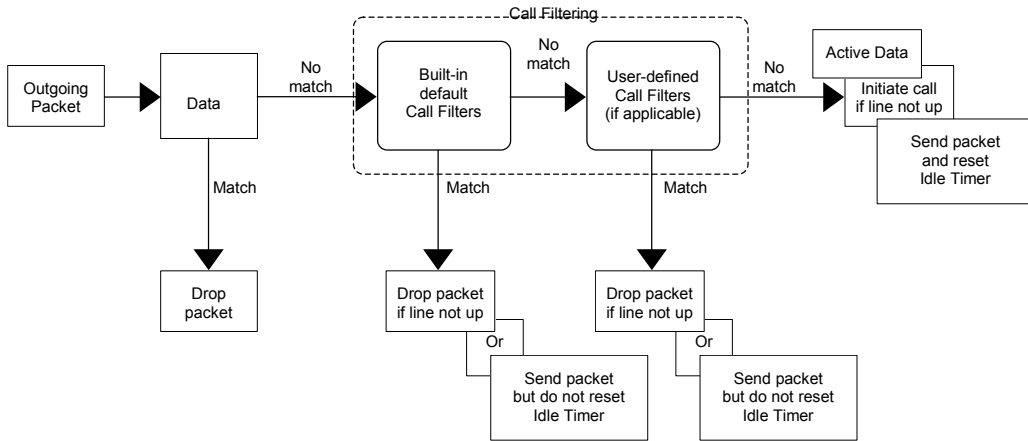

Figure 34-1 Outgoing Packet Filtering Process

Two sets of factory filter rules have been configured in menu 21 to prevent NetBIOS traffic from triggering calls. A summary of their filter rules is shown in the figures that follow.

The following figure illustrates the logic flow when executing a filter rule.

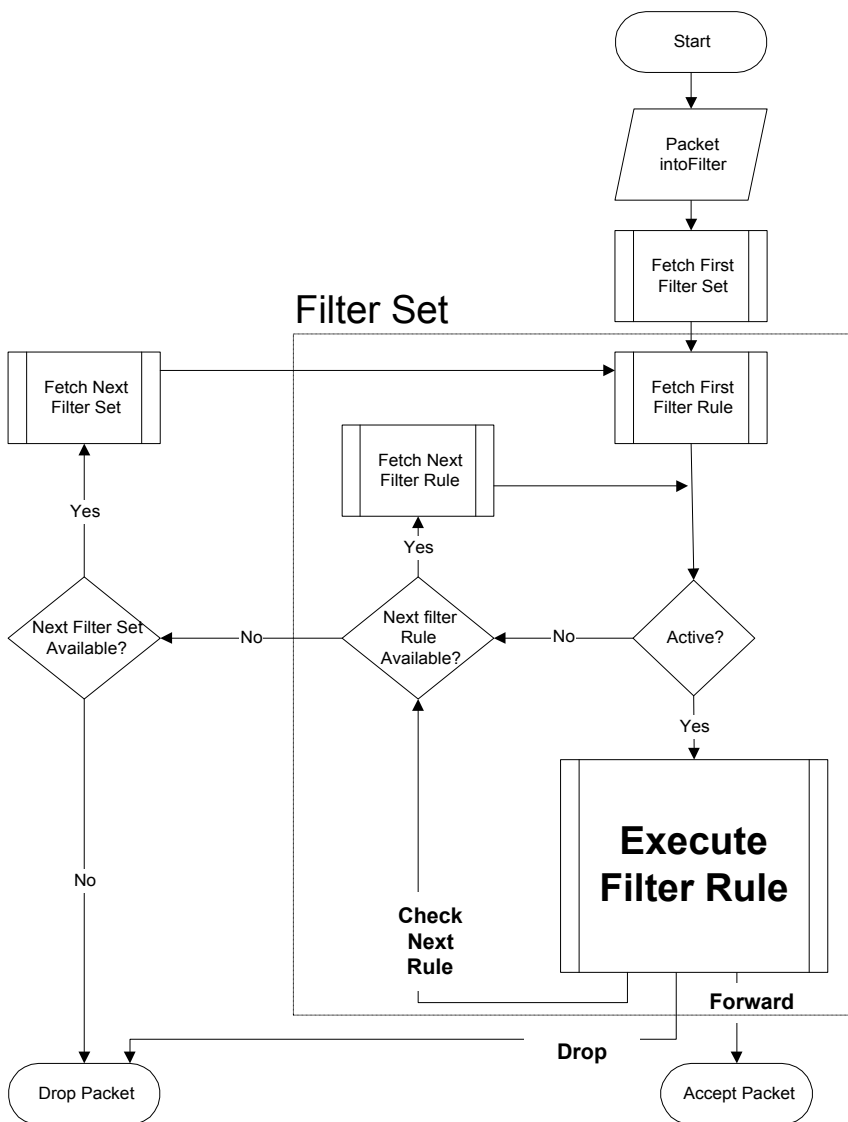

Figure 34-2 Filter Rule Process

You can apply up to four filter sets to a particular port to block various types of packets. Because each filter set can have up to six rules, you can have a maximum of 24 rules active for a single port.

For incoming packets, your Prestige applies data filters only. Packets are processed depending on whether a match is found. The following sections describe how to configure filter sets.

The Filter Structure of the Prestige

A filter set consists of one or more filter rules. Usually, you would group related rules, for example, all the rules for NetBIOS, into a single set and give it a descriptive name. You can configure up to twelve filter sets with six rules in each set, for a total of 72 filter rules in the system.

34.2 Configuring a Filter Set for the Prestige

To configure a filter set, follow the steps shown next.

Step 1. Enter 21 in the main menu to display **Menu 21 – Filter and Firewall Setup**.

Step 2. Enter 1 to display **Menu 21.1 – Filter Set Configuration** as shown next.

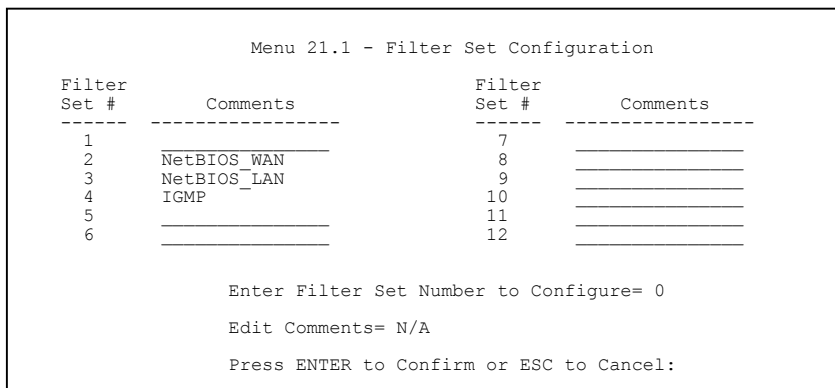

Figure 34-3 Menu 21 Filter Set Configuration

Step 3. Type the filter set to configure (no. 1 to 12) and press [ENTER].

Step 4. Type a descriptive name or comment in the **Edit Comments** field and press [ENTER].

Step 5. Press [ENTER] at the message “Press ENTER to confirm...” to display **Menu 21.1.1 – Filter Rules Summary** (that is, if you selected filter set 1 in menu 21.1).

```

Menu 21.1.2 - Filter Rules Summary

# A Type                Filter Rules                M m n
- - - - -
1 Y IP  Pr=6, SA=0.0.0.0, DA=0.0.0.0, DP=137      N D N
2 Y IP  Pr=6, SA=0.0.0.0, DA=0.0.0.0, DP=138      N D N
3 Y IP  Pr=6, SA=0.0.0.0, DA=0.0.0.0, DP=139      N D N
4 Y IP  Pr=17, SA=0.0.0.0, DA=0.0.0.0, DP=137     N D N
5 Y IP  Pr=17, SA=0.0.0.0, DA=0.0.0.0, DP=138     N D N
6 Y IP  Pr=17, SA=0.0.0.0, DA=0.0.0.0, DP=139     N D F

Enter Filter Rule Number (1-6) to Configure:

```

Figure 34-4 NetBIOS_WAN Filter Rules Summary

```

Menu 21.1.3 - Filter Rules Summary

# A Type                Filter Rules                M m n
- - - - -
1 Y IP  Pr=17, SA=0.0.0.0, SP=137, DA=0.0.0.0, DP=53  N D F
2 N
3 N
4 N
5 N
6 N

Enter Filter Rule Number (1-6) to Configure:

```

Figure 34-5 NetBIOS_LAN Filter Rules Summary

```

Menu 21.1.4 - Filter Rules Summary

# A Type                Filter Rules                M m n
- - - - -
1 Y Gen  Off=0, Len=3, Mask=ffffff, Value=01005e     N D F
2 N
3 N
4 N
5 N
6 N

Enter Filter Rule Number (1-6) to Configure:

```

Figure 34-6 IGMP Filter Rules Summary

34.3 Configuring a Filter Set for the Prestige

To configure a filter set, follow the steps shown next.

Step 1. Enter 21 in the main menu to display **Menu 21 – Filter and Firewall Setup**.

Step 2. Enter 1 to display **Menu 21.1 – Filter Set Configuration** as shown next.

```

Menu 21.1 - Filter Set Configuration

Filter          Filter
Set #          Set #
-----          -----
1              7
2              8
3      NetBIOS_WAN      9
4      NetBIOS_LAN     10
5      PPPoE           11
6      TEL_FTP_WEB_SNM 12
              -----

Enter Filter Set Number to Configure= 0

Edit Comments= N/A

Press ENTER to Confirm or ESC to Cancel:

```

Figure 34-7 Menu 21 Filter Set Configuration

Step 3. Type the filter set to configure (no. 1 to 12) and press [ENTER].

Step 4. Type a descriptive name or comment in the **Edit Comments** field and press [ENTER].

Step 5. Press [ENTER] at the message “Press ENTER to confirm...” to display **Menu 21.1.1 – Filter Rules Summary** (that is, if you selected filter set 1 in menu 21.1).

See *Figure 34-4* for the summary of the NetBIOS WAN rules and *Figure 34-5* for the summary of the NetBIOS LAN rules.

```

Menu 21.1.4 - Filter Rules Summary

# A Type                Filter Rules                M m n
- - - - -
1 Y Gen  Off=12, Len=2, Mask=ffff, Value=8863  N F N
2 Y Gen  Off=12, Len=2, Mask=ffff, Value=8864  N F D
3 N
4 N
5 N
6 N

Enter Filter Rule Number (1-6) to Configure:

```

Figure 34-8 PPPoE Filter Rules Summary

```

Menu 21.1.5 - Filter Rules Summary

# A Type                Filter Rules                M m n
- - - - -
1 Y IP   Pr=6, SA=0.0.0.0, DA=0.0.0.0, DP=23  N D N
2 Y IP   Pr=6, SA=0.0.0.0, DA=0.0.0.0, DP=21  N D N
3 Y IP   Pr=6, SA=0.0.0.0, DA=0.0.0.0, DP=80  N D N
4 Y IP   Pr=17, SA=0.0.0.0, DA=0.0.0.0, DP=69  N D N
5 Y IP   Pr=17, SA=0.0.0.0, DA=0.0.0.0, DP=161 N D N
6 Y IP   Pr=17, SA=0.0.0.0, DA=0.0.0.0, DP=162 N D F

Enter Filter Rule Number (1-6) to Configure:

```

Figure 34-9 TEL_FTP_WEB_SNM Filter Rules Summary

34.4 Filter Rules Summary Menus

The following tables briefly describe the abbreviations used in menus 21.1.1 and 21.1.2.

Table 34-1 Abbreviations Used in the Filter Rules Summary Menu

FIELD	DESCRIPTION
#	The filter rule number: 1 to 6.
A	Active: "Y" means the rule is active. "N" means the rule is inactive.
Type	The type of filter rule: "GEN" for Generic, "IP" for TCP/IP.
Filter Rules	These parameters are displayed here.

Table 34-1 Abbreviations Used in the Filter Rules Summary Menu

FIELD	DESCRIPTION
M	More. “Y” means there are more rules to check which form a rule chain with the present rule. An action cannot be taken until the rule chain is complete. “N” means there are no more rules to check. You can specify an action to be taken for instance, forward the packet, drop the packet or check the next rule. For the latter, the next rule is independent of the rule just checked.
m	Action Matched. “F” means to forward the packet immediately and skip checking the remaining rules. “D” means to drop the packet. “N” means to check the next rule.
n	Action Not Matched. “F” means to forward the packet immediately and skip checking the remaining rules. “D” means to drop the packet. “N” means to check the next rule.

The protocol dependent filter rules abbreviation are listed as follows:

Table 34-2 Rule Abbreviations Used

FILTER TYPE	DESCRIPTION
IP	
Pr	Protocol
SA	Source Address
SP	Source Port Number
DA	Destination Address
DP	Destination Port Number
GEN	
Off	Offset
Len	Length

34.5 Configuring a Filter Rule

To configure a filter rule, type its number in **Menu 21.1.x – Filter Rules Summary** and press [ENTER] to open menu 21.1.x.1 for the rule.

There are two types of filter rules: **TCP/IP** and **Generic**. Depending on the type of rule, the parameters for each type will be different. Use [SPACE BAR] to select the type of rule that you want to create in the **Filter Type** field and press [ENTER] to open the respective menu.

To speed up filtering, all rules in a filter set must be of the same class, for instance, protocol filters or generic filters. The class of a filter set is determined by the first rule that you create. When applying the filter sets to a port, separate menu fields are provided for protocol and device filter sets. If you include a protocol filter set in a device filters field or vice versa, the Prestige will warn you and will not allow you to save.

34.5.1 TCP/IP Filter Rule

This section shows you how to configure a TCP/IP filter rule. TCP/IP rules allow you to base the rule on the fields in the IP and the upper layer protocol, for example, UDP and TCP headers.

To configure TCP/IP rules, select TCP/IP Filter Rule from the **Filter Type** field and press [ENTER] to open **Menu 21.1.x.1 – TCP/IP Filter Rule**, as shown next.

```

Menu 21.1.1.1 - TCP/IP Filter Rule

Filter #: 1,1
Filter Type= TCP/IP Filter Rule
Active= No
IP Protocol= 0      IP Source Route= No
Destination: IP Addr=
              IP Mask=
              Port #=
              Port # Comp= None
Source: IP Addr=
        IP Mask=
        Port #=
        Port # Comp= None
TCP Estab= N/A
More= No          Log= None
Action Matched= Check Next Rule
Action Not Matched= Check Next Rule

Press ENTER to Confirm or ESC to Cancel:
Press Space Bar to Toggle.
```

Figure 34-10 Menu 21.1.x.1 TCP/IP Filter Rule

The following table describes how to configure your TCP/IP filter rule.

Table 34-3 Menu 21.1.x.1 TCP/IP Filter Rule

FIELD	DESCRIPTION	EXAMPLE
Filter #	This is the filter set, filter rule coordinates, for instance, 2, 3 refers to the second filter set and the third filter rule of that set.	1,1
Filter Type	Use [SPACE BAR] and then [ENTER] to choose a rule. Parameters displayed for each type will be different. Choices are TCP/IP Filter Rule , Generic Filter Rule .	TCP/IP Filter Rule
Active	Select Yes to activate or No to deactivate the filter rule.	No (default)
IP Protocol	This is the upper layer protocol, for example, TCP is 6, UDP is 17 and ICMP is 1. The value must be between 0 and 255. A value of 0 matches ANY protocol.	0 to 255
IP Source Route	IP Source Route is an optional header that dictates the route an IP packet takes from its source to its destination. If Yes , the rule applies to any packet with an IP source route. The majority of IP packets do not have source route.	No (default)
Destination: IP Addr	Type the destination IP address of the packet you want to filter. This field is ignored if it is 0.0.0.0.	IP address
IP Mask	Type the IP mask to apply to the Destination: IP Addr field.	IP mask
Port #	Type the destination port of the packets you want to filter. The field range is 0 to 65535. A 0 field is ignored.	0 to 65535
Port # Comp	Select the comparison to apply to the destination port in the packet against the value given in Destination: Port # . Choices are None , Less , Greater , Equal or Not Equal .	None
Source: IP Addr	Type the source IP Address of the packet you want to filter. A 0.0.0.0 field is ignored.	IP address
IP Mask	Type the IP mask to apply to the Source: IP Addr field.	IP mask
Port #	Type the source port of the packets you want to filter. The range of this field is 0 to 65535. A 0 field is ignored.	0 to 65535
Port # Comp	Select the comparison to apply to the source port in the packet against the value given in Source: Port # field. Choices are None , Less , Greater , Equal or Not Equal .	None

Table 34-3 Menu 21.1.x.1 TCP/IP Filter Rule

FIELD	DESCRIPTION	EXAMPLE
TCP Estab	This applies only when the IP Protocol field is 6, TCP. If Yes , the rule matches packets that want to establish TCP connection(s) (SYN=1 and ACK=0); else it is ignored.	No (default)
More	If Yes , a matching packet is passed to the next filter rule before an action is taken or else the packet is disposed of according to the action fields. If More is Yes , then Action Matched and Action Not Matched will be N/A.	No (default)
Log	Select the logging option from the following: None – No packets will be logged. Action Matched – Only packets that match the rule parameters will be logged. Action Not Matched – Only packets that do not match the rule parameters will be logged. Both – All packets will be logged.	None
Action Matched	Select the action for a matching packet. Choices are Check Next Rule , Forward or Drop .	Check Next Rule (default)
Action Not Matched	Select the action for a packet not matching the rule. Choices are Check Next Rule , Forward or Drop .	Check Next Rule (default)
When you have completed this menu, press [ENTER] at the prompt "Press ENTER to confirm or ESC to cancel" to save your configuration or press [ESC] to cancel and go back to the previous screen.		

The following figure illustrates the logic flow of an IP filter.

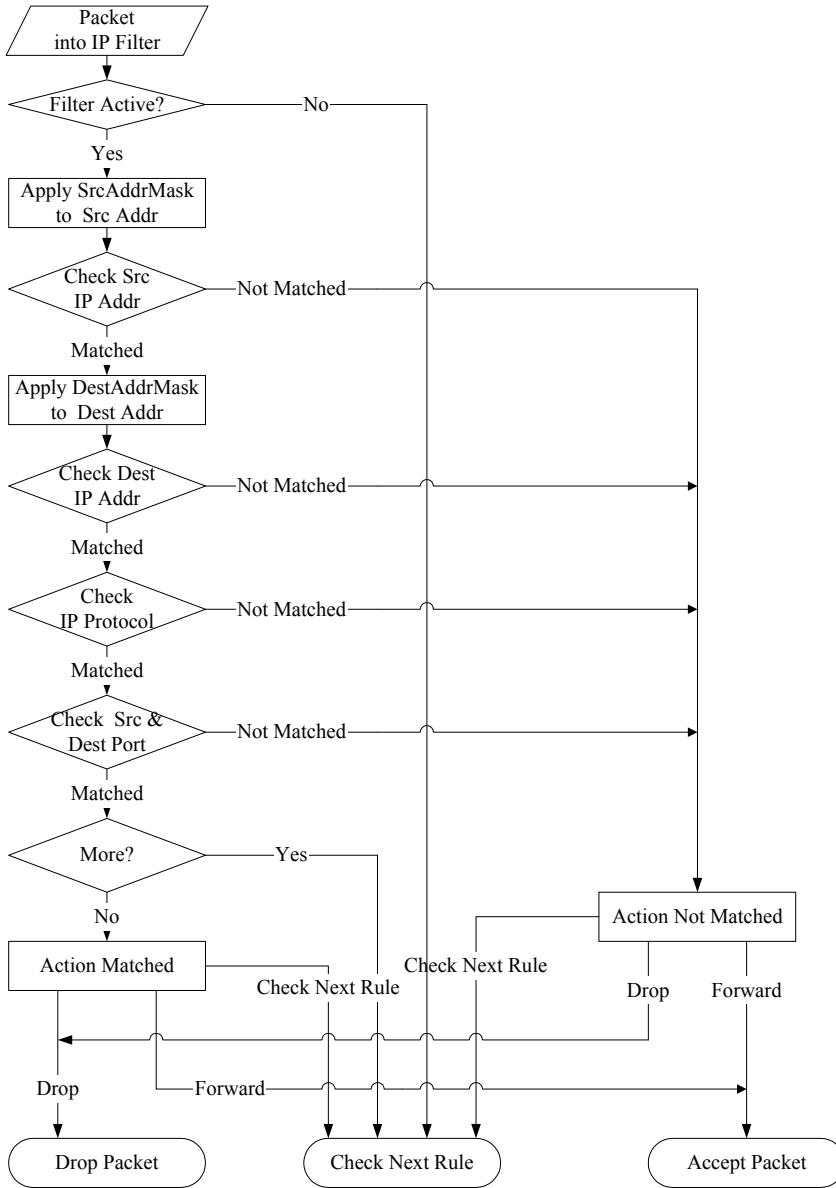

Figure 34-11 Executing an IP Filter

34.5.2 Generic Filter Rule

This section shows you how to configure a generic filter rule. The purpose of generic rules is to allow you to filter non-IP packets. For IP, it is generally easier to use the IP rules directly.

For generic rules, the Prestige treats a packet as a byte stream as opposed to an IP packet. You specify the portion of the packet to check with the **Offset** (from 0) and the **Length** fields, both in bytes. The Prestige applies the Mask (bit-wise ANDing) to the data portion before comparing the result against the Value to determine a match. The **Mask** and **Value** fields are specified in hexadecimal numbers. Note that it takes two hexadecimal digits to represent a byte, so if the length is 4, the value in either field will take 8 digits, for example, FFFFFFFF.

To configure a generic rule select an empty filter set in menu 21, for example 5. Select **Generic Filter Rule** in the **Filter Type** field and press [ENTER] to open **Menu 21.1.5.1 – Generic Filter Rule**, as shown in the following figure.

```
Menu 21.1.5.1 - Generic Filter Rule

Filter #: 5,1
Filter Type= Generic Filter Rule
Active= No
Offset= 0
Length= 0
Mask= N/A
Value= N/A
More= No           Log= None
Action Matched= Check Next Rule
Action Not Matched= Check Next Rule

Press ENTER to Confirm or ESC to Cancel:

Press Space Bar to Toggle.
```

Figure 34-12 Menu 21.1.5.1 Generic Filter Rule

The next table describes the fields in the Generic Filter Rule menu.

Table 34-4 Menu 21.1.5.1 Generic Filter Rule

FIELD	DESCRIPTION	EXAMPLE
Filter #	This is the filter set, filter rule coordinates, for instance, 2, 3 refers to the second filter set and the third rule of that set.	5,1
Filter Type	Press [SPACE BAR] and then [ENTER] to select a type of rule. Parameters displayed below each type will be different. Choices are Generic Filter Rule or TCP/IP Filter Rule .	Generic Filter Rule
Active	Select Yes to turn on or No to turn off the filter rule.	No (default)
Offset	Type the starting byte of the data portion in the packet that you want to compare. The range for this field is from 0 to 255.	0 (default)
Length	Type the byte count of the data portion in the packet that you want to compare. The range for this field is 0 to 8.	0 (default)
Mask	Type the mask (in Hexadecimal) to apply to the data portion before comparison.	
Value	Type the value (in Hexadecimal) to compare with the data portion.	
More	If Yes , a matching packet is passed to the next filter rule before an action is taken or else the packet is disposed of according to the action fields. If More is Yes , then Action Matched and Action Not Matched will be N/A .	No (default)
Log	Select the logging option from the following: None – No packets will be logged. Action Matched – Only matching packets and rules will be logged. Action Not Matched – Only packets that do not match the rule parameters will be logged. Both – All packets will be logged.	None
Action Matched	Select the action for a matching packet. Choices are Check Next Rule , Forward or Drop .	Check Next Rule (default)
Action Not Matched	Select the action for a packet not matching the rule. Choices are Check Next Rule , Forward or Drop .	Check Next Rule (default)
When you have completed this menu, press [ENTER] at the prompt "Press ENTER to confirm or ESC to cancel" to save your configuration or press [ESC] to cancel and go back to the previous screen.		

34.6 Filter Types and NAT

There are two classes of filter rules, **Generic Filter** Device rules and Protocol Filter (**TCP/IP**) rules. Generic Filter rules act on the raw data from/to LAN and WAN. Protocol Filter rules act on IP packets.

When NAT (Network Address Translation) is enabled, the inside IP address and port number are replaced on a connection-by-connection basis, which makes it impossible to know the exact address and port on the wire. Therefore, the Prestige applies the protocol filters to the “native” IP address and port number before NAT for outgoing packets and after NAT for incoming packets. On the other hand, the generic (or device) filters are applied to the raw packets that appear on the wire. They are applied at the point where the Prestige is receiving and sending the packets; for instance, the interface. The interface can be an Ethernet, or any other hardware port. The following figure illustrates this.

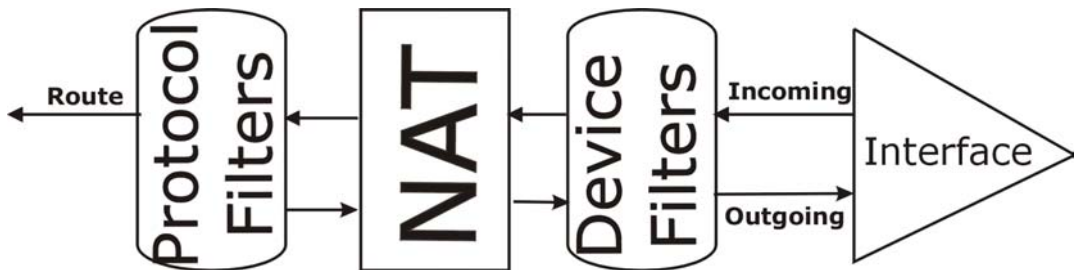

Figure 34-13 Protocol and Device Filter Sets

34.7 Example Filter

Let's look at an example to block outside users from telnetting into the Prestige.

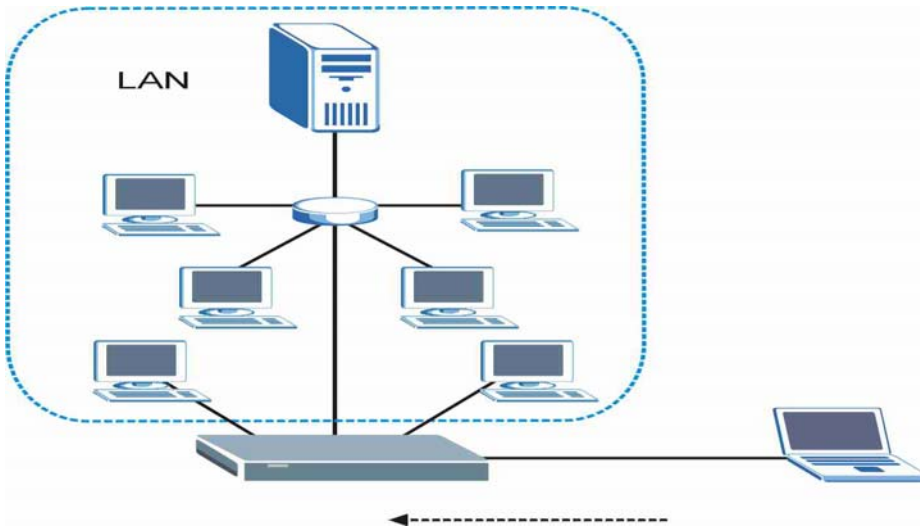

Figure 34-14 Sample Telnet Filter

- Step 1.** Enter 1 in the menu 21 to display **Menu 21.1 — Filter Set Configuration**.
- Step 2.** Enter the index number of the filter set you want to configure (in this case 6).
- Step 3.** Type a descriptive name or comment in the **Edit Comments** field (for example, TELNET_WAN) and press [ENTER].

Step 4. Press [ENTER] at the message “Press [ENTER] to confirm or [ESC] to cancel” to open **Menu 21.1.6 — Filter Rules Summary**.

Step 5. Type 1 to configure the first filter rule. Make the entries in this menu as shown next.

When you press [ENTER] to confirm, the following screen appears. Note that there is only one filter rule in this set.

```

Menu 21.1.6.1 - TCP/IP Filter Rule

Filter #: 6,1
Filter Type= TCP/IP Filter Rule
Active= Yes
IP Protocol= 6          IP Source Route= No
Destination: IP Addr= 0.0.0.0
                IP Mask= 0.0.0.0
                Port # = 23
                Port # Comp= Equal
Source: IP Addr= 0.0.0.0
                IP Mask= 0.0.0.0
                Port # =
                Port # Comp= Equal
TCP Estab= No
More= No              Log= None
Action Matched= Drop
Action Not Matched= Forward

Press ENTER to Confirm or ESC to Cancel:

```

Press [SPACE BAR] to choose this filter rule type. The first filter rule type determines all subsequent filter types within a set.

Select **Yes** to make the rule active.

6 is the TCP protocol.

The port number for the telnet service (TCP protocol) is **23**. See RFC-1060 for port numbers of well-known services.

There are no more rules to check.

Select **Drop** here so that the packet will be dropped if its destination is the telnet port.

Select **Equal** here as we are looking for packets going to port 23 only.

Select **Forward** here so that the packet will be forwarded if its destination is not the telnet port and there are no more rules in this filter set to check. Select **Next** if there are more rules to check.

Figure 34-15 Menu 21.1.6.1 Sample Filter

Menu 21.1.6 - Filter Rules Summary

#	A	Type	Filter Rules	M	m	n
1	Y	IP	Pr=6, SA=0.0.0.0, DA=0.0.0.0, DP=23	N	D	F
2	N					
3	N					
4	N					
5	N					
6	N					

Enter Filter Rule Number (1-6) to Configure: 1

Callout 1: This shows you that you have configured and activated (**A = Y**) a TCP/IP filter rule (**Type = IP, Pr = 6**) for destination telnet ports (**DP = 23**).

Callout 2: **M = N** means an action can be taken immediately. The action is to drop the packet (**m = D**) if the action is matched and to forward the packet immediately (**n = F**) if the action is not matched no matter whether there are more rules to be checked (there aren't in this example).

Figure 34-16 Menu 21.1.6.1 Sample Filter Rules Summary

After you have created the filter set, you must apply it.

- Step 1.** Enter 11 in the main menu to display menu 11 and type the remote node number to edit.
- Step 2.** Go to the **Edit Filter Sets** field, press [SPACE BAR] to choose **Yes** and press [ENTER].
- Step 3.** This brings you to menu 11.5. Apply the example filter set (for example, filter set 3) in this menu as shown in the next section.

34.8 Applying Filters and Factory Defaults

This section shows you where to apply the filter(s) after you design it (them). Sets of factory default filter rules have been configured in menu 21 (but have not been applied) to filter traffic.

Table 34-5 Filter Sets Table

FILTER SETS	DESCRIPTION
Input Filter Sets:	Apply filters for incoming traffic. You may apply protocol or device filter rules. See earlier in this chapter for information on filters.
Output Filter Sets:	Apply filters for traffic leaving the Prestige. You may apply filter rules for protocol or device filters. See earlier in this section for information on types of filters.
Call Filter Sets:	Apply filters to decide if a packet should be allowed to trigger a call.

34.8.1 Ethernet Traffic

You seldom need to filter Ethernet traffic; however, the filter sets may be useful to block certain packets, reduce traffic and prevent security breaches. Go to menu 3.1 (shown next) and type the number(s) of the filter set(s) that you want to apply as appropriate. You can choose up to four filter sets (from twelve) by typing their numbers separated by commas, for example, 3, 4, 6, 11. The factory default filter set, NetBIOS_LAN, is inserted in the **protocol filters** field under **Input Filter Sets** in menu 3.1 in order to prevent local NetBIOS messages from triggering calls to the DNS server.

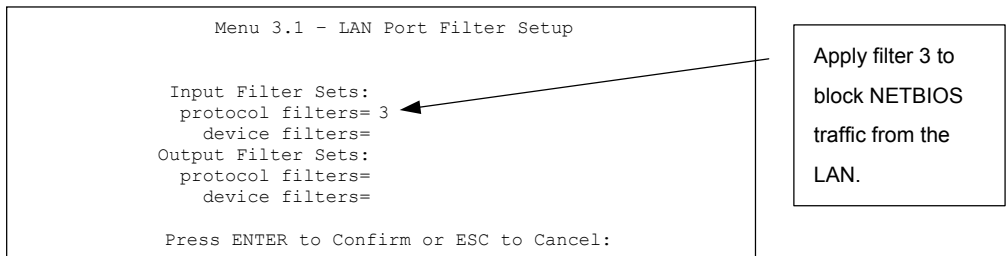

Figure 34-17 Filtering Ethernet Traffic

34.8.2 Remote Node Filters

Go to menu 11.5 (shown next) and type the number(s) of the filter set(s) as appropriate. You can cascade up to four filter sets by typing their numbers separated by commas. The factory default filter set, NetBIOS_WAN, is inserted in the **protocol filters** field under **Call Filter Sets** in menu 11.5 to block local NetBIOS traffic from triggering calls to the ISP.

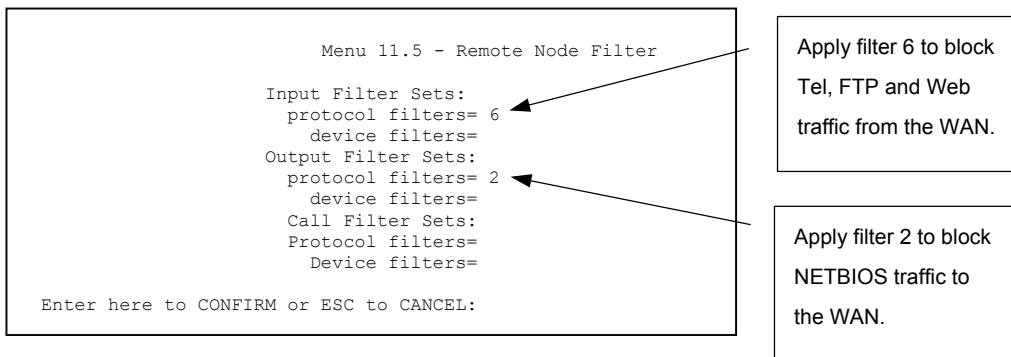

Figure 34-18 Filtering Remote Node Traffic

Note that call filter sets are visible when you select PPPoA or PPPoE encapsulation.

Chapter 35

SNMP Configuration

This chapter explains SNMP Configuration menu 22.

35.1 About SNMP

Simple Network Management Protocol is a protocol used for exchanging management information between network devices. SNMP is a member of the TCP/IP protocol suite. Your Prestige supports SNMP agent functionality, which allows a manager station to manage and monitor the Prestige through the network. The Prestige supports SNMP version one (SNMPv1) and version two c (SNMPv2c). The next figure illustrates an SNMP management operation. SNMP is only available if TCP/IP is configured.

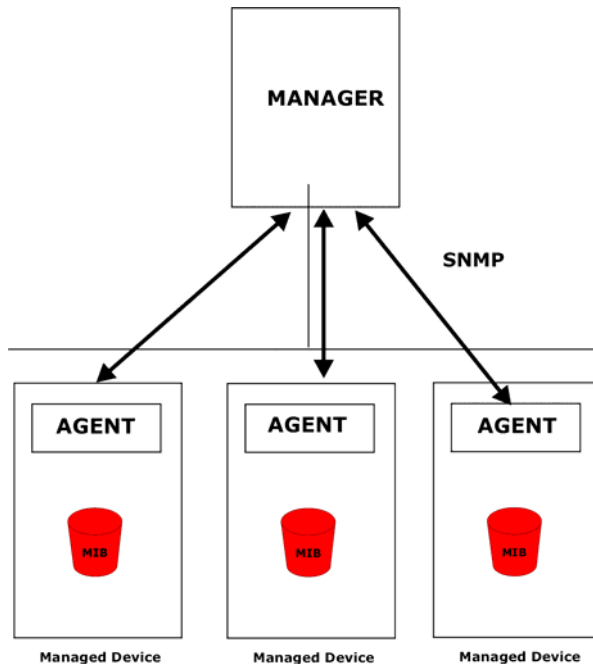

Figure 35-1 SNMP Management Model

An SNMP managed network consists of two main components: agents and a manager.

An agent is a management software module that resides in a managed device (the Prestige). An agent translates the local management information from the managed device into a form compatible with SNMP. The manager is the console through which network administrators perform network management functions. It executes applications that control and monitor managed devices.

The managed devices contain object variables/managed objects that define each piece of information to be collected about a device. Examples of variables include the number of packets received, node port status etc. A Management Information Base (MIB) is a collection of managed objects. SNMP allows a manager and agents to communicate for the purpose of accessing these objects.

SNMP itself is a simple request/response protocol based on the manager/agent model. The manager issues a request and the agent returns responses using the following protocol operations:

- Get - Allows the manager to retrieve an object variable from the agent.
- GetNext - Allows the manager to retrieve the next object variable from a table or list within an agent. In SNMPv1, when a manager wants to retrieve all elements of a table from an agent, it initiates a Get operation, followed by a series of GetNext operations.
- Set - Allows the manager to set values for object variables within an agent.
- Trap - Used by the agent to inform the manager of some events.

35.2 Supported MIBs

The Prestige supports RFC-1215 and MIB II as defined in RFC-1213 as well as ZyXEL private MIBs. The focus of the MIBs is to let administrators collect statistic data and monitor status and performance.

35.3 SNMP Configuration

To configure SNMP, select option 22 from the main menu to open **Menu 22 — SNMP Configuration** as shown next. The “community” for Get, Set and Trap fields is SNMP terminology for password.

```

Menu 22 - SNMP Configuration

SNMP:
  Get Community= public
  Set Community= public
  Trusted Host= 0.0.0.0
  Trap:
    Community= public
    Destination= 0.0.0.0

Press ENTER to Confirm or ESC to Cancel:

```

Figure 35-2 Menu 22 SNMP Configuration

The following table describes the SNMP configuration parameters.

Table 35-1 Menu 22 SNMP Configuration

FIELD	DESCRIPTION	EXAMPLE
SNMP:		
Get Community	Type the Get Community , which is the password for the incoming Get- and GetNext requests from the management station.	public
Set Community	Type the Set community, which is the password for incoming Set requests from the management station.	public
Trusted Host	If you enter a trusted host, your Prestige will only respond to SNMP messages from this address. A blank (default) field means your Prestige will respond to all SNMP messages it receives, regardless of source.	0.0.0.0
Trap:		
Community	Type the trap community, which is the password sent with each trap to the SNMP manager.	public
Destination	Type the IP address of the station to send your SNMP traps to.	0.0.0.0
When you have completed this menu, press [ENTER] at the prompt "Press ENTER to confirm or ESC to cancel" to save your configuration or press [ESC] to cancel and go back to the previous screen.		

35.4 SNMP Traps

The Prestige will send traps to the SNMP manager when any one of the following events occurs:

Table 35-2 SNMP Traps

TRAP #	TRAP NAME	DESCRIPTION
1	coldStart (<i>defined in RFC-1215</i>)	A trap is sent after booting (power on).
2	warmStart (<i>defined in RFC-1215</i>)	A trap is sent after booting (software reboot).
3	linkDown (<i>defined in RFC-1215</i>)	A trap is sent with the port number when any of the links are down. See the following table.
4	linkUp (<i>defined in RFC-1215</i>)	A trap is sent with the port number.
5	authenticationFailure (<i>defined in RFC-1215</i>)	A trap is sent to the manager when receiving any SNMP gets or sets requirements with wrong community (password).
6	whyReboot (defined in ZYXEL-MIB)	A trap is sent with the reason of restart before rebooting when the system is going to restart (warm start).
6a	For intentional reboot :	A trap is sent with the message "System reboot by user!" if reboot is done intentionally, (for example, download new files, CI command "sys reboot", etc.).

The port number is its interface index under the interface group.

Table 35-3 Ports and Permanent Virtual Circuits

PORT	PVC (PERMANENT VIRTUAL CIRCUIT)
1	Ethernet LAN
2	1
3	2
...	...
13	12
14	xDSL

Chapter 36

System Security

This chapter describes how to configure the system security on the Prestige.

36.1 System Security

You can configure the system password, an external RADIUS server and IEEE802.1x in menu 23.

36.1.1 System Password

Enter 23 in the main menu to display **Menu 23 – System Security**.

You should change the default password. If you forget your password you have to restore the default configuration file. Refer to the section on changing the system password in the *Introducing the SMT* chapter and the section on resetting the Prestige in the *Introducing the Web Configurator* chapter.

```
Menu 23 - System Security

1. Change Password
2. RADIUS Server

4. IEEE802.1x
```

Figure 36-1 Menu 23 System Security

36.1.2 Configuring External RADIUS Server

From **Menu 23- System Security**, enter 2 to display **Menu 23.2 - System Security-RADIUS Server**.

```
Menu 23 - System Security

1. Change Password
2. RADIUS Server

4. IEEE802.1x
```

Figure 36-2 Menu 23 System Security

```

Menu 23.2 - System Security - RADIUS Server

Authentication Server:
Active= No
Server Address= 10.11.12.13
Port #= 1812
Shared Secret= *****

Accounting Server:
Active= No
Server Address= 10.11.12.13
Port #= 1813
Shared Secret= *****

Press ENTER to Confirm or ESC to Cancel:
    
```

Figure 36-3 Menu 23.2 System Security : RADIUS Server

The following table describes the fields in this menu.

Table 36-1 Menu 23.2 System Security : RADIUS Server

FIELD	DESCRIPTION	EXAMPLE
Authentication Server		
Active	Press [SPACE BAR] to select Yes and press [ENTER] to enable user authentication through an external authentication server.	No
Server Address	Enter the IP address of the external authentication server in dotted decimal notation.	10.11.12.13
Port	The default port of the RADIUS server for authentication is 1812 . You need not change this value unless your network administrator instructs you to do so with additional information.	1812
Shared Secret	Specify a password (up to 31 alphanumeric characters) as the key to be shared between the external authentication server and the access points. The key is not sent over the network. This key must be the same on the external authentication server and Prestige.	
Accounting Server		
Active	Press [SPACE BAR] to select Yes and press [ENTER] to enable user authentication through an external accounting server.	No
Server Address	Enter the IP address of the external accounting server in dotted decimal notation.	10.11.12.13

Table 36-1 Menu 23.2 System Security : RADIUS Server

FIELD	DESCRIPTION	EXAMPLE
Port	The default port of the RADIUS server for accounting is 1813 . You need not change this value unless your network administrator instructs you to do so with additional information.	1813
Shared Secret	Specify a password (up to 31 alphanumeric characters) as the key to be shared between the external accounting server and the access points. The key is not sent over the network. This key must be the same on the external accounting server and Prestige.	
When you have completed this menu, press [ENTER] at the prompt "Press ENTER to confirm or ESC to cancel" to save your configuration or press [ESC] to cancel and go back to the previous screen.		

36.1.3 IEEE802.1x

The IEEE802.1x standards outline enhanced security methods for both the authentication of wireless stations and encryption key management.

Follow the steps below to enable EAP authentication on your Prestige.

Step 1. From the main menu, enter 23 to display **Menu23 – System Security**.

```

Menu 23 - System Security

1. Change Password
2. RADIUS Server

4. IEEE802.1x

```

Figure 36-4 Menu 23 System Security

Step 2. Enter 4 to display **Menu 23.4 – System Security – IEEE802.1x**.

```

Menu 23.4 - System Security - IEEE802.1x

Wireless Port Control= Authentication Required
ReAuthentication Timer (in second)= 1800
Idle Timeout (in second)= 3600

Authentication Databases= Local User Database Only

Press ENTER to Confirm or ESC to Cancel:
    
```

Figure 36-5 Menu 23.4 System Security : IEEE802.1x

The following table describes the fields in this menu.

Table 36-2 Menu 23.4 System Security : IEEE802.1x

FIELD	DESCRIPTION
Wireless Port Control	<p>Press [SPACE BAR] and select a security mode for the wireless LAN access.</p> <p>Select No Authentication Required to allow any clients access to your wired network without entering usernames and passwords. This is the default setting.</p> <p>Selecting Authentication Required means clients have to enter usernames and passwords before access to the wired network is allowed.</p> <p>Select No Access Allowed to block all clients' access to the wired network.</p>
ReAuthenticati- on Timer (in seconds)	<p>Specify how often a client has to re-enter username and password to stay connected to the wired network.</p> <p>This field is activated only when you select Authentication Required in the Wireless Port Control field. Enter a time interval between 10 and 9999 (in seconds). The default time interval is 1800 seconds (or 30 minutes).</p>
Idle Timeout	<p>The Prestige automatically disconnects a client from the wired network after a period of inactivity. The client needs to enter the username and password again before access to the wired network is allowed.</p> <p>This field is activated only when you select Authentication Required in the Wireless Port Control field. The default time interval is 3600 seconds (or 1 hour).</p>

Table 36-2 Menu 23.4 System Security : IEEE802.1x

FIELD	DESCRIPTION
Authentication Databases	<p>This field is activated only when you select Authentication Required in the Wireless Port Control field.</p> <p>The authentication database contains wireless station login information. The local user database is the built-in database on the Prestige. The RADIUS is an external server. Use this field to decide which database the Prestige should use (first) to authenticate a wireless station.</p> <p>Before you specify the priority, make sure you have set up the corresponding database correctly first.</p> <p>Select Local User Database Only to have the Prestige just check the built-in user database on the Prestige for a wireless station's username and password.</p> <p>Select RADIUS Only to have the Prestige just check the user database on the specified RADIUS server for a wireless station's username and password.</p> <p>Select Local first, then RADIUS to have the Prestige first check the user database on the Prestige for a client's user name and password. If the user name is not found, the Prestige checks the user database on the specified RADIUS server.</p> <p>Select RADIUS first, then Local to have the Prestige first check the user database on the specified RADIUS server for a client's user name and password. When the user name is not found or password does not match in the RADIUS server, the Prestige will not check the local user database and the authentication fails. If the Prestige cannot reach the RADIUS server, then the Prestige checks the local user database on the Prestige.</p>
<p>When you have completed this menu, press [ENTER] at the prompt "Press ENTER to confirm or ESC to cancel" to save your configuration or press [ESC] to cancel and go back to the previous screen.</p>	

Once you enable user authentication, you need to specify an external RADIUS server or create local user accounts on the Prestige for authentication.

36.2 Creating User Accounts on the Prestige

By storing user profiles locally, your Prestige is able to authenticate wireless users without interacting with a network RADIUS server.

Follow the steps below to set up user profiles on your Prestige.

Step 2. From the main menu, enter 14 to display **Menu 14 - Dial-in User Setup**.

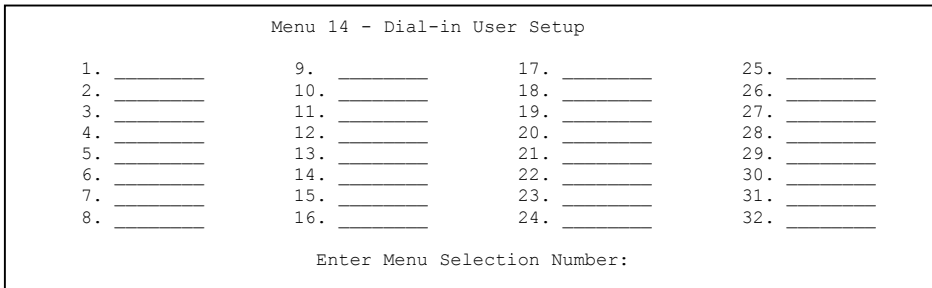

Figure 36-6 Menu 14 Dial-in User Setup

Step 3. Type a number and press [ENTER] to edit the user profile.

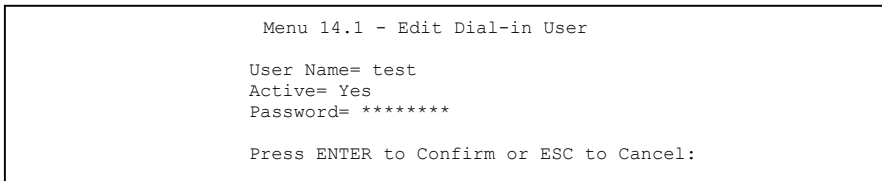

Figure 36-7 Menu 14.1 Edit Dial-in User

The following table describes the fields in this menu.

Table 36-3 Menu 14.1 Edit Dial-in User

FIELD	DESCRIPTION
User Name	Enter a username up to 31 alphanumeric characters long for this user profile. This field is case sensitive.
Active	Press [SPACE BAR] to select Yes and press [ENTER] to enable the user profile.
Password	Enter a password up to 31 characters long for this user profile.
When you have completed this menu, press [ENTER] at the prompt "Press ENTER to confirm or ESC to cancel" to save your configuration or press [ESC] to cancel and go back to the previous screen.	

Chapter 37

System Information and Diagnosis

This chapter covers the information and diagnostic tools in SMT menus 24.1 to 24.4.

These tools include updates on system status, port status, log and trace capabilities and upgrades for the system software. This chapter describes how to use these tools in detail.

Type 24 in the main menu to open **Menu 24 – System Maintenance**, as shown in the following figure.

```
Menu 24 - System Maintenance

1. System Status
2. System Information and Console Port Speed
3. Log and Trace
4. Diagnostic
5. Backup Configuration
6. Restore Configuration
7. Upload Firmware
8. Command Interpreter Mode
9. Call Control
10. Time and Date Setting
11. Remote Management

Enter Menu Selection Number:
```

Figure 37-1 Menu 24 System Maintenance

37.1 System Status

The first selection, System Status gives you information on the status and statistics of the ports, as shown next. System Status is a tool that can be used to monitor your Prestige. Specifically, it gives you information on your ADSL telephone line status, number of packets sent and received.

To get to System Status, type 24 to go to **Menu 24 — System Maintenance**. From this menu, type 1. **System Status**. There are two commands in **Menu 24.1 — System Maintenance — Status**. Entering 1 resets the counters; [ESC] takes you back to the previous screen.

The following table describes the fields present in **Menu 24.1 — System Maintenance — Status** which are read-only and meant for diagnostic purposes.

```

Menu 24.1 - System Maintenance - Status                               hh:mm:ss
                                                                    Sat. Jan. 01, 2000

Node-Lnk   Status      TxPkts   RxPkts   Errors   Tx B/s   Rx B/s   Up Time
1-1483     Up           211      0        0        0        0      0:26:20
2          N/A          0        0        0        0        0      0:00:00
3          N/A          0        0        0        0        0      0:00:00
4          N/A          0        0        0        0        0      0:00:00
5          N/A          0        0        0        0        0      0:00:00
6          N/A          0        0        0        0        0      0:00:00
7          N/A          0        0        0        0        0      0:00:00
8          N/A          0        0        0        0        0      0:00:00
ISDN-B1    Idle         0        0        0        0        0      0:00:00
ISDN-B2    Idle         0        0        0        0        0      0:00:00
My WAN IP (from ISP) :

Ethernet:
  Status: 10M/Half Duplex      Tx Pkts: 53      Line Status: Up
  Collisions: 0                Rx Pkts: 36      Upstream Speed: 0 Kbps
  CPU Load= 3.8%              Downstream Speed: 0 Kbps

WAN:

Press Command:
COMMANDS: 1-Reset Counters   ESC-Exit
    
```

Figure 37-2 Menu 24.1 System Maintenance: Status

The following table describes the fields present in **Menu 24.1 — System Maintenance — Status**.

Table 37-1 Menu 24.1 System Maintenance: Status

FIELD	DESCRIPTION
Node-Lnk	This is the node index number and link type. Link types: PPP, ENET, 1483.
Status	This shows the status of the remote node.
ISDN-B1/B2	Both ISDN channels are used by remote nodes 9 and 10 (see <i>SMT Menu 11</i>). The channel status shows Idle when the channel is inactive, Lcp up when the channel is connecting or UP when the ISDN-B1/2 Channel is active.
TxPkts	The number of transmitted packets to this remote node.
RxPkts	The number of received packets from this remote node.
Errors	The number of error packets on this connection.
Tx B/s	This shows the transmission rate in bytes per second.
Rx B/s	This shows the receiving rate in bytes per second.
Up Time	This is the time this channel has been connected to the current remote node.

Table 37-1 Menu 24.1 System Maintenance: Status

FIELD	DESCRIPTION
My WAN IP (from ISP)	This is the IP address of the ISP remote node.
Ethernet	This shows statistics for the LAN.
Status	This shows the current status of the LAN.
Tx Pkts	This is the number of transmitted packets to the LAN.
Rx Pkts	This is the number of received packets from the LAN.
Collision	This is the number of collisions.
WAN	This shows statistics for the WAN.
Line Status	This shows the current status of the xDSL line, which can be Up or Down.
Upstream Speed	This shows the upstream transfer rate in kbps.
Downstream Speed	This shows the downstream transfer rate in kbps.
CPU Load	This specifies the percentage of CPU utilization.

37.2 System Information

To get to the System Information:

- Step 3.** Enter 24 to display **Menu 24 — System Maintenance**.
- Step 4.** Enter 2 to display **Menu 24.2 — System Information**.
- Step 5.** From this menu you have two choices as shown in the next figure:

```

Menu 24.2 - System Information and Console Port Speed
  1. System Information
  2. Console Port Speed

Please enter selection:

```

Figure 37-3 Menu 24.2 System Information and Console Port Speed

37.2.1 System Information

Enter 1 in menu 24.2 to display the screen shown next.

```

Menu 24.2.1 - System Maintenance - Information

Name: 653HWI
Routing: IP
ZyNOS S/W Version: V3.40(OA.0)b5 | 09/26/2003
ADSL Chipset Vendor: Alcatel, Version 13.9.22
Standard: Multi-Mode

LAN
Ethernet Address: 00:a0:c5:46:99:91
IP Address: 192.168.1.1
IP Mask: 255.255.255.0
DHCP: Server

Press ESC or RETURN to Exit:
    
```

Figure 37-4 Menu 24.2.1 System Maintenance : Information

The following table describes the fields in this menu.

Table 37-2 Menu 24.2.1 System Maintenance : Information

FIELD	DESCRIPTION
Name	Displays the system name of your Prestige. This information can be changed in Menu 1 – General Setup .
Routing	Refers to the routing protocol used.
ZyNOS F/W Version	Refers to the ZyNOS (ZyXEL Network Operating System) system firmware version. ZyNOS is a registered trademark of ZyXEL Communications Corporation.
ADSL Chipset Vendor	Displays the vendor of the ADSL chipset and DSL version.
Standard	This refers to the operational protocol the Prestige and the DSLAM (Digital Subscriber Line Access Multiplexer) are using.
LAN	
Ethernet Address	Refers to the Ethernet MAC (Media Access Control) of your Prestige.
IP Address	This is the IP address of the Prestige in dotted decimal notation.
IP Mask	This shows the subnet mask of the Prestige.

Table 37-2 Menu 24.2.1 System Maintenance : Information

FIELD	DESCRIPTION
DHCP	This field shows the DHCP setting (None, Relay or Server) of the Prestige.

37.2.2 Console Port Speed

You can set up different port speeds for the console port through **Menu 24.2.2 – System Maintenance – Console Port Speed**. Your Prestige supports 9600 (default), 19200, 38400, 57600 and 115200 bps. Press [SPACE BAR] and then [ENTER] to select the desired speed in menu 24.2.2, as shown in the following figure.

```

Menu 24.2.2 - System Maintenance - Change Console Port Speed

Console Port Speed: 9600

Press ENTER to Confirm or ESC to Cancel:

```

Figure 37-5 Menu 24.2.2 System Maintenance : Change Console Port Speed

Once you change the Prestige consol port speed, you must also set the speed parameter for the communication software you are using to connect to the Prestige.

37.3 Log and Trace

There are two logging facilities in the Prestige. The first is the error logs and trace records that are stored locally. The second is the UNIX syslog facility for message logging.

37.3.1 Viewing Error Log

The first place you should look for clues when something goes wrong is the error log. Follow the procedures to view the local error/trace log:

- Step 1.** Type 24 in the main menu to display **Menu 24 – System Maintenance**.
- Step 2.** From menu 24, type 3 to display **Menu 24.3 – System Maintenance – Log and Trace**.

```
Menu 24.3 - System Maintenance - Log and Trace

1. View Error Log
2. UNIX Syslog
3. Accounting Server

Please enter selection
```

Figure 37-6 Menu 24.3 System Maintenance: Log and Trace

Step 3. Enter 1 from **Menu 24.3 — System Maintenance — Log and Trace** to display the error log in the system.

After the Prestige finishes displaying the error log, you will have the option to clear it. Samples of typical error and information messages are presented in the next figure.

```
59 Thu Jan 01 00:00:03 1970 PP0f INFO LAN promiscuous mode <0>
60 Thu Jan 01 00:00:03 1970 PP00 -WARN SNMP TRAP 0: cold start
61 Thu Jan 01 00:00:03 1970 PP00 INFO main: init completed
62 Thu Jan 01 00:00:19 1970 PP00 INFO SMT Session Begin
63 Thu Jan 01 00:00:24 1970 PP0a WARN MPOA Link Down
Clear Error Log (y/n):
```

Figure 37-7 Sample Error and Information Messages

37.3.2 Syslog and Accounting

The Prestige uses the UNIX syslog facility to log the CDR (Call Detail Record) and system messages to a syslog server. Syslog and accounting can be configured in **Menu 24.3.2 — System Maintenance — UNIX Syslog**, as shown next.

```

Menu 24.3.2 - System Maintenance - UNIX Syslog

UNIX Syslog:
Active= No
Syslog IP Address= ?
Log Facility= Local 1

Types:
CDR= No
Packet triggered= No
Filter Log= No
PPP Log= No

Press ENTER to Confirm or ESC to Cancel:

Press Space Bar to Toggle.
    
```

Figure 37-8 Menu 24.3.2 System Maintenance : Syslog and Accounting

You need to configure the UNIX syslog parameters described in the following table to activate syslog then choose what you want to log.

Table 37-3 Menu 24.3.2 System Maintenance : Syslog and Accounting

PARAMETER	DESCRIPTION
UNIX Syslog:	
Active	Use [SPACE BAR] and then [ENTER] to turn syslog on or off.
Syslog IP Address	Type the IP address of your syslog server.
Log Facility	Use [SPACE BAR] and then [ENTER] to select one of seven different local options. The log facility lets you log the message in different server files. Refer to your UNIX manual.
Types:	
CDR	Call Detail Record (CDR) logs all data phone line activity if set to Yes .
Packet Triggered	The first 48 bytes or octets and protocol type of the triggering packet is sent to the UNIX syslog server when this field is set to Yes .
Filter Log	No filters are logged when this field is set to No . Filters with the individual filter Log Filter field set to Yes are logged when this field is set to Yes .
PPP Log	PPP events are logged when this field is set to Yes .

The following are examples of the four types of syslog messages sent by the Prestige:

```

1 - CDR
SdcmdSyslogSend ( SYSLOG CDR, SYSLOG INFO, String);
String = board xx line xx channel xx, call xx, str
board = the hardware board ID
line = the WAN ID in a board
    
```

Channel = channel ID within the WAN
call = the call reference number which starts from 1 and increments by 1 for each new call
str = C01 Outgoing Call dev xx ch xx (dev:device No. ch:channel No.)
C01 Incoming Call xxxxBps xxxxxx (L2TP, xxxxxx = Remote Call ID)
C01 Incoming Call xxxx (= connected speed) xxxxxx (= Remote Call ID)
L02 Tunnel Connected (L2TP)
C02 OutCall Connected xxxx (= connected speed) xxxxxx (= Remote Call ID)
C02 CLID call refused
L02 Call Terminated
C02 Call Terminated
Jul 19 11:19:27 192.168.102.2 ZYXEL: board 0 line 0 channel 0, call 1, C01 Outgoing Call dev=2 ch=0 40002
Jul 19 11:19:32 192.168.102.2 ZYXEL: board 0 line 0 channel 0, call 1, C02 OutCall Connected 64000 40002
Jul 19 11:20:06 192.168.102.2 ZYXEL: board 0 line 0 channel 0, call 1, C02 Call Terminated
2 - Packet Triggered
SdcmSyslogSend (SYSLOG PKTTRI, SYSLOG NOTICE, String);
String = Packet trigger: Protocol=xx Data=xxxxxxxxxxxx...x
Protocol: (1:IP 2:IPX 3:IPXHC 4:BPDU 5:ATALK 6:IPNG)
Data: We will send forty-eight Hex characters to the server
Jul 19 11:28:39 192.168.102.2 ZYXEL: Packet Trigger: Protocol=1, Data=4500003c100100001f010004c0a86614ca849a7b08004a5c020001006162636465666768696a6b6c6d6e6f70717273 74
Jul 19 11:28:56 192.168.102.2 ZYXEL: Packet Trigger: Protocol=1, Data=4500002c1b0140001f06b50ec0a86614ca849a7b0427001700195b3e0000000600220008cd40000020405b4
Jul 19 11:29:06 192.168.102.2 ZYXEL: Packet Trigger: Protocol=1, Data=45000028240140001f06ac12c0a86614ca849a7b0427001700195b451d1430135004000077600000
3 - Filter Log
SdcmSyslogSend (SYSLOG FILLOG, SYSLOG NOTICE, String);
String = IP[Src=xx.xx.xx.xx Dst=xx.xx.xx.xx prot spo=xxxx dpo=xxxx] S04>R01mD
IP[...] is the packet header and S04>R01mD means filter set 4 (S) and rule 1 (R), match (m), drop (D).
Src: Source Address
Dst: Destination Address
prot: Protocol ("TCP", "UDP", "ICMP")
spo: Source port
dpo: Destination port
Jul 19 14:43:55 192.168.102.2 ZYXEL: IP [Src=202.132.154.123 Dst=255.255.255.255 UDP spo=0208 dpo=0208] S03>R01mF
Jul 19 14:44:00 192.168.102.2 ZYXEL: IP [Src=192.168.102.20 Dst=202.132.154.1 UDP spo=05d4 dpo=0035] S03>R01mF
Jul 19 14:44:04 192.168.102.2 ZYXEL: IP [Src=192.168.102.20 Dst=202.132.154.1 UDP spo=05d4 dpo=0035] S03>R01mF
4 - PPP Log
SdcmSyslogSend (SYSLOG PFPLOG, SYSLOG NOTICE, String);
String = ppp:Proto Starting / ppp:Proto Opening / ppp:Proto Closing / ppp:Proto Shutdown
Proto = LCP / ATCP / BACP / BCP / CBCP / CCF / CHAP / PAP / IPCP / IPXCP
Jul 19 11:42:44 192.168.102.2 ZYXEL: ppp:LCP Closing
Jul 19 11:42:49 192.168.102.2 ZYXEL: ppp:IPCP Closing
Jul 19 11:42:54 192.168.102.2 ZYXEL: ppp:CCP Closing

37.4 Diagnostic

The diagnostic facility allows you to test the different aspects of your Prestige to determine if it is working properly. Menu 24.4 allows you to choose among various types of diagnostic tests to evaluate your system, as shown in the following figure.

Follow the procedure next to get to Diagnostic:

Step 1. From the main menu, type 24 to open **Menu 24 – System Maintenance**.

Step 2. From this menu, type 4. Diagnostic to open **Menu 24.4 – System Maintenance – Diagnostic**.

```

Menu 24.4 - System Maintenance - Diagnostic

ADSL                               System
1.  Reset ADSL                      21. Reboot System
2.  Hang Up B1 Call                  22. Command Mode
3.  Hang Up B2 Call
4.  Reset ISDN
5.  ISDN Connection Test

Enter Menu Selection Number:
Host IP Address= N/A
    
```

Figure 37-9 Menu 24.4 System Maintenance : Diagnostic

The following table describes the diagnostic tests available in menu 24.4 for and the connections.

Table 37-4 Menu 24.4 System Maintenance Menu : Diagnostic

FIELD	DESCRIPTION
Reset ADSL	Re-initialize the ADSL link to the telephone company.
Hang Up B1-B2 Call	This tool hangs up the B1/B2 channel. It is only applicable if the channel is currently in use.
Reset ISDN	Re-initialize the ISDN link to the telephone company.
ISDN Connection Test	You can test to see if your ISDN line is working properly by using this option. This command triggers the Prestige to perform a loop-back test to check the functionality of the ISDN line. If the test is not successful, note the error message that you receive and consult your network administrator.
Ping Host	Ping the host to see if the links and TCP/IP protocol on both systems are working.
Reboot System	Reboot the Prestige.
Command Mode	Type the mode to test and diagnose your Prestige using specified commands.
Host IP Address	If you typed 12 to Ping Host, now type the address of the computer you want to ping.

Chapter 38

Firmware and Configuration File Maintenance

This chapter tells you how to backup and restore your configuration file as well as upload new firmware and configuration files.

38.1 Filename Conventions

The configuration file (often called the romfile or rom-0) contains the factory default settings in the menus such as password, DHCP Setup, TCP/IP Setup, etc. It arrives from ZyXEL with a “rom” filename extension. Once you have customized the Prestige's settings, they can be saved back to your computer under a filename of your choosing.

ZyNOS (ZyXEL Network Operating System sometimes referred to as the “ras” file) is the system firmware and has a “bin” filename extension. With many FTP and TFTP clients, the filenames are similar to those seen next.

Only use firmware for your Prestige's specific model. Refer to the label on the bottom of your Prestige.

```
ftp> put firmware.bin ras
```

This is a sample FTP session showing the transfer of the computer file " firmware.bin" to the Prestige.

```
ftp> get rom-0 config.cfg
```

This is a sample FTP session saving the current configuration to the computer file “config.cfg”.

If your (T)FTP client does not allow you to have a destination filename different than the source, you will need to rename them as the Prestige only recognizes “rom-0” and “ras”. Be sure you keep unaltered copies of both files for later use.

The following table is a summary. Please note that the internal filename refers to the filename on the Prestige and the external filename refers to the filename not on the Prestige, that is, on your computer, local network or FTP site and so the name (but not the extension) may vary. After uploading new firmware, see the **ZyNOS F/W Version** field in **Menu 24.2.1 – System Maintenance – Information** to confirm that you have uploaded the correct firmware version. The AT command is the command you enter after you press “y” when prompted in the SMT menu to go into debug mode.

Table 38-1 Filename Conventions

FILE TYPE	INTERNAL NAME	EXTERNAL NAME	DESCRIPTION
Configuration File	Rom-0	This is the configuration filename on the Prestige. Uploading the rom-0 file replaces the entire ROM file system, including your Prestige configurations, system-related data (including the default password), the error log and the trace log.	*.rom
Firmware	Ras	This is the generic name for the Zynos firmware on the Prestige.	*.bin

38.2 Backup Configuration

The Prestige displays different messages explaining different ways to backup, restore and upload files in menus 24.5, 24.6, 24.7.1 and 24.7.2; depending on whether you use the console port or Telnet.

Option 5 from **Menu 24 – System Maintenance** allows you to backup the current Prestige configuration to your computer. Backup is highly recommended once your Prestige is functioning properly. FTP is the preferred methods for backing up your current configuration to your computer since they are faster. You can also perform backup and restore using menu 24 through the console port. Any serial communications program should work fine; however, you must use Xmodem protocol to perform the download/upload and you don't have to rename the files.

Please note that terms “download” and “upload” are relative to the computer. Download means to transfer from the Prestige to the computer, while upload means from your computer to the Prestige.

38.2.1 Backup Configuration

Follow the instructions as shown in the next screen.

```
Menu 24.5 - System Maintenance - Backup Configuration

To transfer the configuration file to your workstation, follow the procedure
below:

1. Launch the FTP client on your workstation.
2. Type "open" and the IP address of your Prestige. Then type "root" and
   SMT password as requested.
3. Locate the 'rom-0' file.
4. Type 'get rom-0' to back up the current Prestige configuration to
   your workstation.

For details on FTP commands, please consult the documentation of your FTP
client program. For details on backup using TFTP (note that you must remain
in this menu to back up using TFTP), please see your Prestige manual.

Press ENTER to Exit:
```

Figure 38-1 Telnet in Menu 24.5

38.2.2 Using the FTP Command from the Command Line

- Step 1.** Launch the FTP client on your computer.
- Step 2.** Enter “open”, followed by a space and the IP address of your Prestige.
- Step 3.** Press [ENTER] when prompted for a username.
- Step 4.** Enter your password as requested (the default is “1234”).
- Step 5.** Enter “bin” to set transfer mode to binary.
- Step 6.** Use “get” to transfer files from the Prestige to the computer, for example, “get rom-0 config.rom” transfers the configuration file on the Prestige to your computer and renames it “config.rom”. See earlier in this chapter for more information on filename conventions.
- Step 7.** Enter “quit” to exit the ftp prompt.

38.2.3 Example of FTP Commands from the Command Line

```

331 Enter PASS command
Password:
230 Logged in
ftp> bin
200 Type I OK
ftp> get rom-0 zyxel.rom
200 Port command okay
150 Opening data connection for STOR ras
226 File received OK
ftp: 16384 bytes sent in 1.10Seconds 297.89Kbytes/sec.
ftp> quit
    
```

Figure 38-2 FTP Session Example

38.2.4 GUI-based FTP Clients

The following table describes some of the commands that you may see in GUI-based FTP clients.

Table 38-2 General Commands for GUI-based FTP Clients

COMMAND	DESCRIPTION
Host Address	Enter the address of the host server.
Login Type	Anonymous. This is when a user I.D. and password is automatically supplied to the server for anonymous access. Anonymous logins will work only if your ISP or service administrator has enabled this option. Normal. The server requires a unique User ID and Password to login.
Transfer Type	You must use binary mode when uploading the configuration or firmware file. Transfer files in either ASCII (plain text format) or in binary mode.
Initial Remote Directory	Specify the default remote directory (path).
Initial Local Directory	Specify the default local directory (path).

38.2.5 TFTP and FTP over WAN Will Not Work When

TFTP, FTP and Telnet over WAN will not work when:

1. You have disable Telnet service in menu 24.11.

2. You have applied a filter in menu 3.1 (LAN) or in menu 11.5 (WAN) to block Telnet service.
3. The IP address in the **Secured Client IP** field in menu 24.11 does not match the client IP. If it does not match, the Prestige will disconnect the Telnet session immediately.
4. You have an SMT console session running.

38.2.6 Backup Configuration Using TFTP

The Prestige supports the up/downloading of the firmware and the configuration file using TFTP (Trivial File Transfer Protocol) over LAN. Although TFTP should work over WAN as well, it is not recommended.

To use TFTP, your computer must have both telnet and TFTP clients. To backup the configuration file, follow the procedure shown next.

- Step 1.** Use telnet from your computer to connect to the Prestige and log in. Because TFTP does not have any security checks, the Prestige records the IP address of the telnet client and accepts TFTP requests only from this address.
- Step 2.** Put the SMT in command interpreter (CI) mode by entering 8 in **Menu 24 – System Maintenance**.
- Step 3.** Enter command “sys stdio 0” to disable the SMT timeout, so the TFTP transfer will not be interrupted. Enter command “sys stdio 5” to restore the five-minute SMT timeout (default) when the file transfer is complete.
- Step 4.** Launch the TFTP client on your computer and connect to the Prestige. Set the transfer mode to binary before starting data transfer.
- Step 5.** Use the TFTP client (see the example below) to transfer files between the Prestige and the computer. The file name for the configuration file is “rom-0” (rom-zero, not capital o).

Note that the telnet connection must be active and the SMT in CI mode before and during the TFTP transfer. For details on TFTP commands (see following example), please consult the documentation of your TFTP client program. For UNIX, use “get” to transfer from the Prestige to the computer and “binary” to set binary transfer mode.

38.2.7 TFTP Command Example

The following is an example TFTP command:

```
tftp [-i] host get rom-0 config.rom
```

where “i” specifies binary image transfer mode (use this mode when transferring binary files), “host” is the Prestige IP address, “get” transfers the file source on the Prestige (rom-0, name of the configuration file on the Prestige) to the file destination on the computer and renames it config.rom.

38.2.8 GUI-based TFTP Clients

The following table describes some of the fields that you may see in GUI-based TFTP clients.

Table 38-3 General Commands for GUI-based TFTP Clients

COMMAND	DESCRIPTION
Host	Enter the IP address of the Prestige. 192.168.1.1 is the Prestige's default IP address when shipped.
Send/Fetch	Use "Send" to upload the file to the Prestige and "Fetch" to back up the file on your computer.
Local File	Enter the path and name of the firmware file (*.bin extension) or configuration file (*.rom extension) on your computer.
Remote File	This is the filename on the Prestige. The filename for the firmware is "ras" and for the configuration file, is "rom-0".
Binary	Transfer the file in binary mode.
Abort	Stop transfer of the file.

Refer to *section 38.2.5* to read about configurations that disallow TFTP and FTP over WAN.

38.2.9 Backup Via Console Port

Back up configuration via console port by following the HyperTerminal procedure shown next. Procedures using other serial communications programs should be similar.

Step 1. Display menu 24.5 and enter "y" at the following screen.

```
Ready to backup Configuration via Xmodem.  
Do you want to continue (y/n):
```

Figure 38-3 Menu 24.5 System Maintenance : Backup Configuration

Step 2. The following screen indicates that the Xmodem download has started.

```
You can enter ctrl-x to terminate operation any time.  
Starting XMODEM download...
```

Figure 38-4 Menu 24.5 System Maintenance : Starting Xmodem Download Screen

Step 3. Run the HyperTerminal program by clicking **Transfer**, then **Receive File** as shown in the following screen.

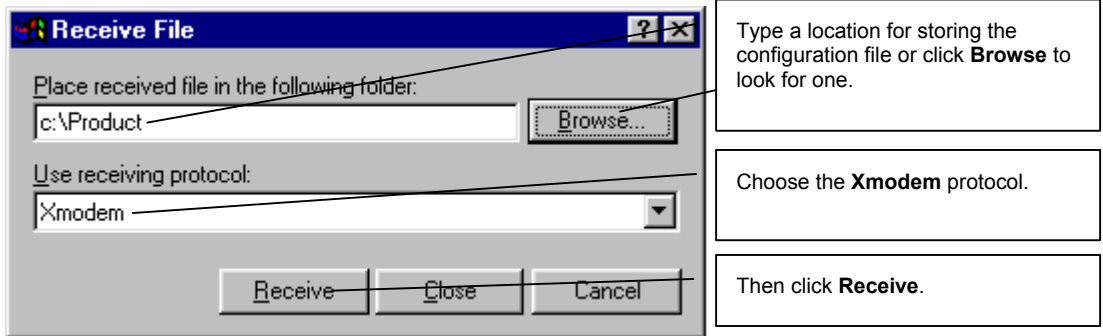

Figure 38-5 Backup Configuration Example

Step 4. After a successful backup you will see the following screen. Press any key to return to the SMT menu.

```

** Backup Configuration completed. OK.
### Hit any key to continue.###

```

Figure 38-6 Successful Backup Confirmation Screen

38.3 Restore Configuration

This section shows you how to restore a previously saved configuration. Note that this function erases the current configuration before restoring a previous back up configuration; please do not attempt to restore unless you have a backup configuration file stored on disk.

FTP is the preferred method for restoring your current computer configuration to your Prestige since FTP is faster. Please note that you must wait for the system to automatically restart after the file transfer is complete.

WARNING!
**DO NOT INTERRUPT THE FILE TRANSFER PROCESS AS THIS MAY
PERMANENTLY DAMAGE YOUR PRESTIGE.**

38.3.1 Restore Using FTP

For details about backup using (T)FTP please refer to earlier sections on FTP and TFTP file upload in this chapter.

```
Menu 24.6 -- System Maintenance - Restore Configuration

To transfer the firmware and configuration file to your workstation, follow the procedure
below:

1. Launch the FTP client on your workstation.
2. Type "open" and the IP address of your Prestige. Then type "root" and
   SMT password as requested.
3. Type "put backupfilename rom-0" where backupfilename is the name of
   your backup configuration file on your workstation and rom-0 is the
   remote file name on the Prestige. This restores the configuration to
   your Prestige.
4. The system reboots automatically after a successful file transfer

For details on FTP commands, please consult the documentation of your FTP
client program. For details on backup using TFTP (note that you must remain
in this menu to back up using TFTP), please see your Prestige manual.

Press ENTER to Exit:
```

Figure 38-7 Telnet into Menu 24.6

- Step 1.** Launch the FTP client on your computer.
- Step 2.** Enter “open”, followed by a space and the IP address of your Prestige.
- Step 3.** Press [ENTER] when prompted for a username.
- Step 4.** Enter your password as requested (the default is “1234”).
- Step 5.** Enter “bin” to set transfer mode to binary.
- Step 6.** Find the “rom” file (on your computer) that you want to restore to your Prestige.
- Step 7.** Use “put” to transfer files from the Prestige to the computer, for example, “put config.rom rom-0” transfers the configuration file “config.rom” on your computer to the Prestige. See earlier in this chapter for more information on filename conventions.
- Step 8.** Enter “quit” to exit the ftp prompt. The Prestige will automatically restart after a successful restore process.

38.3.2 Restore Using FTP Session Example

```
ftp> put config.rom rom-0
200 Port command okay
150 Opening data connection for STOR rom-0
226 File received OK
221 Goodbye for writing flash
ftp: 16384 bytes sent in 0.06Seconds 273.07Kbytes/sec.
ftp>quit
```

Figure 38-8 Restore Using FTP Session Example

Refer to *section 38.2.5* to read about configurations that disallow TFTP and FTP over WAN.

38.3.3 Restore Via Console Port

Restore configuration via console port by following the HyperTerminal procedure shown next. Procedures using other serial communications programs should be similar.

Step 1. Display menu 24.6 and enter “y” at the following screen.

```
Ready to restore Configuration via Xmodem.
Do you want to continue (y/n):
```

Figure 38-9 System Maintenance : Restore Configuration

Step 2. The following screen indicates that the Xmodem download has started.

```
Starting XMODEM download (CRC mode) ...
CCCCCCCC
```

Figure 38-10 System Maintenance : Starting Xmodem Download Screen

Step 3. Run the HyperTerminal program by clicking **Transfer**, then **Send File** as shown in the following screen.

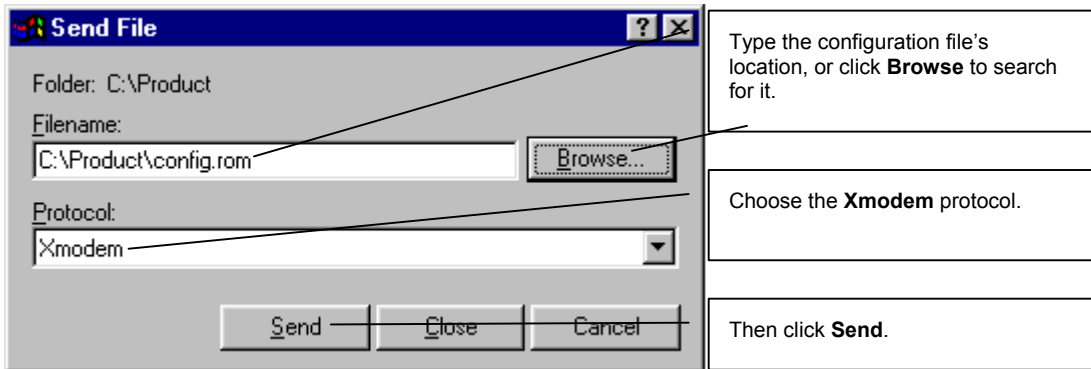

Figure 38-11 Restore Configuration Example

- Step 4.** After a successful restoration you will see the following screen. Press any key to restart the Prestige and return to the SMT menu.

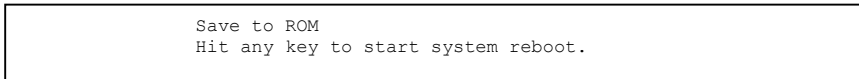

Figure 38-12 Successful Restoration Confirmation Screen

38.4 Uploading Firmware and Configuration Files

This section shows you how to upload firmware and configuration files. You can upload configuration files by following the procedure in the previous *Restore Configuration* section or by following the instructions in **Menu 24.7.2 – System Maintenance – Upload System Configuration File** (for console port).

WARNING!
DO NOT INTERRUPT THE FILE TRANSFER PROCESS AS THIS MAY PERMANENTLY DAMAGE YOUR PRESTIGE.

38.4.1 Firmware File Upload

FTP is the preferred method for uploading the firmware and configuration. To use this feature, your computer must have an FTP client.

When you telnet into the Prestige, you will see the following screens for uploading firmware and the configuration file using FTP.

```
Menu 24.7.1 - System Maintenance - Upload System Firmware

To upload the system firmware, follow the procedure below:

1. Launch the FTP client on your workstation.
2. Type "open" and the IP address of your system. Then type "root" and
   SMT password as requested.
3. Type "put firmware filename ras" where "firmwarefilename" is the name
   of your firmware upgrade file on your workstation and "ras" is the
   remote file name on the system.
4. The system reboots automatically after a successful firmware upload.

For details on FTP commands, please consult the documentation of your FTP
client program. For details on uploading system firmware using TFTP (note
that you must remain on this menu to upload system firmware using TFTP),
please see your manual.

Press ENTER to Exit:
```

Figure 38-13 Telnet Into Menu 24.7.1 Upload System Firmware

38.4.2 Configuration File Upload

You see the following screen when you telnet into menu 24.7.2.

```
Menu 24.7.2 - System Maintenance - Upload System Configuration File

To upload the system configuration file, follow the procedure below:

1. Launch the FTP client on your workstation.
2. Type "open" and the IP address of your system. Then type "root" and
   SMT password as requested.
3. Type "put configuration filename rom-0" where "configurationfilename"
   is the name of your system configuration file on your workstation, which
   will be transferred to the "rom-0" file on the system.
4. The system reboots automatically after the upload system configuration
   file process is complete.

For details on FTP commands, please consult the documentation of your FTP
client program. For details on uploading system firmware using TFTP (note
that you must remain on this menu to upload system firmware using TFTP),
please see your manual.

Press ENTER to Exit:
```

Figure 38-14 Telnet Into Menu 24.7.2 System Maintenance

To upload the firmware and the configuration file, follow these examples

38.4.3 FTP File Upload Command from the DOS Prompt Example

- Step 1.** Launch the FTP client on your computer.
- Step 2.** Enter “open”, followed by a space and the IP address of your Prestige.
- Step 3.** Press [ENTER] when prompted for a username.
- Step 4.** Enter your password as requested (the default is “1234”).
- Step 5.** Enter “bin” to set transfer mode to binary.
- Step 6.** Use “put” to transfer files from the computer to the Prestige, for example, “put firmware.bin ras” transfers the firmware on your computer (firmware.bin) to the Prestige and renames it “ras”. Similarly, “put config.rom rom-0” transfers the configuration file on your computer (config.rom) to the Prestige and renames it “rom-0”. Likewise “get rom-0 config.rom” transfers the configuration file on the Prestige to your computer and renames it “config.rom.” See earlier in this chapter for more information on filename conventions.
- Step 7.** Enter “quit” to exit the ftp prompt.

The Prestige automatically restarts after a successful file upload.

38.4.4 FTP Session Example of Firmware File Upload

```
331 Enter PASS command
Password:
230 Logged in
ftp> bin
200 Type I OK
ftp> put firmware.bin ras
200 Port command okay
150 Opening data connection for STOR ras
226 File received OK
ftp: 1103936 bytes sent in 1.10Seconds 297.89Kbytes/sec.
ftp> quit
```

Figure 38-15 FTP Session Example of Firmware File Upload

More commands (found in GUI-based FTP clients) are listed earlier in this chapter.

Refer to *section 38.2.5* to read about configurations that disallow TFTP and FTP over WAN.

38.4.5 TFTP File Upload

The Prestige also supports the uploading of firmware files using TFTP (Trivial File Transfer Protocol) over LAN. Although TFTP should work over WAN as well, it is not recommended.

To use TFTP, your computer must have both telnet and TFTP clients. To transfer the firmware and the configuration file, follow the procedure shown next.

- Step 1.** Use telnet from your computer to connect to the Prestige and log in. Because TFTP does not have any security checks, the Prestige records the IP address of the telnet client and accepts TFTP requests only from this address.
- Step 2.** Put the SMT in command interpreter (CI) mode by entering 8 in **Menu 24 – System Maintenance**.
- Step 3.** Enter the command “sys stdio 0” to disable the console timeout, so the TFTP transfer will not be interrupted. Enter “command sys stdio 5” to restore the five-minute console timeout (default) when the file transfer is complete.
- Step 4.** Launch the TFTP client on your computer and connect to the Prestige. Set the transfer mode to binary before starting data transfer.
- Step 5.** Use the TFTP client (see the example below) to transfer files between the Prestige and the computer. The file name for the firmware is “ras”.

Note that the telnet connection must be active and the Prestige in CI mode before and during the TFTP transfer. For details on TFTP commands (see following example), please consult the documentation of your TFTP client program. For UNIX, use “get” to transfer from the Prestige to the computer, “put” the other way around, and “binary” to set binary transfer mode.

38.4.6 TFTP Upload Command Example

The following is an example TFTP command:

```
tftp [-i] host put firmware.bin ras
```

where “i” specifies binary image transfer mode (use this mode when transferring binary files), “host” is the Prestige’s IP address and “put” transfers the file source on the computer (firmware.bin – name of the firmware on the computer) to the file destination on the remote host (ras - name of the firmware on the Prestige).

Commands that you may see in GUI-based TFTP clients are listed earlier in this chapter.

38.4.7 Uploading Via Console Port

FTP or TFTP are the preferred methods for uploading firmware to your Prestige. However, in the event of your network being down, uploading files is only possible with a direct connection to your Prestige via the console port. Uploading files via the console port under normal conditions is not recommended since FTP or TFTP is faster. Any serial communications program should work fine; however, you must use the Xmodem protocol to perform the download/upload.

38.4.8 Uploading Firmware File Via Console Port

Step 1. Select 1 from **Menu 24.7 – System Maintenance – Upload Firmware** to display **Menu 24.7.1 – System Maintenance – Upload System Firmware**, then follow the instructions as shown in the following screen.

```

Menu 24.7.1 - System Maintenance - Upload System Firmware

To upload system firmware:
1. Enter "y" at the prompt below to go into debug mode.
2. Enter "atur" after "Enter Debug Mode" message.
3. Wait for "Starting XMODEM upload" message before activating
   Xmodem upload on your terminal.
4. After successful firmware upload, enter "atgo" to restart the
   Prestige.

Warning: Proceeding with the upload will erase the current system
firmware.

Do You Wish To Proceed: (Y/N)
    
```

Figure 38-16 Menu 24.7.1 as seen using the Console Port

Step 2. After the "Starting Xmodem upload" message appears, activate the Xmodem protocol on your computer. Follow the procedure as shown previously for the HyperTerminal program. The procedure for other serial communications programs should be similar.

38.4.9 Example Xmodem Firmware Upload Using HyperTerminal

Click **Transfer**, then **Send File** to display the following screen.

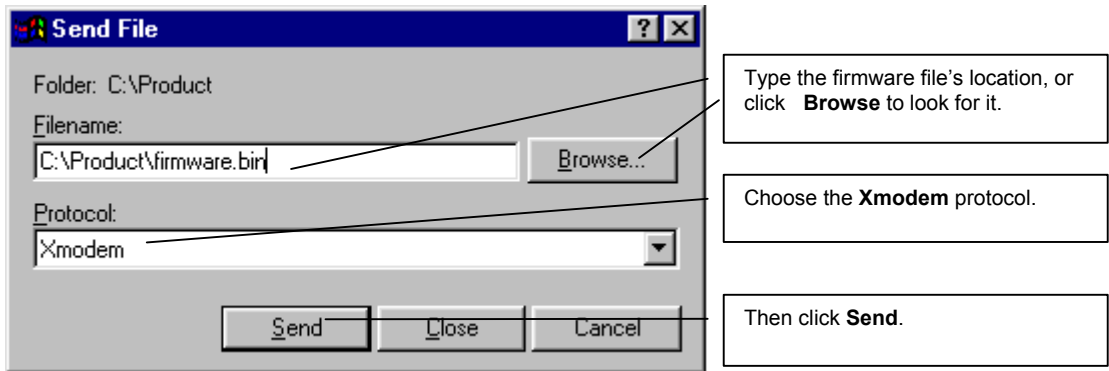

Figure 38-17 Example Xmodem Upload

After the configuration upload process has completed, restart the Prestige by entering "atgo".

38.4.10 Uploading Configuration File Via Console Port

- Step 1.** Select 2 from **Menu 24.7 – System Maintenance – Upload Firmware** to display **Menu 24.7.2 – System Maintenance – Upload System Configuration File**. Follow the instructions as shown in the next screen.

```
Menu 24.7.2 - System Maintenance - Upload System Configuration File

To upload system configuration file:
1. Enter "y" at the prompt below to go into debug mode.
2. Enter "atlc" after "Enter Debug Mode" message.
3. Wait for "Starting XMODEM upload" message before activating
   Xmodem upload on your terminal.
4. After successful firmware upload, enter "atgo" to restart the
   system.

Warning:
1. Proceeding with the upload will erase the current
   configuration file.
2. The system's console port speed (Menu 24.2.2) may change
   when it is restarted; please adjust your terminal's speed
   accordingly. The password may change (menu 23), also.
3. When uploading the DEFAULT configuration file, the console
   port speed will be reset to 9600 bps and the password to
   "1234".

Do You Wish To Proceed: (Y/N)
```

Figure 38-18 Menu 24.7.2 as seen using the Console Port

- Step 2.** After the "Starting Xmodem upload" message appears, activate the Xmodem protocol on your computer. Follow the procedure as shown previously for the HyperTerminal program. The procedure for other serial communications programs should be similar.

- Step 3.** Enter "atgo" to restart the Prestige.

38.4.11 Example Xmodem Configuration Upload Using HyperTerminal

Click **Transfer**, then **Send File** to display the following screen.

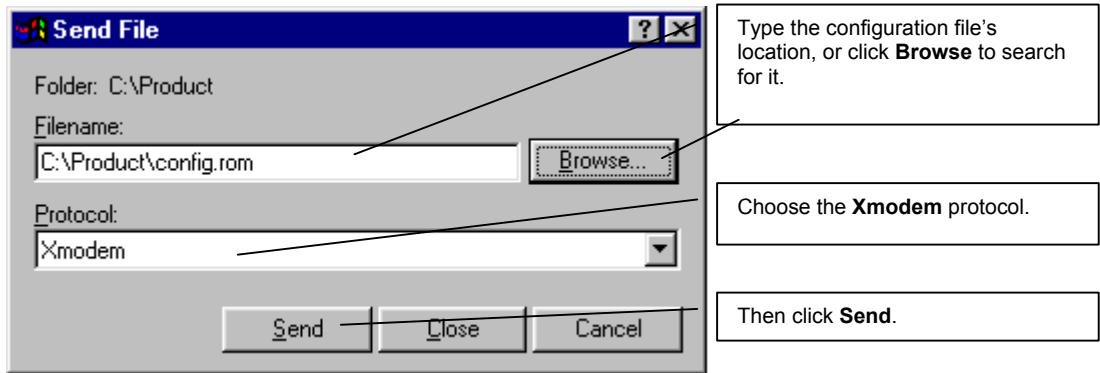

Figure 38-19 Example Xmodem Upload

After the configuration upload process has completed, restart the Prestige by entering "atgo".

Chapter 39

System Maintenance

This chapter leads you through SMT menus 24.8 to 24.10.

39.1 Command Interpreter Mode

The Command Interpreter (CI) is a part of the main system firmware. The CI provides much of the same functionality as the SMT, while adding some low-level setup and diagnostic functions. Enter the CI from the SMT by selecting menu 24.8. See the included disk or the zyxel.com web site for more detailed information on CI commands. Enter 8 from **Menu 24 — System Maintenance**. A list of valid commands can be found by typing `help` or `?` at the command prompt. Type “exit” to return to the SMT main menu when finished.

```
Menu 24 - System Maintenance

1. System Status
2. System Information
3. Log and Trace
4. Diagnostic
5. Backup Configuration
6. Restore Configuration
7. Firmware Update
8. Command Interpreter Mode
9. Call Control
10. Time and Date Setting
11. Remote Management

Enter Menu Selection Number:
```

Figure 39-1 Command Mode in Menu 24

```
Copyright (c) 1994 - 2003 ZyXEL Communications Corp.
653HWI> ?
Valid commands are:
sys          exit          device        ether
wan          poe           wlan          isdn
ip           ipsec         ppp          bridge
hdap        dcp           radius       8021x
```

Figure 39-2 Valid Commands

39.2 Call Control Support

Call Control Support is only applicable when **Encapsulation** is set to **PPPoE** in menu 4 or menu 11.1.

The budget management function allows you to set a limit on the total outgoing call time of the Prestige within certain times. When the total outgoing call time exceeds the limit, the current call will be dropped and any future outgoing calls will be blocked.

To access the call control menu, select option 9 in menu 24 to go to **Menu 24.9 — System Maintenance — Call Control**, as shown in the next table.

```
Menu 24.9 - System Maintenance - Call Control
```

```
1. Budget Management
```

```
Enter Menu Selection Number:
```

Figure 39-3 Menu 24.9 System Maintenance : Call Control

39.2.1 Budget Management

Menu 24.9.1 shows the budget management statistics for outgoing calls. Enter 1 from **Menu 24.9 — System Maintenance — Call Control** to bring up the following menu.

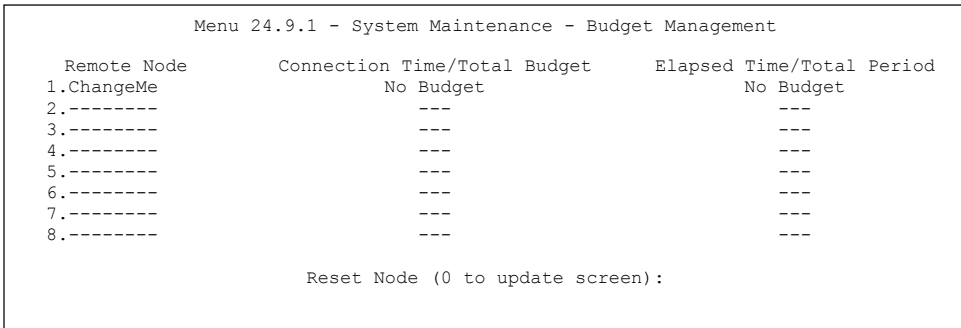

Figure 39-4 Menu 24.9.1 System Maintenance : Budget Management

The total budget is the time limit on the accumulated time for outgoing calls to a remote node. When this limit is reached, the call will be dropped and further outgoing calls to that remote node will be blocked. After each period, the total budget is reset. The default for the total budget is 0 minutes and the period is 0 hours, meaning no budget control. You can reset the accumulated connection time in this menu by entering the index of a remote node. Enter 0 to update the screen. The budget and the reset period can be configured in menu 11.1 for the remote node when PPPoE encapsulation is selected.

Table 39-1 Menu 24.9.1 System Maintenance : Budget Management

FIELD	DESCRIPTION	EXAMPLE
Remote Node	Enter the index number of the remote node you want to reset (just one in this case)	1
Connection Time/Total Budget	This is the total connection time that has gone by (within the allocated budget that you set in menu 11.1.	5/10 means that 5 minutes out of a total allocation of 10 minutes have lapsed.
Elapsed Time/Total Period	The period is the time cycle in hours that the allocation budget is reset (see menu 11.1.) The elapsed time is the time used up within this period.	0.5/1 means that 30 minutes out of the 1 hour time period has lapsed.
Enter "0" to update the screen or press [ESC] to return to the previous screen.		

39.3 Time and Date Setting

The Prestige keeps track of the time and date. There is also a software mechanism to set the time manually or get the current time and date from an external server when you turn on your Prestige. Menu 24.10 allows you to update the time and date settings of your Prestige. The real time is then displayed in the Prestige error logs and firewall logs.

Select menu 24 in the main menu to open **Menu 24 System Maintenance**, as shown next.

```
Menu 24 - System Maintenance

1. System Status
2. System Information
3. Log and Trace
4. Diagnostic
5. Backup Configuration
6. Restore Configuration
7. Upload Firmware
8. Command Interpreter Mode
9. Call Control
10. Time and Date Setting
11. Remote Management

Enter Menu Selection Number:
```

Figure 39-5 Menu 24 System Maintenance

Then enter 10 to go to **Menu 24.10 System Maintenance Time and Date Setting** to update the time and date settings of your Prestige as shown in the following screen.

```
Menu 24.10 - System Maintenance - Time and Date Setting

Use Time Server when Bootup= None
Time Server Address= N/A

Current Time:                00 : 00 : 00
New Time (hh:mm:ss):        11 : 23 : 16

Current Date:                2000 - 01 - 01
New Date (yyyy-mm-dd):      2001 - 03 - 01

Time Zone= GMT

Daylight Saving= No
Start Date (mm-dd):          01 - 00
End Date (mm_dd):            01 - 00

Press ENTER to Confirm or ESC to Cancel:
```

Figure 39-6 Menu 24.10 System Maintenance: Time and Date Setting

Table 39-2 Menu 24.10 System Maintenance: Time and Date Setting

FIELD	DESCRIPTION
Use Time Server when Bootup	<p>Enter the time service protocol that your time server sends when you turn on the Prestige. Not all time servers support all protocols, so you may have to check with your ISP/network administrator or use trial and error to find a protocol that works. The main differences between them are the format.</p> <p>Daytime (RFC 867) format is day/month/year/time zone of the server.</p> <p>Time (RFC-868) format displays a 4-byte integer giving the total number of seconds since 1970/1/1 at 0:0:0.</p> <p>NTP (RFC-1305) is similar to Time (RFC-868).</p> <p>None. The default, enter the time manually.</p>
Time Server Address	Enter the IP address or domain name of your time server. Check with your ISP/network administrator if you are unsure of this information.
Current Time New Time	<p>This field displays an updated time only when you reenter this menu.</p> <p>Enter the new time in hour, minute and second format.</p>
Current Date New Date	<p>This field displays an updated date only when you re-enter this menu.</p> <p>Enter the new date in year, month and day format.</p>
Time Zone	Press [SPACE BAR] and then [ENTER] to set the time difference between your time zone and Greenwich Mean Time (GMT).
Daylight Saving Start Date End Date	<p>If you use daylight savings time, then choose Yes.</p> <p>If using daylight savings time, enter the month and day that it starts on.</p> <p>If using daylight savings time, enter the month and day that it ends on</p>
Once you have filled in this menu, press [ENTER] at the message "Press ENTER to Confirm or ESC to Cancel" to save your configuration, or press [ESC] to cancel.	

39.3.1 Resetting the Time

The Prestige resets the time in three instances:

- i. On leaving menu 24.10 after making changes.
- ii. When the Prestige starts up, if there is a timeserver configured in menu 24.10.
- iii. 24-hour intervals after starting.

Chapter 40

Remote Management

This chapter covers remote management (SMT menu 24.11).

40.1 Remote Management Overview

Remote management allows you to determine which services/protocols can access which Prestige interface (if any) from which computers.

When you configure remote management to allow management from the WAN, you still need to configure a firewall rule to allow access. See the firewall chapters for details on configuring firewall rules.

40.2 Remote Management

To disable remote management of a service, select **Disable** in the corresponding **Server Access** field.

Enter 11 from menu 24 to display **Menu 24.11 — Remote Management Control**.

40.2.1 Remote Management Setup

You may manage your Prestige from a remote location via:

the Internet (**WAN only**), the **LAN only**, **All** (LAN and WAN) or **Disable** (neither).

- WAN only (Internet)
- ALL (LAN and WAN)
- LAN only
- Disable (Neither)

If you enable remote management of a service, but have applied a filter to block the service, then you will not be able to remotely manage the service.

Enter 11, from menu 24, to display **Menu 24.11 — Remote Management Control** (shown next).

```

Menu 24.11 - Remote Management Control

TELNET Server:
  Server Port = 23                Server Access = LAN only
  Secured Client IP = 0.0.0.0

FTP Server:
  Server Port = 21                Server Access = LAN only
  Secured Client IP = 0.0.0.0

Web Server:
  Server Port = 80                Server Access = LAN only
  Secured Client IP = 0.0.0.0

Press ENTER to Confirm or ESC to Cancel:
    
```

Figure 40-1 Menu 24.11 Remote Management Control

The following table describes the fields in this menu.

Table 40-1 Menu 24.11 Remote Management Control

FIELD	DESCRIPTION	EXAMPLE
Telnet Server FTP Server Web Server	Each of these read-only labels denotes a service that you may use to remotely manage the Prestige.	
Port	This field shows the port number for the remote management service. You may change the port number for a service if needed, but you must use the same port number to use that service for remote management.	23
Access	Select the access interface (if any) by pressing the [SPACE BAR]. Choices are: LAN only , WAN only , All or Disable . The default is LAN only .	LAN only
Secured Client IP	The default 0.0.0.0 allows any client to use this service to remotely manage the Prestige. Enter an IP address to restrict access to a client with a matching IP address.	0.0.0.0
Once you have filled in this menu, press [ENTER] at the message "Press ENTER to Confirm or ESC to Cancel" to save your configuration, or press [ESC] to cancel.		

40.2.2 Remote Management Limitations

Remote management over LAN or WAN will not work when:

1. A filter in menu 3.1 (LAN) or in menu 11.5 (WAN) is applied to block a Telnet, FTP or Web service.
2. You have disabled that service in menu 24.11.
3. The IP address in the **Secured Client IP** field (menu 24.11) does not match the client IP address. If it does not match, the Prestige will disconnect the session immediately.
4. There is already another remote management session of the same type (Telnet, FTP or Web) running. You may only have one remote management session of the same type running at one time.
5. There is a web remote management session running with a Telnet session. A Telnet session will be disconnected if you begin a web session; it will not begin if there already is a web session.

40.3 Remote Management and NAT

When NAT is enabled:

- Use the Prestige's WAN IP address when configuring from the WAN.
- Use the Prestige's LAN IP address when configuring from the LAN.

40.4 System Timeout

There is a system timeout of five minutes (300 seconds) for Telnet/web/FTP connections. Your Prestige will automatically log you out if you do nothing in this timeout period, except when it is continuously updating the status in menu 24.1 or when `sys stdio` has been changed on the command line.

Chapter 41

IP Policy Routing

This chapter covers setting and applying policies used for IP routing.

41.1 IP Policy Routing Overview

Traditionally, routing is based on the destination address only and the IAD takes the shortest path to forward a packet. IP Routing Policy (IPPR) provides a mechanism to override the default routing behavior and alter the packet forwarding based on the policy defined by the network administrator. Policy-based routing is applied to incoming packets on a per interface basis, prior to the normal routing.

41.2 Benefits of IP Policy Routing

- Source-Based Routing – Network administrators can use policy-based routing to direct traffic from different users through different connections.
- Quality of Service (QoS) – Organizations can differentiate traffic by setting the precedence or TOS (Type of Service) values in the IP header at the periphery of the network to enable the backbone to prioritize traffic.
- Cost Savings – IPPR allows organizations to distribute interactive traffic on high-bandwidth, high-cost paths while using low-cost paths for batch traffic.
- Load Sharing – Network administrators can use IPPR to distribute traffic among multiple paths.

41.3 Routing Policy

Individual routing policies are used as part of the overall IPPR process. A policy defines the matching criteria and the action to take when a packet meets the criteria. The action is taken only when all the criteria are met. The criteria includes the source address and port, IP protocol (ICMP, UDP, TCP, etc.), destination address and port, TOS and precedence (fields in the IP header) and length. The inclusion of length criterion is to differentiate between interactive and bulk traffic. Interactive applications, for example, telnet, tend to have short packets, while bulk traffic, for example, file transfer, tends to have large packets.

The actions that can be taken include:

- routing the packet to a different gateway (and hence the outgoing interface).
- setting the TOS and precedence fields in the IP header.

IPPR follows the existing packet filtering facility of RAS in style and in implementation. The policies are divided into sets, where related policies are grouped together. A user defines the policies before applying them to an interface or a remote node, in the same fashion as the filters. There are 12 policy sets with six policies in each set.

41.4 IP Routing Policy Setup

Menu 25 shows all the policies defined.

Menu 25 - IP Routing Policy Setup			
Policy Set #	Name	Policy Set #	Name
1	test	7	_____
2	_____	8	_____
3	_____	9	_____
4	_____	10	_____
5	_____	11	_____
6	_____	12	_____

Enter Policy Set Number to Configure= 0

Edit Name= N/A

Press ENTER to Confirm or ESC to Cancel:

Figure 41-1 Menu 25 IP Routing Policy Setup

To setup a routing policy, perform the following procedures:

- Step 1.** Type 25 in the main menu to open **Menu 25 – IP Routing Policy Setup**.
- Step 2.** Type the index of the policy set you want to configure to open **Menu 25.1 – IP Routing Policy Setup**.

Menu 25.1 shows the summary of a policy set, including the criteria and the action of a single policy, and whether a policy is active or not. Each policy contains two lines. The former part is the criteria of the incoming packet and the latter is the action. Between these two parts, separator “|” means the action is taken on criteria matched and separator “=” means the action is taken on criteria not matched.

```

Menu 25.1 - IP Routing Policy Setup

# A Criteria/Action
- - -----
1 Y SA=1.1.1.1-1.1.1.1,DA=2.2.2.2-2.2.2.5
   SP=20-25,DP=20-25,P=6,T=NM,PR=0 |GW=192.168.1.1,T=MT,PR=0
2 N _____
3 N _____
4 N _____
5 N _____
6 N _____

Enter Policy Rule Number (1-6) to Configure:

```

Figure 41-2 Menu 25.1 IP Routing Policy Setup

Table 41-1 Menu 25.1 IP Routing Policy Setup

ABBREVIATION		MEANING
Criteria	SA	Source IP Address
	SP	Source Port
	DA	Destination IP Address
	DP	Destination Port
	P	IP layer 4 protocol number (TCP=6, UDP=17...)
	T	Type of service of incoming packet
	PR	Precedence of incoming packet
	Action	GW
T		Outgoing Type of service
P		Outgoing Precedence
Service	NM	Normal
	MD	Minimum Delay
	MT	Maximum Throughput
	MR	Maximum Reliability
	MC	Minimum Cost

Type a number from 1 to 6 to display **Menu 25.1.1 – IP Routing Policy** (see the next figure). This menu allows you to configure a policy rule.

```

Menu 25.1.1 - IP Routing Policy

Policy Set Name= test
Active= Yes
Criteria:
  IP Protocol      = 6
  Type of Service= Normal          Packet length= 40
  Precedence      = 0              Len Comp= N/A
Source:
  addr start= 1.1.1.1             end= 1.1.1.1
  port start= 20                  end= 20
Destination:
  addr start= 2.2.2.2             end= 2.2.2.2
  port start= 20                  end= 20
Action= Matched
Gateway addr      = 192.168.1.1   Log= No
Type of Service= Max Thruput
Precedence       = 0

Press ENTER to Confirm or ESC to Cancel:

Press Space Bar to Toggle.
    
```

Figure 41-3 Menu 25.1.1 IP Routing Policy

The following table describes the fields in this menu.

Table 41-2 Menu 25.1.1 IP Routing Policy

FIELD	DESCRIPTION
Policy Set Name	This is the policy set name assigned in Menu 25 – IP Routing Policy Setup .
Active	Press [SPACE BAR] and then [ENTER] to select Yes to activate or No to deactivate the policy. Inactive policies are displayed with a minus sign “-“ in SMT menu 25.
Criteria	
IP Protocol	IP layer 4 protocol, for example, UDP, TCP, ICMP , etc.
Type of Service	Prioritize incoming network traffic by choosing from Don't Care, Normal, Min Delay, Max Thruput, Min Cost or Max Reliable .
Precedence	Precedence value of the incoming packet. Press [SPACE BAR] and then [ENTER] to select a value from 0 to 7 or Don't Care .
Packet Length	Type the length of incoming packets (in bytes). The operators in the Len Comp (next field) apply to packets of this length.

Table 41-2 Menu 25.1.1 IP Routing Policy

FIELD	DESCRIPTION
Len Comp	Press [SPACE BAR] and then [ENTER] to choose from Equal , Not Equal , Less , Greater , Less or Equal or Greater or Equal .
Source:	
addr start / end	Source IP address range from start to end.
port start / end	Source port number range from start to end; applicable only for TCP/UDP.
Destination:	
addr start / end	Destination IP address range from start to end.
port start / end	Destination port number range from start to end; applicable only for TCP/UDP.
Action	Specifies whether action should be taken on criteria Matched or Not Matched .
Gateway addr	Defines the outgoing gateway address. The gateway must be on the same subnet as the Prestige if it is on the LAN, otherwise, the gateway must be the IP address of a remote node. The default gateway is specified as 0.0.0.0.
Type of Service	Set the new TOS value of the outgoing packet. Prioritize incoming network traffic by choosing No Change , Normal , Min Delay , Max Thruput , Max Reliable or Min Cost .
Precedence	Set the new outgoing packet precedence value. Values are 0 to 7 or No Change .
Log	Press [SPACE BAR] and then [ENTER] to select Yes to make an entry in the system log when a policy is executed.
When you have completed this menu, press [ENTER] at the prompt "Press ENTER to confirm or ESC to cancel" to save your configuration or press [ESC] to cancel and go back to the previous screen.	

41.5 Applying an IP Policy

This section shows you where to apply the IP policies after you design them.

41.5.1 Ethernet IP Policies

From **Menu 3 — Ethernet Setup**, type 2 to go to **Menu 3.2 — TCP/IP and DHCP Ethernet Setup**.

You can choose up to four IP policy sets (from 12) by typing their numbers separated by commas, for example, 2, 4, 7, 9.

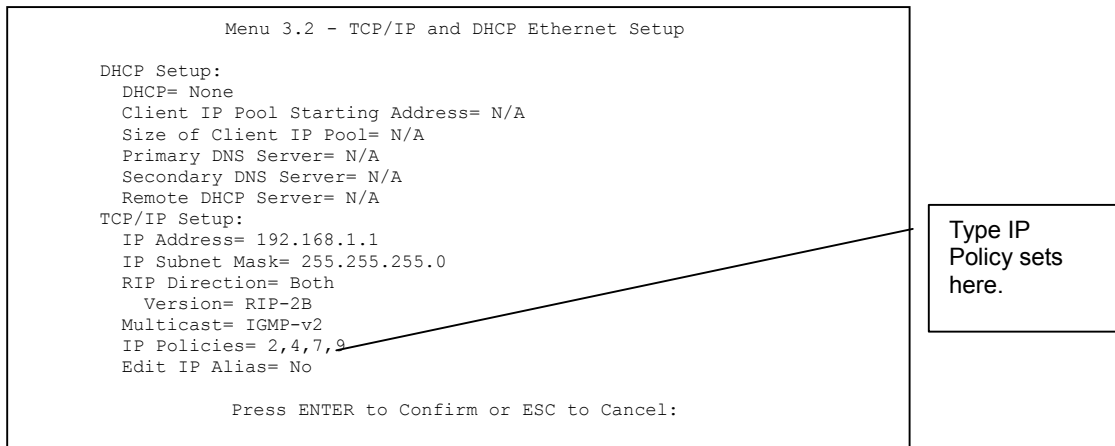

Figure 41-4 Menu 3.2 TCP/IP and DHCP Ethernet Setup

Go to menu 11.3 (shown next) and type the number(s) of the IP Routing Policy set(s) as appropriate. You can cascade up to four policy sets by typing their numbers separated by commas.

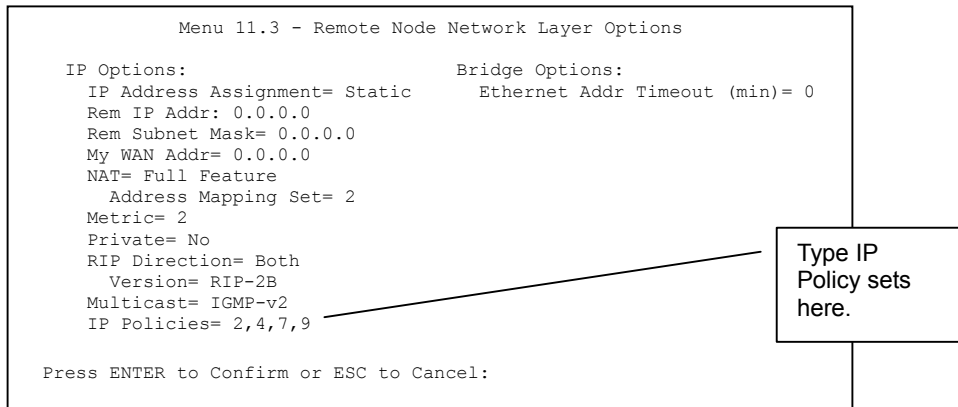

Figure 41-5 Menu 11.3 Remote Node Network Layer Options

41.6 IP Policy Routing Example

If a network has both Internet and remote node connections, you can route Web packets to the Internet using one policy and route FTP packets to a remote network using another policy. See the next figure.

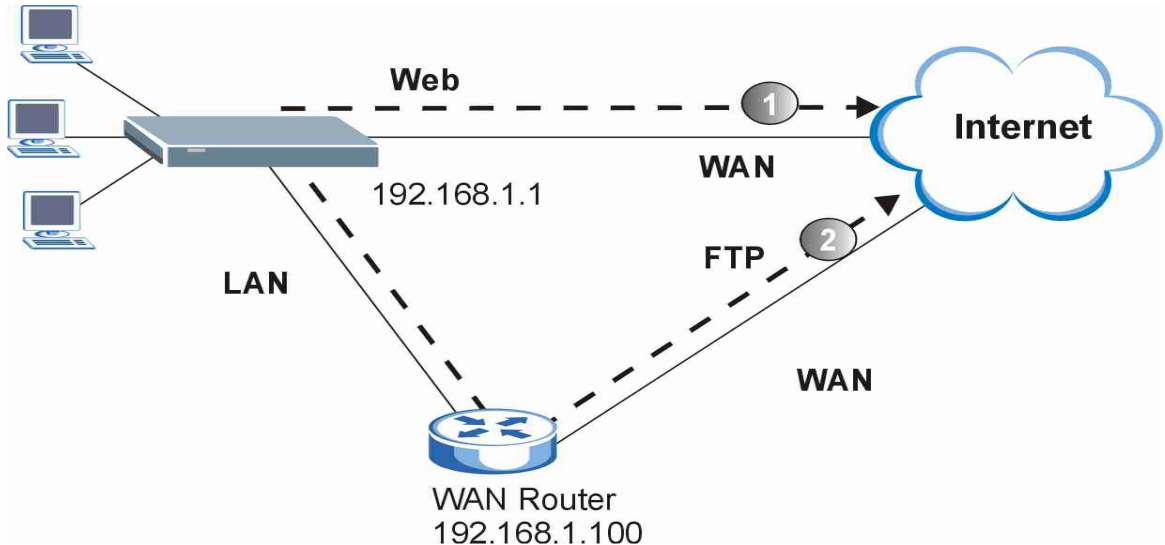

Figure 41-6 Example of IP Policy Routing

To force Web packets coming from clients with IP addresses of 192.168.1.33 to 192.168.1.64 to be routed to the Internet via the WAN port of the Prestige, follow the steps as shown next.

- Step 1.** Create a routing policy set in menu 25.
- Step 2.** Create a rule for this set in **Menu 25.1.1 — IP Routing Policy** as shown next.

```
Menu 25.1.1 - IP Routing Policy

Policy Set Name= set1
Active= Yes
Criteria:
  IP Protocol      = 6
  Type of Service= Don't Care      Packet length= 10
  Precedence      = Don't Care      Len Comp= N/A
Source:
  addr start= 192.168.1.2          end= 192.168.1.64
  port start= 0                    end= N/A
Destination:
  addr start= 0.0.0.0              end= N/A
  port start= 80                   end= 80
Action= Matched
Gateway addr      = 192.168.1.1    Log= No
Type of Service= No Change
Precedence       = No Change

Press ENTER to Confirm or ESC to Cancel:
Press Space Bar to Toggle.
```

Figure 41-7 IP Routing Policy Example

- Step 3.** Check **Menu 25.1 — IP Routing Policy Setup** to see if the rule is added correctly.
- Step 4.** Create another policy set in menu 25.
- Step 5.** Create a rule in menu 25.1 for this set to route packets from any host (IP=0.0.0.0 means any host) with protocol TCP and port FTP access through another gateway (192.168.1.100).

```

Menu 25.1.1 - IP Routing Policy

Policy Set Name= set2
Active= Yes
Criteria:
  IP Protocol      = 6
  Type of Service= Don't Care           Packet length= 10
  Precedence      = Don't Care           Len Comp= N/A
Source:
  addr start= 0.0.0.0                   end= N/A
  port start= 0                          end= N/A
Destination:
  addr start= 0.0.0.0                   end= N/A
  port start= 20                         end= 21
Action= Matched
Gateway addr =192.168.1.100           Log= No
Type of Service= No Change
Precedence      = No Change

Press ENTER to Confirm or ESC to Cancel:
Press Space Bar to Toggle.

```

Figure 41-8 IP Routing Policy Example

Step 6. Check **Menu 25.1 — IP Routing Policy Setup** to see if the rule is added correctly.

Step 7. Apply both policy sets in menu 3.2 as shown next.

```

Menu 3.2 - TCP/IP and DHCP Ethernet Setup

DHCP Setup
  DHCP= Server
  Client IP Pool Starting Address= 192.168.1.33
  Size of Client IP Pool= 64
  Primary DNS Server= 0.0.0.0
  Secondary DNS Server= 0.0.0.0
  Remote DHCP Server= N/A
TCP/IP Setup:
  IP Address= 192.168.1.1
  IP Subnet Mask= 255.255.255.0
  RIP Direction= Both
  Version= RIP-1
  Multicast= None
IP Policies= 1,2
  Edit IP Alias= No

Press ENTER to Confirm or ESC to Cancel:

Press Space Bar to Toggle.

```

Figure 41-9 Applying IP Policies Example

Chapter 42

Call Scheduling

Call scheduling (applicable for PPPoA or PPPoE encapsulation only) allows you to dictate when a remote node should be called and for how long.

42.1 Introduction

The call scheduling feature allows the Prestige to manage a remote node and dictate when a remote node should be called and for how long. This feature is similar to the scheduler in a videocassette recorder (you can specify a time period for the VCR to record). You can apply up to 4 schedule sets in **Menu 11.1 — Remote Node Profile**. From the main menu, enter 26 to access **Menu 26 — Schedule Setup** as shown next.

Menu 26 - Schedule Setup			
Schedule Set #	Name	Schedule Set #	Name
1	_____	7	_____
2	_____	8	_____
3	_____	9	_____
4	_____	10	_____
5	_____	11	_____
6	_____	12	_____

Enter Schedule Set Number to Configure=
 Edit Name=
 Press ENTER to Confirm or ESC to Cancel:

Figure 42-1 Menu 26 Schedule Setup

Lower numbered sets take precedence over higher numbered sets thereby avoiding scheduling conflicts. For example, if sets 1, 2, 3 and 4 in are applied in the remote node then set 1 will take precedence over set 2, 3 and 4 as the Prestige, by default, applies the lowest numbered set first. Set 2 will take precedence over set 3 and 4, and so on.

You can design up to 12 schedule sets but you can only apply up to four schedule sets for a remote node.

To delete a schedule set, enter the set number and press [SPACE BAR] and then [ENTER] (or delete) in the Edit Name field.

To setup a schedule set, select the schedule set you want to setup from menu 26 (1-12) and press [ENTER] to see **Menu 26.1 — Schedule Set Setup** as shown next.

```

Menu 26.1 - Schedule Set Setup

Active= Yes
Start Date(yyyy/mm/dd) = 2000 - 01 - 01
How Often= Once
Once:
  Date(yyyy/mm/dd)= 2000 - 01 - 01
Weekdays:
  Sunday= N/A
  Monday= N/A
  Tuesday= N/A
  Wednesday= N/A
  Thursday= N/A
  Friday= N/A
  Saturday= N/A
Start Time (hh:mm)= 00 : 00
Duration (hh:mm)= 00 : 00
Action= Forced On

      Press ENTER to Confirm or ESC to Cancel:
Press Space Bar to Toggle
    
```

Figure 42-2 Menu 26.1 Schedule Set Setup

If a connection has been already established, your Prestige will not drop it. Once the connection is dropped manually or it times out, then that remote node can't be triggered up until the end of the **Duration**.

Table 42-1 Menu 26.1 Schedule Set Setup

FIELD	DESCRIPTION	EXAMPLE
Active	Press [SPACE BAR] to select Yes or No . Choose Yes and press [ENTER] to activate the schedule set.	Yes
Start Date	Enter the start date when you wish the set to take effect in year -month-date format. Valid dates are from the present to 2036-February-5.	2000-01-01

Table 42-1 Menu 26.1 Schedule Set Setup

FIELD	DESCRIPTION	EXAMPLE
How Often	Should this schedule set recur weekly or be used just once only? Press the [SPACE BAR] and then [ENTER] to select Once or Weekly . Both these options are mutually exclusive. If Once is selected, then all weekday settings are N/A . When Once is selected, the schedule rule deletes automatically after the scheduled time elapses.	Once
Once: Date	If you selected Once in the How Often field above, then enter the date the set should activate here in year-month-date format.	2000-01-01
Weekday : Day	If you selected Weekly in the How Often field above, then select the day(s) when the set should activate (and recur) by going to that day(s) and pressing [SPACE BAR] to select Yes , then press [ENTER].	Yes No N/A
Start Time	Enter the start time when you wish the schedule set to take effect in hour-minute format.	09:00
Duration	Enter the maximum length of time this connection is allowed in hour-minute format.	08:00
Action	Forced On means that the connection is maintained whether or not there is a demand call on the line and will persist for the time period specified in the Duration field. Forced Down means that the connection is blocked whether or not there is a demand call on the line. Enable Dial-On-Demand means that this schedule permits a demand call on the line. Disable Dial-On-Demand means that this schedule prevents a demand call on the line.	Forced On
When you have completed this menu, press [ENTER] at the prompt "Press ENTER to confirm or ESC to cancel" to save your configuration or press [ESC] to cancel and go back to the previous screen.		

Once your schedule sets are configured, you must then apply them to the desired remote node(s). Enter 11 from the **Main Menu** and then enter the target remote node index. Using [SPACE BAR], select **PPPoE** or **PPPoA** in the **Encapsulation** field and then press [ENTER] to make the schedule sets field available as shown next.

```
Menu 11.1 - Remote Node Profile

Rem Node Name= ChangeMe          Route= IP
Active= Yes                       Bridge= No

Encapsulation= PPPoE             Edit IP/Bridge= No
Multiplexing=VC-based            Edit ATM Options= No
Service Name=                    Telco Option:
Incoming                          Allocated Budget(min)= 0
  Rem Login=                      Period(hr)= 0
  Rem Password= *****          Schedules= 1,2,3,4
Outgoing                          Nailed-Up Connection= No
  My Login=?
  My Password= *****
  Authen= CHAP/PAP

Session Options:
  Edit Filter Sets= No
  Idle Timeout(sec)= 100

Press ENTER to Confirm or ESC to Cancel:

Press Space Bar to Toggle.
```

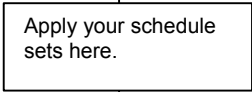

Figure 42-3 Applying Schedule Set(s) to a Remote Node (PPPoE)

You can apply up to four schedule sets, separated by commas, for one remote node. Change the schedule set numbers to your preference(s).

Part XI:

SMT VPN/IPSec and Internal SPTGEN

This part provides information about configuring VPN/IPSec for secure communications and Internal SPTGEN for configuration of multiple Prestiges.

See the web configurator parts of this guide for background information on features configurable by web configurator and SMT.

Chapter 43

VPN/IPSec Setup

This chapter introduces the VPN SMT menus.

43.1 VPN/IPSec Overview

The VPN/IPSec main SMT menu has these main submenus:

1. Define VPN policies in menu 27.1 submenus, including security policies, endpoint IP addresses, peer IPSec router IP address and key management.
2. **Menu 27.2 - SA Monitor** allows you to manage (refresh or disconnect) your SA connections.

This is an overview of the VPN menu tree.

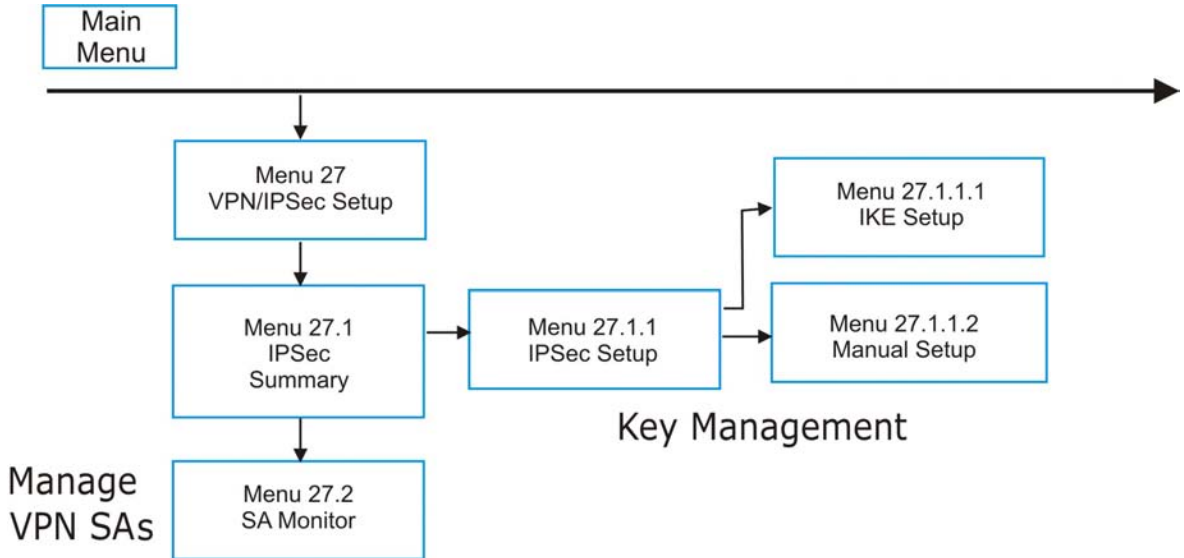

Figure 43-1 VPN SMT Menu Tree

From the main menu, enter 27 to display the first VPN menu (shown next).

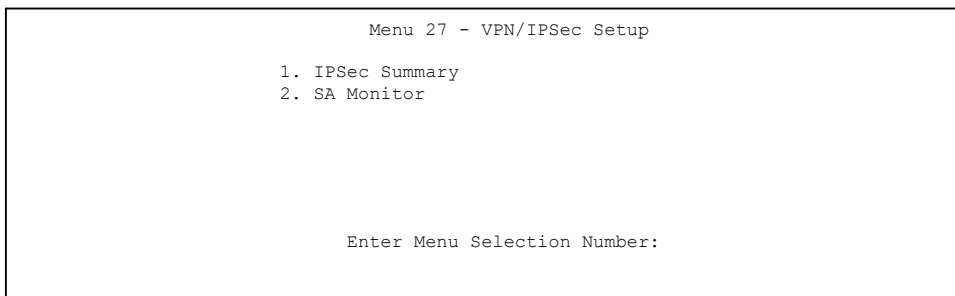

Figure 43-2 Menu 27 VPN/IPSec Setup

43.2 IPSec Summary Screen

Type 1 in menu 27 and then press [ENTER] to display **Menu 27.1 IPSec Summary**. This is a summary read-only menu of your IPSec rules (tunnels). Edit or create an IPSec rule by selecting an index number and then configuring the associated submenus.

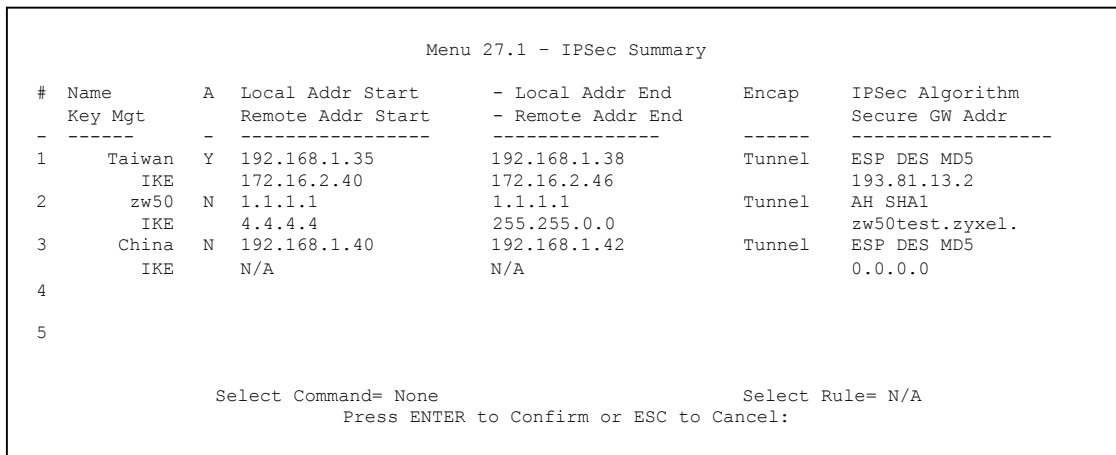

Figure 43-3 Menu 27.1 IPSec Summary

Table 43-1 Menu 27.1 IPSec Summary

FIELD	DESCRIPTION	EXAMPLE
#	This is the VPN policy index number.	1

Table 43-1 Menu 27.1 IPSec Summary

FIELD	DESCRIPTION	EXAMPLE
Name	This field displays the unique identification name for this VPN rule. The name may be up to 32 characters long but only 10 characters will be displayed here.	Taiwan
A	Y signifies that this VPN rule is active.	Y
Local Addr Start	When the Addr Type field in Menu 27.1.1 IPSec Setup is configured to Single , this is a static IP address on the LAN behind your Prestige. When the Addr Type field in Menu 27.1.1 IPSec Setup is configured to Range , this is the beginning (static) IP address, in a range of computers on the LAN behind your Prestige. When the Addr Type field in Menu 27.1.1 IPSec Setup is configured to SUBNET , this is a static IP address on the LAN behind your Prestige.	192.168.1.35
Local Addr End	When the Addr Type field in Menu 27.1.1 IPSec Setup is configured to Single , this is the same (static) IP address as in the Local Addr Start field. When the Addr Type field in Menu 27.1.1 IPSec Setup is configured to Range , this is the end (static) IP address, in a range of computers on the LAN behind your Prestige. When the Addr Type field in Menu 27.1.1 IPSec Setup is configured to SUBNET , this is a subnet mask on the LAN behind your Prestige.	192.168.1.38
Encap	This field displays Tunnel mode or Transport mode. See earlier for a discussion of these. You need to finish configuring the VPN policy in menu 27.1.1.1 or 27.1.1.2 if ??? is displayed.	Tunnel
IPSec Algorithm	This field displays the security protocols used for an SA. ESP provides confidentiality and integrity of data by encrypting the data and encapsulating it into IP packets. Encryption methods include 56-bit DES and 168-bit 3DES . NULL denotes a tunnel without encryption. AH (Authentication Header) provides strong integrity and authentication by adding authentication information to IP packets. This authentication information is calculated using header and payload data in the IP packet. This provides an additional level of security. AH choices are MD5 (default - 128 bits) and SHA -1 (160 bits). Both AH and ESP increase the Prestige's processing requirements and communications latency (delay). You need to finish configuring the VPN policy in menu 27.1.1.1 or 27.1.1.2 if ??? is displayed.	ESP DES MD5

Table 43-1 Menu 27.1 IPSec Summary

FIELD	DESCRIPTION	EXAMPLE
Key Mgt	This field displays the SA's type of key management, (IKE or Manual).	IKE
Remote Addr Start	<p>When the Addr Type field in Menu 27.1.1 IPSec Setup is configured to Single, this is a static IP address on the network behind the remote IPSec router.</p> <p>When the Addr Type field in Menu 27.1.1 IPSec Setup is configured to Range, this is the beginning (static) IP address, in a range of computers on the network behind the remote IPSec router.</p> <p>When the Addr Type field in Menu 27.1.1 IPSec Setup is configured to SUBNET, this is a static IP address on the network behind the remote IPSec router.</p> <p>This field displays N/A when you configure the Secure Gateway Addr field in SMT 27.1.1 to 0.0.0.0.</p>	172.16.2.40
Remote Addr End	<p>When the Addr Type field in Menu 27.1.1 IPSec Setup is configured to Single, this is the same (static) IP address as in the Remote Addr Start field.</p> <p>When the Addr Type field in Menu 27.1.1 IPSec Setup is configured to Range, this is the end (static) IP address, in a range of computers on the network behind the remote IPSec router.</p> <p>When the Addr Type field in Menu 27.1.1 IPSec Setup is configured to SUBNET, this is a subnet mask on the network behind the remote IPSec router.</p> <p>This field displays N/A when you configure the Secure Gateway Addr field in SMT 27.1.1 to 0.0.0.0.</p>	172.16.2.46
Secure GW Addr	This is the WAN IP address or the domain name (up to the first 15 characters are displayed) of the IPSec router with which you are making the VPN connection. This field displays 0.0.0.0 when you configure the Secure Gateway Addr field in SMT 27.1.1 to 0.0.0.0.	193.81.13.2

Table 43-1 Menu 27.1 IPSec Summary

FIELD	DESCRIPTION	EXAMPLE
Select Command	<p>Press [SPACE BAR] to choose from None, Edit, Delete, Go To Rule, Next Page or Previous Page and then press [ENTER]. You must select a rule in the next field when you choose the Edit, Delete or Go To commands.</p> <p>Select None and then press [ENTER] to go to the “Press ENTER to Confirm...” prompt.</p> <p>Use Edit to create or edit a rule. Use Delete to remove a rule. To edit or delete a rule, first make sure you are on the correct page. When a VPN rule is deleted, subsequent rules do <u>not</u> move up in the page list.</p> <p>Use Go To Rule to view the page where your desired rule is listed.</p> <p>Select Next Page or Previous Page to view the next or previous page of rules (respectively).</p>	None
Select Rule	Type the VPN rule index number you wish to edit or delete and then press [ENTER].	3
When you have completed this menu, press [ENTER] at the prompt “Press ENTER to Confirm...” to save your configuration, or press [ESC] at any time to cancel.		

43.3 IPSec Setup

Select **Edit** in the **Select Command** field; type the index number of a rule in the **Select Rule** field and press [ENTER] to edit the VPN using the menu shown next.

You must also configure menu 27.1.1.1 or menu 27.1.1.2 to fully configure and use a VPN.

```

Menu 27.1.1 - IPSec Setup

Index= 1          Name= Taiwan
Active= Yes      Keep Alive= No
Local ID type    Content:
My IP Addr= 0.0.0.0
Peer ID type     Content:
Secure Gateway Address= zw50test.zyxel.com.tw
Protocol= 0
Local:          Addr Type= SINGLE
                IP Addr Start= 1.1.1.1          End/Subnet Mask= N/A
                Port Start= 0                   End= N/A
Remote:        Addr Type= SUBNET
                IP Addr Start= 4.4.4.4          End/Subnet Mask= 255.255.0.0
                Port Start= 0                   End= N/A

Enable Replay Detection = No
Key Management= IKE
Edit Key Management Setup= No

Press ENTER to Confirm or ESC to Cancel:
    
```

Figure 43-4 Menu 27.1.1 IPSec Setup

The following table describes the fields in this menu.

Table 43-2 Menu 27.1.1 IPSec Setup

FIELD	DESCRIPTION	EXAMPLE
Index	This is the VPN rule index number you selected in the previous menu.	1
Name	Enter a unique identification name for this VPN rule. The name may be up to 32 characters long but only 10 characters will be displayed in Menu 27.1 - IPSec Summary .	Taiwan
Active	Press [SPACE BAR] to choose either Yes or No . Choose Yes and press [ENTER] to activate the VPN tunnel. This field determines whether a VPN rule is applied before a packet leaves the firewall.	Yes
Keep Alive	Press [SPACE BAR] to choose either Yes or No . Choose Yes and press [ENTER] to have the Prestige automatically re-initiate the SA after the SA lifetime times out, even if there is no traffic. The remote IPSec router must also have keep alive enabled in order for this feature to work.	No
Local ID type	Press [SPACE BAR] to choose IP , DNS , or E-mail and press [ENTER]. Select IP to identify this Prestige by its IP address. Select DNS to identify this Prestige by a domain name. Select E-mail to identify this Prestige by an e-mail address.	

Table 43-2 Menu 27.1.1 IPSec Setup

FIELD	DESCRIPTION	EXAMPLE
Content	<p>When you select IP in the Local ID Type field, type the IP address of your computer or leave the field blank to have the Prestige automatically use its own IP address.</p> <p>When you select DNS in the Local ID Type field, type a domain name (up to 31 characters) by which to identify this Prestige.</p> <p>When you select E-mail in the Local ID Type field, type an e-mail address (up to 31 characters) by which to identify this Prestige.</p> <p>The domain name or e-mail address that you use in the Content field is used for identification purposes only and does not need to be a real domain name or e-mail address.</p>	
My IP Addr	<p>Enter the IP address of your Prestige. The Prestige uses its current WAN IP address (static or dynamic) in setting up the VPN tunnel if you leave this field as 0.0.0.0.</p> <p>The VPN tunnel has to be rebuilt if this IP address changes.</p>	0.0.0.0
Peer ID type	<p>Press [SPACE BAR] to choose IP, DNS, or E-mail and press [ENTER].</p> <p>Select IP to identify the remote IPSec router by its IP address.</p> <p>Select DNS to identify the remote IPSec router by a domain name.</p> <p>Select E-mail to identify the remote IPSec router by an e-mail address.</p>	
Content	<p>When you select IP in the Peer ID Type field, type the IP address of the computer with which you will make the VPN connection or leave the field blank to have the Prestige automatically use the address in the Secure Gateway Address field.</p> <p>When you select DNS in the Peer ID Type field, type a domain name (up to 31 characters) by which to identify the remote IPSec router.</p> <p>When you select E-mail in the Peer ID Type field, type an e-mail address (up to 31 characters) by which to identify the remote IPSec router.</p> <p>The domain name or e-mail address that you use in the Content field is used for identification purposes only and does not need to be a real domain name or e-mail address. The domain name also does not have to match the remote router's IP address or what you configure in the Secure Gateway Address field below.</p>	

Table 43-2 Menu 27.1.1 IPSec Setup

FIELD	DESCRIPTION	EXAMPLE
Secure Gateway Address	Type the IP address or the domain name (up to 31 characters) of the IPSec router with which you're making the VPN connection. Set this field to 0.0.0.0 if the remote IPSec router has a dynamic WAN IP address (the Key Management field must be set to IKE , see later).	Zw50test.com. tw
Protocol	Enter 1 for ICMP, 6 for TCP, 17 for UDP, etc. 0 is the default and signifies any protocol.	0
Local	Local IP addresses must be static and correspond to the remote IPSec router's configured remote IP addresses. Two active SAs cannot have the local and remote IP address(es) both the same. Two active SAs can have the same local or remote IP address, but not both. You can configure multiple SAs between the same local and remote IP addresses, as long as only one is active at any time.	
Addr Type	Press [SPACE BAR] to choose SINGLE , RANGE , or SUBNET and press [ENTER]. Select SINGLE with a single IP address. Select RANGE for a specific range of IP addresses. Select SUBNET to specify IP addresses on a network by their subnet mask.	SINGLE
IP Addr Start	When the Addr Type field is configured to Single , enter a static IP address on the LAN behind your Prestige. When the Addr Type field is configured to Range , enter the beginning (static) IP address, in a range of computers on your LAN behind your Prestige. When the Addr Type is configured to SUBNET , this is a (static) IP address on the LAN behind your Prestige.	192.168.1.35
End/Subnet Mask	When the Addr Type field is configured to Single , this field is N/A . When the Addr Type field is configured to Range , enter the end (static) IP address, in a range of computers on the LAN behind your Prestige. When the Addr Type field is configured to SUBNET , this is a subnet mask on the LAN behind your Prestige.	192.168.1.38
Port Start	0 is the default and signifies any port. Type a port number from 0 to 65535. You cannot create a VPN tunnel if you try to connect using a port number that does not match this port number or range of port numbers. Some of the most common IP ports are: 21, FTP; 53, DNS; 23, Telnet; 80, HTTP; 25, SMTP; 110, POP3	0

Table 43-2 Menu 27.1.1 IPSec Setup

FIELD	DESCRIPTION	EXAMPLE
End	Enter a port number in this field to define a port range. This port number must be greater than that specified in the previous field. This field is N/A when 0 is configured in the Port Start field.	N/A
Remote	Remote IP addresses must be static and correspond to the remote IPSec router's configured local IP addresses. The remote fields are N/A when the Secure Gateway Address field is configured to 0.0.0.0. Two active SAs cannot have the local and remote IP address(es) both the same. Two active SAs can have the same local or remote IP address, but not both. You can configure multiple SAs between the same local and remote IP addresses, as long as only one is active at any time.	
Addr Type	Press [SPACE BAR] to choose SINGLE , RANGE , or SUBNET and press [ENTER]. Select SINGLE with a single IP address. Use RANGE for a specific range of IP addresses. Use SUBNET to specify IP addresses on a network by their subnet mask.	SUBNET
IP Addr Start	When the Addr Type field is configured to Single , enter a static IP address on the network behind the remote IPSec router. When the Addr Type field is configured to Range , enter the beginning (static) IP address, in a range of computers on the network behind the remote IPSec router. When the Addr Type field is configured to SUBNET , enter a static IP address on the network behind the remote IPSec router. This field displays N/A when you configure the Secure Gateway Address field to 0.0.0.0.	4.4.4.4
End/Subnet Mask	When the Addr Type field is configured to Single , this field is N/A . When the Addr Type field is configured to Range , enter the end (static) IP address, in a range of computers on the network behind the remote IPSec router. When the Addr Type field is configured to SUBNET , enter a subnet mask on the network behind the remote IPSec router. This field displays N/A when you configure the Secure Gateway Address field to 0.0.0.0.	255.255.0.0

Table 43-2 Menu 27.1.1 IPSec Setup

FIELD	DESCRIPTION	EXAMPLE
Port Start	0 is the default and signifies any port. Type a port number from 0 to 65535. Someone behind the remote IPSec router cannot create a VPN tunnel when attempting to connect using a port number that does not match this port number or range of port numbers. Some of the most common IP ports are: 21, FTP; 53, DNS; 23, Telnet; 80, HTTP; 25, SMTP; 110, POP3.	0
End	Enter a port number in this field to define a port range. This port number must be greater than that specified in the previous field. This field is N/A when 0 is configured in the Port Start field.	
Enable Replay Detection	As a VPN setup is processing intensive, the system is vulnerable to Denial of Service (DoS) attacks. The IPSec receiver can detect and reject old or duplicate packets to protect against replay attacks. Enable replay detection by setting this field to Yes . Press [SPACE BAR] to select Yes or No . Choose Yes and press [ENTER] to enable replay detection.	No
Key Management	Press [SPACE BAR] to choose either IKE or Manual and then press [ENTER]. Manual is useful for troubleshooting if you have problems using IKE key management.	IKE
Edit Key Management Setup	Press [SPACE BAR] to change the default No to Yes and then press [ENTER] to go to a key management menu for configuring your key management setup (described later). If you set the Key Management field to IKE , this will take you to Menu 27.1.1.1 – IKE Setup . If you set the Key Management field to Manual , this will take you to Menu 27.1.1.2 – Manual Setup .	No
When you have completed this menu, press [ENTER] at the prompt "Press ENTER to Confirm..." to save your configuration, or press [ESC] at any time to cancel.		

43.4 IKE Setup

To edit this menu, the **Key Management** field in **Menu 27.1.1 – IPSec Setup** must be set to **IKE**. Move the cursor to the **Edit Key Management Setup** field in **Menu 27.1.1 – IPSec Setup**; press [SPACE BAR] to select **Yes** and then press [ENTER] to display **Menu 27.1.1.1 – IKE Setup**.

```

Menu 27.1.1.1 - IKE Setup

Phase 1
Negotiation Mode= Main
Pre-Shared Key=
Encryption Algorithm = DES
Authentication Algorithm = SHA1
SA Life Time (Seconds)= 28800
Key Group= DH1

Phase 2
Active Protocol = ESP
Encryption Algorithm = DES
Authentication Algorithm = SHA1
SA Life Time (Seconds)= 28800
Encapsulation = Tunnel
Perfect Forward Secrecy (PFS)= None

Press ENTER to Confirm or ESC to Cancel:
    
```

Figure 43-5 Menu 27.1.1.1 IKE Setup

The following table describes the fields in this menu.

Table 43-3 Menu 27.1.1.1 IKE Setup

FIELD	DESCRIPTION	EXAMPLE
Phase 1		
Negotiation Mode	Press [SPACE BAR] to choose from Main or Aggressive and then press [ENTER]. See earlier for a discussion of these modes. Multiple SAs connecting through a secure gateway must have the same negotiation mode.	Main
Pre-Shared Key	Prestige gateways authenticate an IKE VPN session by matching pre-shared keys. Pre-shared keys are best for small networks with fewer than ten nodes. Enter your pre-shared key here. Enter up to 31 characters. Any character may be used, including spaces, but trailing spaces are truncated. Both ends of the VPN tunnel must use the same pre-shared key. You will receive a "PYLD_MALFORMED" (payload malformed) packet if the same pre-shared key is not used on both ends.	

Table 43-3 Menu 27.1.1.1 IKE Setup

FIELD	DESCRIPTION	EXAMPLE
Encryption Algorithm	<p>When DES is used for data communications, both sender and receiver must know the same secret key, which can be used to encrypt and decrypt the message or to generate and verify a message authentication code. Prestige DES encryption algorithm uses a 56-bit key.</p> <p>Triple DES (3DES), is a variation on DES that uses a 168-bit key. As a result, 3DES is more secure than DES. It also requires more processing power, resulting in slightly increased latency and decreased throughput.</p> <p>Press [SPACE BAR] to choose from 3DES or DES and then press [ENTER].</p>	DES
Authentication Algorithm	<p>MD5 (Message Digest 5) and SHA1 (Secure Hash Algorithm) are hash algorithms used to authenticate packet data. The SHA1 algorithm is generally considered stronger than MD5, but is slightly slower.</p> <p>Press [SPACE BAR] to choose from SHA1 or MD5 and then press [ENTER].</p>	SHA1
SA Life Time (Seconds)	<p>Define the length of time before an IKE Security Association automatically renegotiates in this field. It may range from 60 to 3,000,000 seconds (almost 35 days).</p> <p>A short SA Life Time increases security by forcing the two VPN gateways to update the encryption and authentication keys. However, every time the VPN tunnel renegotiates, all users accessing remote resources are temporarily disconnected.</p>	28800 (default)
Key Group	<p>You must choose a key group for phase 1 IKE setup. DH1 (default) refers to Diffie-Hellman Group 1 a 768 bit random number. DH2 refers to Diffie-Hellman Group 2 a 1024 bit (1Kb) random number.</p>	DH1
Phase 2		
Active Protocol	<p>Press [SPACE BAR] to choose from ESP or AH and then press [ENTER]. See earlier for a discussion of these protocols.</p>	ESP
Encryption Algorithm	<p>Press [SPACE BAR] to choose from NULL, 3DES or DES and then press [ENTER]. Select NULL to set up a tunnel without encryption.</p>	DES
Authentication Algorithm	<p>Press [SPACE BAR] to choose from SHA1 or MD5 and then press [ENTER].</p>	MD5
SA Life Time (Seconds)	<p>Define the length of time before an IPSec Security Association automatically renegotiates in this field. It may range from 60 to 3,000,000 seconds (almost 35 days).</p>	28800 (default)
Encapsulation	<p>Press [SPACE BAR] to choose from Tunnel mode or Transport mode and then press [ENTER]. See earlier for a discussion of these.</p>	Tunnel

Table 43-3 Menu 27.1.1.1 IKE Setup

FIELD	DESCRIPTION	EXAMPLE
Perfect Forward Secrecy (PFS)	Perfect Forward Secrecy (PFS) is disabled (None) by default in phase 2 IPsec SA setup. This allows faster IPsec setup, but is not so secure. Press [SPACE BAR] and choose from DH1 or DH2 to enable PFS. DH1 refers to Diffie-Hellman Group 1 a 768 bit random number. DH2 refers to Diffie-Hellman Group 2 a 1024 bit (1Kb) random number (more secure, yet slower).	None
When you have completed this menu, press [ENTER] at the prompt "Press ENTER to Confirm..." to save your configuration, or press [ESC] at any time to cancel.		

43.5 Manual Setup

You only configure **Menu 27.1.1.2 – Manual Setup** when you select **Manual** in the **Key Management** field in **Menu 27.1.1 – IPsec Setup**. Manual key management is useful if you have problems with **IKE** key management.

43.5.1 Active Protocol

This field is a combination of mode and security protocols used for the VPN. See the Web Configurator part on VPN for more information on these parameters.

Table 43-4 Active Protocol: Encapsulation and Security Protocol

MODE	SECURITY PROTOCOL
Tunnel	ESP
Transport	AH

43.5.2 Security Parameter Index (SPI)

To edit this menu, move the cursor to the **Edit Manual Setup** field in **Menu 27.1.1 – IPsec Setup** press [SPACE BAR] to select **Yes** and then press [ENTER] to go to **Menu 27.1.1.2 – Manual Setup**.

```

Menu 27.1.1.2 - Manual Setup
Active Protocol= ESP Tunnel

ESP Setup
SPI=
Encryption Algorithm= DES
Key1=
Key2= N/A
Key3= N/A
Authentication Algorithm= MD5
Key= N/A

AH Setup
SPI (Decimal)= N/A
Authentication Algorithm= N/A
Key=

Press ENTER to Confirm or ESC to Cancel:
    
```

Figure 43-6 Menu 27.1.1.2 Manual Setup

The following table describes the fields in this menu.

Table 43-5 Menu 27.1.1.2 Manual Setup

FIELD	DESCRIPTION	EXAMPLE
Active Protocol	Press [SPACE BAR] to choose from ESP Tunnel , ESP Transport , AH Tunnel or AH Transport and then press [ENTER]. Choosing an ESP combination causes the AH Setup fields to be non-applicable (N/A)	ESP Tunnel
ESP Setup	The ESP Setup fields are N/A if you chose an AH Active Protocol .	
SPI	The SPI must be unique and from one to four integers ("0" to "9").	1234
Encryption Algorithm	Press [SPACE BAR] to choose from NULL , 3DES or DES and then press [ENTER]. Fill in the Key1 field below when you choose DES and fill in fields Key1 to Key3 when you choose 3DES . Select NULL to set up a tunnel without encryption. When you select NULL , you do not enter any encryption keys.	DES
Key1	Enter a unique eight-character key. Any character may be used, including spaces, but trailing spaces are truncated. Fill in the Key1 field when you choose DES and fill in fields Key1 to Key3 when you choose 3DES .	89abcde
Key2	Enter a unique eight-character key. It can be comprised of any character including spaces (but trailing spaces are truncated).	

Table 43-5 Menu 27.1.1.2 Manual Setup

FIELD	DESCRIPTION	EXAMPLE
Key3	Enter a unique eight-character key. It can be comprised of any character including spaces (but trailing spaces are truncated).	
Authentication Algorithm	Press [SPACE BAR] to choose from MD5 or SHA1 and then press [ENTER].	MD5
Key	Enter the authentication key to be used by IPSec if applicable. The key must be unique. Enter 16 characters for MD5 authentication and 20 characters for SHA-1 authentication. Any character may be used, including spaces, but trailing spaces are truncated.	123456789a bcde
AH Setup	The AH Setup fields are N/A if you chose an ESP Active Protocol .	
SPI (Decimal)	The SPI must be from one to four unique decimal characters ("0" to "9") long.	N/A
Authentication Algorithm	Press [SPACE BAR] to choose from MD5 or SHA1 and then press [ENTER].	N/A
Key	Enter the authentication key to be used by IPSec if applicable. The key must be unique. Enter 16 characters for MD5 authentication and 20 characters for SHA-1 authentication. Any character may be used, including spaces, but trailing spaces are truncated.	N/A
When you have completed this menu, press [ENTER] at the prompt "Press ENTER to Confirm..." to save your configuration, or press [ESC] at any time to cancel.		

Chapter 44

SA Monitor

This chapter teaches you how to manage your SAs by using the SA Monitor in SMT menu 27.2.

44.1 SA Monitor Overview

A Security Association (SA) is the group of security settings related to a specific VPN tunnel. This menu (shown next) displays active VPN connections.

When there is outbound traffic but no inbound traffic, the SA times out automatically after two minutes. A tunnel with no outbound or inbound traffic is "idle" and does not timeout until the SA lifetime period expires. See the web configurator part on keep alive to have the Prestige renegotiate an IPSec SA when the SA lifetime expires, even if there is no traffic.

44.2 Using SA Monitor

1. Use the **Refresh** function to display active VPN connections.
2. Use the **Disconnect** function to cut off active connections.

Type 2 in **Menu 27 - VPN/IPSec Setup**, and then press [ENTER] to go to **Menu 27.2 - SA Monitor**.

```

Menu 27.2 - SA Monitor

#           Name           Encap.       IPSec ALgorithm
---          -----          -
001      Taiwan : 3.3.3.1 - 3.3.3.3.100      Tunnel      ESP DES MD5
002
003
004
005
006
007
008
009
010

                Select Command= Refresh
                Select Connection= N/A

Press ENTER to Confirm or ESC to Cancel:

```

Figure 44-1 Menu 27.2 SA Monitor

The following table describes the fields in this menu.

Table 44-1 Menu 27.2 SA Monitor

FIELD	DESCRIPTION	EXAMPLE
#	This is the security association index number.	
Name	<p>This field displays the identification name for this VPN policy. This name is unique for each connection where the secure gateway IP address is a public static IP address.</p> <p>When the secure gateway IP address is 0.0.0.0 (as discussed in the last chapter), there may be different connections using this same VPN rule. In this case, the name is followed by the remote IP address as configured in Menu 27.1.1. – IPSec Setup. Individual connections using the same VPN rule may be terminated without affecting other connections using the same rule.</p>	Taiwan
Encap.	This field displays Tunnel mode or Transport mode. See previous for discussion.	Tunnel
IPSec Algorithm	<p>This field displays the security protocols used for an SA. ESP provides confidentiality and integrity of data by encrypting the data and encapsulating it into IP packets. Encryption methods include 56-bit DES and 168-bit 3DES. NULL denotes a tunnel without encryption.</p> <p>An incoming SA may have an AH in addition to ESP. The Authentication Header provides strong integrity and authentication by adding authentication information to IP packets. This authentication information is calculated using header and payload data in the IP packet. This provides an additional level of security. AH choices are MD5 (default - 128 bits) and SHA -1(160 bits).</p> <p>Both AH and ESP increase Prestige processing requirements and communications latency (delay).</p>	ESP DES MD5
Select Command	<p>Press [SPACE BAR] to choose from Refresh, Disconnect, None, Next Page, or Previous Page and then press [ENTER]. You must select a connection in the next field when you choose the Disconnect command. Refresh displays current active VPN connections. None allows you to jump to the “Press ENTER to Confirm...” prompt.</p> <p>Select Next Page or Previous Page to view the next or previous page of rules (respectively).</p>	Refresh
Select Connection	Type the VPN connection index number that you want to disconnect and then press [ENTER].	1
When you have completed this menu, press [ENTER] at the prompt “Press ENTER to Confirm...” to save your configuration, or press [ESC] at any time to cancel.		

Chapter 45

Internal SPTGEN

45.1 Internal SPTGEN Overview

Internal SPTGEN (System Parameter Table Generator) is a configuration text file useful for efficient configuration of multiple Prestiges. Internal SPTGEN lets you configure, save and upload multiple menus at the same time using just one configuration text file – eliminating the need to navigate and configure individual SMT menus for each Prestige.

45.2 The Configuration Text File Format

All Internal SPTGEN text files conform to the following format:

```
<field identification number = field name = parameter values allowed =  
input>,
```

where <input> is your input conforming to <parameter values allowed>.

The figure shown next is an example of an Internal SPTGEN text file.

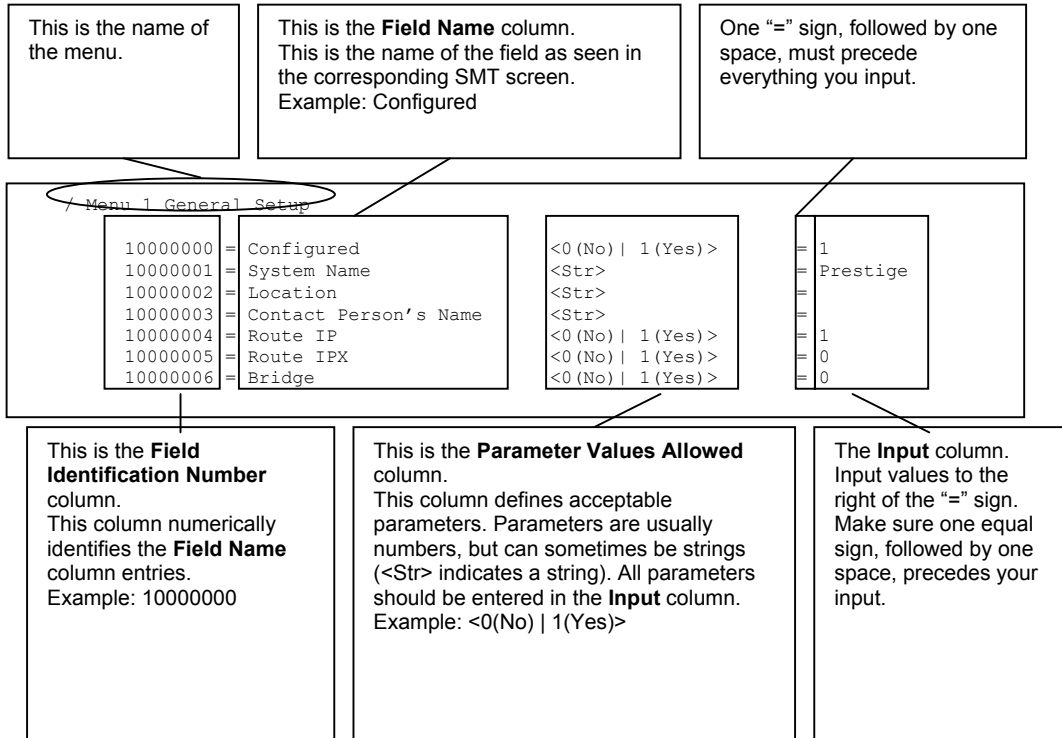

Figure 45-1 Configuration Text File Format: Column Descriptions

DO NOT alter or delete any field except parameters in the Input column.

For more text file examples, refer to the *Example Internal SPTGEN Screens* appendix.

45.2.1 Internal SPTGEN File Modification - Important Points to Remember

- Each parameter you enter must be preceded by one "=" sign and one space.
- Some parameters are dependent on others. For example, if you disable the **Configured** field in menu 1 (see *Figure 45-1*), then you disable every field in this menu.
- If you enter a parameter that is invalid in the **Input** column, the Prestige will not save the configuration and the command line will display the **Field Identification Number**. *Figure 45-2*, shown next, is an example of what the Prestige displays if you enter a value other than "0" or "1" in the **Input** column of **Field Identification Number** 1000000 (refer to *Figure 45-1*).

```
field value is not legal error:-1
ROM-t is not saved, error Line ID:10000000
reboot to get the original configuration
Bootbase Version: V2.02 | 2/22/2001 13:33:11
RAM: Size = 8192 Kbytes
FLASH: Intel 8M *2
```

Figure 45-2 Invalid Parameter Entered: Command Line Example

The Prestige will display the following if you enter parameter(s) that *are* valid.

```
Please wait for the system to write SPT text file(ROM-t)...
Bootbase Version: V2.02 | 2/22/2001 13:33:11
RAM: Size = 8192 Kbytes
FLASH: Intel 8M *2
```

Figure 45-3 Valid Parameter Entered: Command Line Example

45.3 Internal SPTGEN FTP Download Example

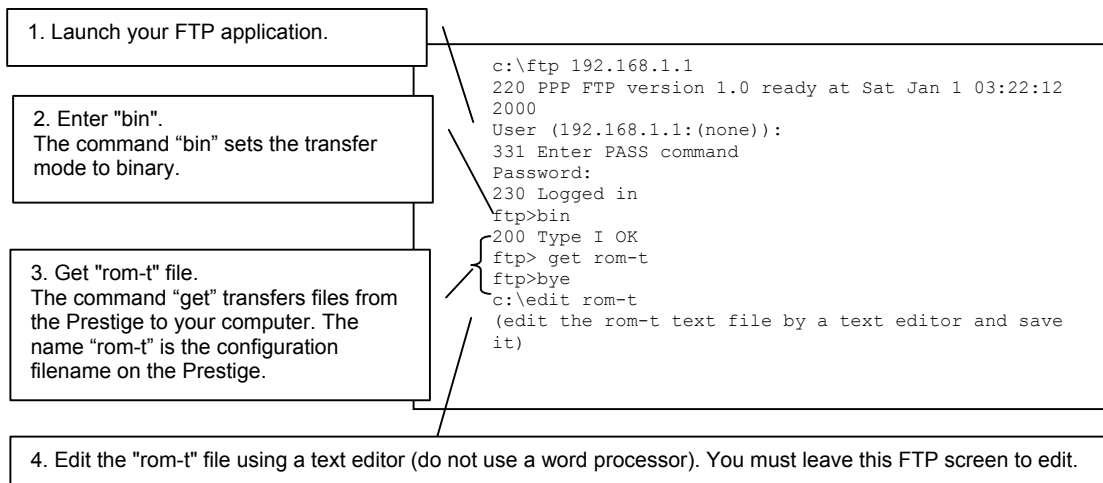

Figure 45-4 Internal SPTGEN FTP Download Example

You can rename your “rom-t” file when you save it to your computer but it must be named “rom-t” when you upload it to your Prestige.

45.4 Internal SPTGEN FTP Upload Example

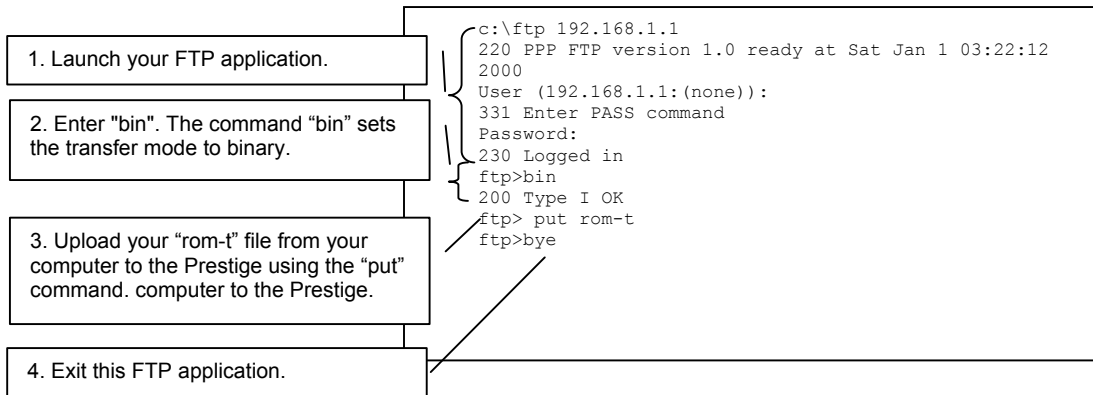

Figure 45-5 Internal SPTGEN FTP Upload Example

Part XII:

Appendices and Index

This part contains additional background information and an index or key terms.

Appendix A

Troubleshooting

This chapter covers potential problems and the corresponding remedies.

Problems Starting Up the Prestige

Chart A-1 Troubleshooting the Start-Up of Your Prestige

PROBLEM	CORRECTIVE ACTION
None of the LEDs turn on when I turn on the Prestige.	<p>Make sure that the Prestige's power adaptor is connected to the Prestige and plugged in to an appropriate power source. Check that the Prestige and the power source are both turned on.</p> <p>Turn the Prestige off and on.</p> <p>If the error persists, you may have a hardware problem. In this case, you should contact your vendor.</p>
I cannot access the Prestige via the console port.	1. Make sure the Prestige is connected to your computer's serial port.
	2. Make sure the communications program is configured correctly. The communications software should be configured as follows:
	<p>VT100 terminal emulation.</p> <p>9600 bps is the default speed on leaving the factory. Try other speeds in case the speed has been changed.</p> <p>No parity, 8 data bits, 1 stop bit, data flow set to none.</p>

Problems with the LAN LED

Chart A-2 Troubleshooting the LAN LED

PROBLEM	CORRECTIVE ACTION
The LAN LEDs do not turn on.	<p>Check your Ethernet cable connections and type (refer to the <i>Compact Guide</i> or <i>Read Me First</i> for details).</p> <p>Check for faulty Ethernet cables.</p> <p>Make sure your computer's Ethernet Card is working properly.</p>

Problems with the DSL LED

Chart A-3 Troubleshooting the DSL LED

PROBLEM	CORRECTIVE ACTION
The xDSL LED is off.	Check the telephone wire and connections between the Prestige DSL port and the wall jack.
	Make sure that the telephone company has checked your phone line and set it up for DSL service.
	Reset your ADSL line to reinitialize your link to the DSLAM. For details, refer to the <i>Maintenance</i> chapter (web configurator) or the System Information and Diagnosis chapter (SMT).

Problems with the LAN Interface

Chart A-4 Troubleshooting the LAN Interface

PROBLEM	CORRECTIVE ACTION
I cannot access the Prestige from the LAN.	<p>If the 10M/100M LEDs on the front panel are both off, refer to <i>Chart A-2 Troubleshooting the LAN LED</i>.</p> <p>Make sure that the IP address and the subnet mask of the Prestige and your computer(s) are on the same subnet.</p>
I cannot ping any computer on the LAN.	<p>If the 10M/100M LEDs on the front panel are both off, refer to <i>Chart A-2 Troubleshooting the LAN LED</i>.</p> <p>Make sure that the IP address and the subnet mask of the Prestige and the computers are on the same subnet.</p>

Problems with the WAN Interface

Chart A-5 Troubleshooting the WAN Interface

PROBLEM	CORRECTIVE ACTION
I cannot get a WAN IP address from the ISP.	<p>The ISP provides the WAN IP address after authenticating you. Authentication may be through the user name and password, the MAC address or the host name.</p> <p>The username and password apply to PPPoE and PPOA encapsulation only. Make sure that you have entered the correct Service Type, User Name and Password (be sure to use the correct casing). Refer to the <i>WAN Setup</i> chapter (web configurator) or the <i>Internet Access</i> chapter (SMT).</p>

Problems with Internet Access

Chart A-6 Troubleshooting Internet Access

PROBLEM	CORRECTIVE ACTION
I cannot access the Internet.	<p>Make sure the Prestige is turned on and connected to the network.</p> <p>If the DSL LED is off, refer to <i>Chart A-3 Troubleshooting the DSL LED</i>.</p> <p>Verify your WAN settings. Refer to the <i>WAN Setup</i> chapter (web configurator) or the <i>Internet Access</i> chapter (SMT).</p> <p>Make sure you entered the correct user name and password.</p> <p>If you use PPPoE pass through, make sure that bridge is turned on. See the <i>Menu 1 General Setup</i> chapter for details.</p> <p>For wireless stations, check that both the Prestige and wireless station(s) are using the same ESSID, channel and WEP keys (if WEP encryption is activated).</p>
Internet connection disconnects.	<p>Check the schedule rules. Refer to the <i>Call Scheduling</i> chapter (SMT).</p> <p>If you use PPPoA or PPPoE encapsulation, check the idle time-out setting. Refer to the <i>WAN</i> chapter (web configurator) or the <i>Remote Node Configuration</i> chapter (SMT).</p> <p>Contact your ISP.</p>

Problems with the Password

Chart A-7 Troubleshooting the Password

PROBLEM	CORRECTIVE ACTION
<p>I cannot access the Prestige.</p>	<p>The username is "admin". The default password is "1234". The Password and Username fields are case-sensitive. Make sure that you enter the correct password and username using the proper casing.</p> <p>If you have changed the password and have now forgotten it, you will need to upload the default configuration file (Refer to the <i>Resetting the Prestige</i> section in the <i>Introducing the Web Configurator</i> chapter). This restores all of the factory defaults including the password.</p>

Problems with the Web Configurator

Chart A-8 Troubleshooting the Web Configurator

PROBLEM	CORRECTIVE ACTION
<p>I cannot access the web configurator.</p>	<p>Refer to <i>Chart A-7 Troubleshooting the Password</i>.</p> <p>Make sure that there is not an SMT console session running.</p> <p>Check that you have enabled web service access. If you have configured a secured client IP address, your computer's IP address must match it. Refer to the chapter on remote management for details.</p> <p>For WAN access, you must configure remote management to allow server access from the Wan (or all). You must also configure a firewall rule to allow access from the WAN. Refer to the chapters on remote management and firewall for details.</p> <p>Your computer's and the Prestige's IP addresses must be on the same subnet for LAN access.</p> <p>If you changed the Prestige's LAN IP address, then enter the new one as the URL.</p> <p>Remove any filters in SMT menu 3.1 (LAN) or menu 11.5 (WAN) that block web service.</p> <p>See also the <i>Problems with Remote Management</i> section.</p>

Problems with Remote Management**Chart A-9 Troubleshooting Remote Management**

PROBLEM	CORRECTIVE ACTION
I cannot remotely manage the Prestige from the LAN or WAN.	Refer to the <i>Remote Management Limitations</i> section in the <i>Firmware and Configuration File Management</i> chapter (SMT) for scenarios when remote management may not be possible.
	Use the Prestige's WAN IP address when configuring from the WAN.
	Use the Prestige's LAN IP address when configuring from the LAN.
	Refer to <i>Chart A-4 Troubleshooting the LAN Interface</i> for instructions on checking your LAN connection.
	Refer to the <i>Problems with the WAN Interface</i> section for instructions on checking your WAN connection.
See also the <i>Problems with the Web Configurator</i> section.	

Appendix B

IP Subnetting

IP Addressing

Routers “route” based on the network number. The router that delivers the data packet to the correct destination host uses the host ID.

IP Classes

An IP address is made up of four octets (eight bits), written in dotted decimal notation, for example, 192.168.1.1. IP addresses are categorized into different classes. The class of an address depends on the value of its first octet.

- Class “A” addresses have a 0 in the left most bit. In a class “A” address the first octet is the network number and the remaining three octets make up the host ID.
- Class “B” addresses have a 1 in the left most bit and a 0 in the next left most bit. In a class “B” address the first two octets make up the network number and the two remaining octets make up the host ID.
- Class “C” addresses begin (starting from the left) with 1 1 0. In a class “C” address the first three octets make up the network number and the last octet is the host ID.
- Class “D” addresses begin with 1 1 1 0. Class “D” addresses are used for multicasting. (There is also a class “E” address. It is reserved for future use.)

Chart B-1 Classes of IP Addresses

IP ADDRESS:		OCTET 1	OCTET 2	OCTET 3	OCTET 4
Class A	0	Network number	Host ID	Host ID	Host ID
Class B	10	Network number	Network number	Host ID	Host ID
Class C	110	Network number	Network number	Network number	Host ID

Host IDs of all zeros or all ones are not allowed.

Therefore:

- A class “C” network (8 host bits) can have $2^8 - 2$ or 254 hosts.
- A class “B” address (16 host bits) can have $2^{16} - 2$ or 65534 hosts.

A class “A” address (24 host bits) can have $2^{24} - 2$ hosts (approximately 16 million hosts).

Since the first octet of a class “A” IP address must contain a “0”, the first octet of a class “A” address can have a value of 0 to 127.

Similarly the first octet of a class “B” must begin with “10”, therefore the first octet of a class “B” address has a valid range of 128 to 191. The first octet of a class “C” address begins with “110”, and therefore has a range of 192 to 223.

Chart B-2 Allowed IP Address Range By Class

CLASS	ALLOWED RANGE OF FIRST OCTET (BINARY)	ALLOWED RANGE OF FIRST OCTET (DECIMAL)
Class A	00000000 to 01111111	0 to 127
Class B	10000000 to 10111111	128 to 191
Class C	11000000 to 11011111	192 to 223
Class D	11100000 to 11101111	224 to 239

Subnet Masks

A subnet mask is used to determine which bits are part of the network number, and which bits are part of the host ID (using a logical AND operation). A subnet mask has 32 bits; each bit of the mask corresponds to a bit of the IP address. If a bit in the subnet mask is a “1” then the corresponding bit in the IP address is part of the network number. If a bit in the subnet mask is “0” then the corresponding bit in the IP address is part of the host ID.

Subnet masks are expressed in dotted decimal notation just as IP addresses are. The “natural” masks for class A, B and C IP addresses are as follows.

Chart B-3 “Natural” Masks

CLASS	NATURAL MASK
A	255.0.0.0
B	255.255.0.0
C	255.255.255.0

Subnetting

With subnetting, the class arrangement of an IP address is ignored. For example, a class C address no longer has to have 24 bits of network number and 8 bits of host ID. With subnetting, some of the host ID bits are converted into network number bits. By convention, subnet masks always consist of a continuous sequence of ones beginning from the left most bit of the mask, followed by a continuous sequence of zeros, for a total number of 32 bits.

Since the mask is always a continuous number of ones beginning from the left, followed by a continuous number of zeros for the remainder of the 32 bit mask, you can simply specify the number of ones instead of writing the value of each octet. This is usually specified by writing a “/” followed by the number of bits in the mask after the address.

For example, 192.1.1.0 /25 is equivalent to saying 192.1.1.0 with mask 255.255.255.128.

The following table shows all possible subnet masks for a class “C” address using both notations.

Chart B-4 Alternative Subnet Mask Notation

SUBNET MASK IP ADDRESS	SUBNET MASK “1” BITS	LAST OCTET BIT VALUE
255.255.255.0	/24	0000 0000
255.255.255.128	/25	1000 0000
255.255.255.192	/26	1100 0000
255.255.255.224	/27	1110 0000
255.255.255.240	/28	1111 0000
255.255.255.248	/29	1111 1000
255.255.255.252	/30	1111 1100

The first mask shown is the class “C” natural mask. Normally if no mask is specified it is understood that the natural mask is being used.

Example: Two Subnets

As an example, you have a class “C” address 192.168.1.0 with subnet mask of 255.255.255.0.

	NETWORK NUMBER	HOST ID
IP Address	192.168.1.	0
IP Address (Binary)	11000000.10101000.00000001.	00000000
Subnet Mask	255.255.255.	0
Subnet Mask (Binary)	11111111.11111111.11111111.	00000000

The first three octets of the address make up the network number (class “C”). You want to have two separate networks.

Divide the network 192.168.1.0 into two separate subnets by converting one of the host ID bits of the IP address to a network number bit. The “borrowed” host ID bit can be either “0” or “1” thus giving two subnets; 192.168.1.0 with mask 255.255.255.128 and 192.168.1.128 with mask 255.255.255.128.

In the following charts, shaded/bolded last octet bit values indicate host ID bits “borrowed” to form network ID bits. The number of “borrowed” host ID bits determines the number of subnets you can have. The remaining number of host ID bits (after “borrowing”) determines the number of hosts you can have on each subnet.

Chart B-5 Subnet 1

	NETWORK NUMBER	LAST OCTET BIT VALUE
IP Address	192.168.1.	0
IP Address (Binary)	11000000.10101000.00000001.	0 0000000
Subnet Mask	255.255.255.	128
Subnet Mask (Binary)	11111111.11111111.11111111.	1 0000000
Subnet Address: 192.168.1.0		Lowest Host ID: 192.168.1.1
Broadcast Address: 192.168.1.127		Highest Host ID: 192.168.1.126

Chart B-6 Subnet 2

	NETWORK NUMBER	LAST OCTET BIT VALUE
IP Address	192.168.1.	128
IP Address (Binary)	11000000.10101000.00000001.	1 0000000
Subnet Mask	255.255.255.	128
Subnet Mask (Binary)	11111111.11111111.11111111.	1 0000000
Subnet Address: 192.168.1.128		Lowest Host ID: 192.168.1.129
Broadcast Address: 192.168.1.255		Highest Host ID: 192.168.1.254

The remaining 7 bits determine the number of hosts each subnet can have. Host IDs of all zeros represent the subnet itself and host IDs of all ones are the broadcast address for that subnet, so the actual number of hosts available on each subnet in the example above is $2^7 - 2$ or 126 hosts for each subnet.

192.168.1.0 with mask 255.255.255.128 is the subnet itself, and 192.168.1.127 with mask 255.255.255.128 is the directed broadcast address for the first subnet. Therefore, the lowest IP address that can be assigned to an actual host for the first subnet is 192.168.1.1 and the highest is 192.168.1.126. Similarly the host ID range for the second subnet is 192.168.1.129 to 192.168.1.254.

Example: Four Subnets

The above example illustrated using a 25-bit subnet mask to divide a class “C” address space into two subnets. Similarly to divide a class “C” address into four subnets, you need to “borrow” two host ID bits to give four possible combinations of 00, 01, 10 and 11. The subnet mask is 26 bits (11111111.11111111.11111111.11000000) or 255.255.255.192. Each subnet contains 6 host ID bits, giving $2^6 - 2$ or 62 hosts for each subnet (all 0's is the subnet itself, all 1's is the broadcast address on the subnet).

Chart B-7 Subnet 1

	NETWORK NUMBER	LAST OCTET BIT VALUE
IP Address	192.168.1.	0
IP Address (Binary)	11000000.10101000.00000001.	00000000
Subnet Mask (Binary)	11111111.11111111.11111111.	11000000
Subnet Address: 192.168.1.0	Lowest Host ID: 192.168.1.1	
Broadcast Address: 192.168.1.63	Highest Host ID: 192.168.1.62	

Chart B-8 Subnet 2

	NETWORK NUMBER	LAST OCTET BIT VALUE
IP Address	192.168.1.	64
IP Address (Binary)	11000000.10101000.00000001.	01000000
Subnet Mask (Binary)	11111111.11111111.11111111.	11000000
Subnet Address: 192.168.1.64	Lowest Host ID: 192.168.1.65	
Broadcast Address: 192.168.1.127	Highest Host ID: 192.168.1.126	

Chart B-9 Subnet 3

	NETWORK NUMBER	LAST OCTET BIT VALUE
IP Address	192.168.1.	128
IP Address (Binary)	11000000.10101000.00000001.	10000000
Subnet Mask (Binary)	11111111.11111111.11111111.	11000000
Subnet Address: 192.168.1.128	Lowest Host ID: 192.168.1.129	
Broadcast Address: 192.168.1.191	Highest Host ID: 192.168.1.190	

Chart B-10 Subnet 4

	NETWORK NUMBER	LAST OCTET BIT VALUE

IP Address	192.168.1.	192
IP Address (Binary)	11000000.10101000.00000001.	11 000000
Subnet Mask (Binary)	11111111.11111111.11111111.	11 000000
Subnet Address: 192.168.1.192		Lowest Host ID: 192.168.1.193
Broadcast Address: 192.168.1.255		Highest Host ID: 192.168.1.254

Example Eight Subnets

Similarly use a 27-bit mask to create 8 subnets (001, 010, 011, 100, 101, 110).

The following table shows class C IP address last octet values for each subnet.

Chart B-11 Eight Subnets

SUBNET	SUBNET ADDRESS	FIRST ADDRESS	LAST ADDRESS	BROADCAST ADDRESS
1	0	1	30	31
2	32	33	62	63
3	64	65	94	95
4	96	97	126	127
5	128	129	158	159
6	160	161	190	191
7	192	193	222	223
8	224	223	254	255

The following table is a summary for class “C” subnet planning.

Chart B-12 Class C Subnet Planning

NO. “BORROWED” HOST BITS	SUBNET MASK	NO. SUBNETS	NO. HOSTS PER SUBNET
1	255.255.255.128 (/25)	2	126
2	255.255.255.192 (/26)	4	62
3	255.255.255.224 (/27)	8	30
4	255.255.255.240 (/28)	16	14
5	255.255.255.248 (/29)	32	6

6	255.255.255.252 (/30)	64	2
7	255.255.255.254 (/31)	128	1

Subnetting With Class A and Class B Networks.

For class “A” and class “B” addresses the subnet mask also determines which bits are part of the network number and which are part of the host ID.

A class “B” address has two host ID octets available for subnetting and a class “A” address has three host ID octets (see *Chart B-1*) available for subnetting.

The following table is a summary for class “B” subnet planning.

Chart B-13 Class B Subnet Planning

NO. “BORROWED” HOST BITS	SUBNET MASK	NO. SUBNETS	NO. HOSTS PER SUBNET
1	255.255.128.0 (/17)	2	32766
2	255.255.192.0 (/18)	4	16382
3	255.255.224.0 (/19)	8	8190
4	255.255.240.0 (/20)	16	4094
5	255.255.248.0 (/21)	32	2046
6	255.255.252.0 (/22)	64	1022
7	255.255.254.0 (/23)	128	510
8	255.255.255.0 (/24)	256	254
9	255.255.255.128 (/25)	512	126
10	255.255.255.192 (/26)	1024	62
11	255.255.255.224 (/27)	2048	30
12	255.255.255.240 (/28)	4096	14
13	255.255.255.248 (/29)	8192	6

Chart B-13 Class B Subnet Planning

NO. "BORROWED" HOST BITS	SUBNET MASK	NO. SUBNETS	NO. HOSTS PER SUBNET
14	255.255.255.252 (/30)	16384	2
15	255.255.255.254 (/31)	32768	1

Appendix C

Wireless LAN and IEEE 802.11

A wireless LAN (WLAN) provides a flexible data communications system that you can use to access various services (navigating the Internet, email, printer services, etc.) without the any expensive network-cabling infrastructure. In effect a wireless LAN environment provides you the freedom to stay connected to the network while in the coverage area.

Benefits of a Wireless LAN

1. Access to network services in areas otherwise hard or expensive to wire, such as historical buildings, buildings with asbestos materials and classrooms.
2. Doctors and nurses can access a complete patient's profile on a handheld or notebook computer upon entering a patient's room.
3. It allows flexible workgroups a lower total cost of ownership for networks that are frequently reconfigured.
4. Conference room users can access the network as they move from meeting to meeting- accessing up-to-date information that facilitates the ability to communicate decisions "on the fly".
5. It provides campus-wide networking coverage, allowing enterprises the roaming capability to set up easy-to-use wireless networks that transparently covers an entire campus.

IEEE 802.11

The 1997 completion of the IEEE 802.11 standard for wireless LANs (WLANs) was a first important step in the evolutionary development of wireless networking technologies. The standard was developed to maximize interoperability between differing brands of wireless LANs and to introduce a variety of performance improvements and benefits.

The IEEE 802.11 specifies three different transmission methods for the PHY, the layer responsible for transferring data between nodes. Two of the methods use spread spectrum RF signals, Direct Sequence Spread Spectrum (DSSS) and Frequency-Hopping Spread Spectrum (FHSS), in the 2.4 to 2.4825 GHz unlicensed ISM (Industrial, Scientific and Medical) band. The third method is infrared technology, using very high frequencies, just below visible light in the electromagnetic spectrum to carry data.

Ad-hoc Wireless LAN Configuration

The simplest WLAN configuration is an independent (Ad-hoc) WLAN that connects a set of computers with wireless nodes or stations (STA), which is called a Basic Service Set (BSS). In the most basic form, a wireless LAN connects a set of computers with wireless adapters. Any time two or more wireless adapters are within range of each other, they can set up an independent network, which is commonly referred to as an Ad-hoc network or Independent Basic Service Set (IBSS). See the following diagram of an example of an Ad-hoc wireless LAN.

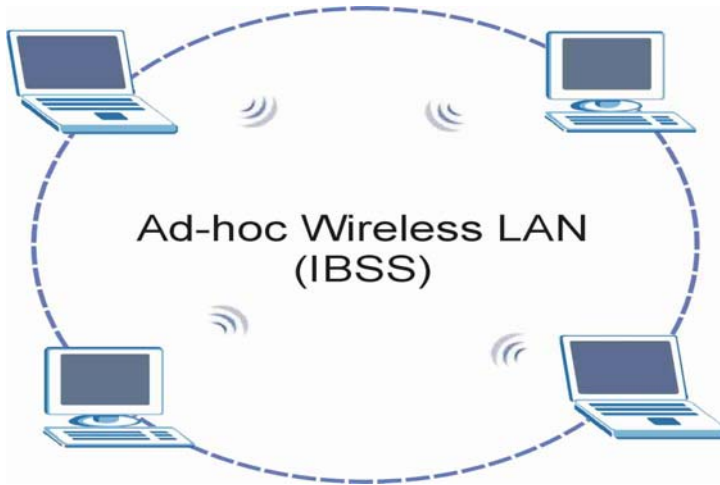

Diagram C-1 Peer-to-Peer Communication in an Ad-hoc Network

Infrastructure Wireless LAN Configuration

For Infrastructure WLANs, multiple access points (APs) link the WLAN to the wired network and allow users to efficiently share network resources. The Access Points not only provide communication with the wired network but also mediate wireless network traffic in the immediate neighborhood. Multiple access points can provide wireless coverage for an entire building or campus. All communications between stations or between a station and a wired network client go through the access point.

The Extended Service Set (ESS) shown in the next figure consists of a series of overlapping BSSs (each containing an access point) connected together by means of a Distribution System (DS). Although the DS could be any type of network, it is almost invariably an Ethernet LAN. Mobile nodes can roam between access points and seamless campus-wide coverage is possible.

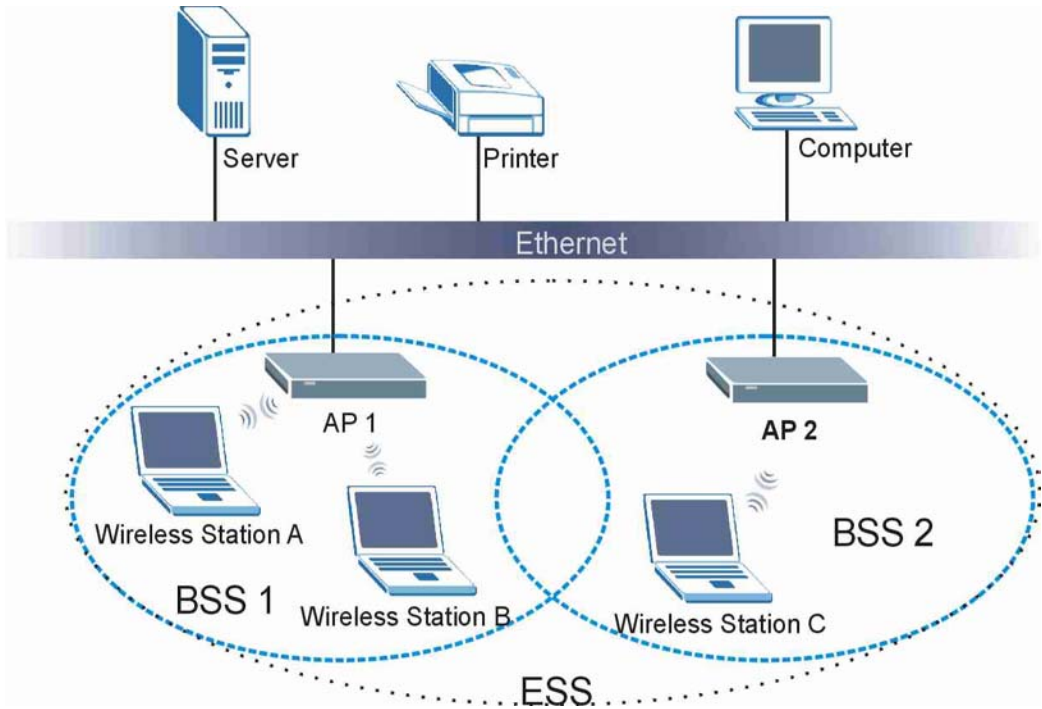

Diagram C-2 ESS Provides Campus-Wide Coverage

Appendix D

Antenna Selection and Positioning Recommendation

An antenna couples RF signals onto air. A transmitter within a wireless device sends an RF signal to the antenna, which propagates the signal through the air. The antenna also operates in reverse by capturing RF signals from the air.

Choosing the right antennas and positioning them properly increases the range and coverage area of a wireless LAN.

Antenna Characteristics

➤ Frequency

An antenna in the frequency of 2.4GHz (IEEE 802.11b) or 5GHz(IEEE 802.11a) is needed to communicate efficiently in a wireless LAN.

➤ Radiation Pattern

A radiation pattern is a diagram that allows you to visualize the shape of the antenna's coverage area.

➤ Antenna Gain

Antenna gain, measured in dB (decibel), is the increase in coverage within the RF beam width. Higher antenna gain improves the range of the signal for better communications.

For an indoor site, each 1 dB increase in antenna gain results in a range increase of approximately 2.5%. For an unobstructed outdoor site, each 1dB increase in gain results in a range increase of approximately 5%. Actual results may vary depending on the network environment.

Antenna gain is sometimes specified in dBi, which is how much the antenna increases the signal power compared to using an isotropic antenna. An isotropic antenna is a theoretical perfect antenna that sends out radio signals equally well in all directions. dBi represents the true gain that the antenna provides.

Types of Antennas For WLAN

There are two types of antennas used for wireless LAN applications.

- Omni-directional antennas send the RF signal out in all directions on a horizontal plane. The coverage area is torus-shaped (like a donut) which makes these antennas ideal for a room environment. With a wide coverage area, it is possible to make circular overlapping coverage areas with multiple access points.

- Directional antennas concentrate the RF signal in a beam, like a flashlight. The angle of the beam width determines the direction of the coverage pattern; typically ranges from 20 degrees (less directional) to 90 degrees (very directional). The directional antennas are ideal for hallways and outdoor point-to-point applications.

Positioning Antennas

In general, antennas should be mounted as high as practically possible and free of obstructions. In point-to – point application, position both transmitting and receiving antenna at the same height and in a direct line of sight to each other to attend the best performance.

For omni-directional antennas mounted on a table, desk, and so on, point the antenna up. For omni-directional antennas mounted on a wall or ceiling, point the antenna down. For a single AP application, place omni-directional antennas as close to the center of the coverage area as possible.

For directional antennas, point the antenna in the direction of the desired coverage area.

Connector Type

The Prestige is equipped with a reverse polarity SMA jack, so it will work with any 2.4GHz wireless antenna with a reverse polarity SMA plug.

Appendix E

PPPoE

PPPoE in Action

An ADSL modem bridges a PPP session over Ethernet (PPP over Ethernet, RFC 2516) from your PC to an ATM PVC (Permanent Virtual Circuit) that connects to a xDSL Access Concentrator where the PPP session terminates (see the next figure). One PVC can support any number of PPP sessions from your LAN. PPPoE provides access control and billing functionality in a manner similar to dial-up services using PPP.

Benefits of PPPoE

PPPoE offers the following benefits:

1. It provides you with a familiar dial-up networking (DUN) user interface.
2. It lessens the burden on the carriers of provisioning virtual circuits all the way to the ISP on multiple switches for thousands of users. For GSTN (PSTN and ISDN), the switching fabric is already in place.
3. It allows the ISP to use the existing dial-up model to authenticate and (optionally) to provide differentiated services.

Traditional Dial-up Scenario

The following diagram depicts a typical hardware configuration where the PCs use traditional dial-up networking.

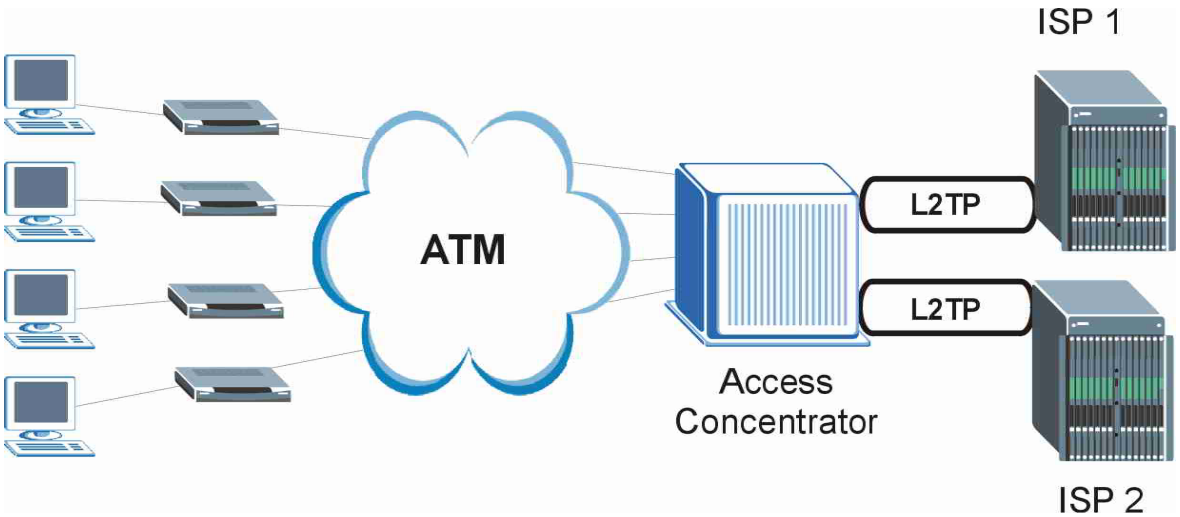

Diagram E-1 Single-PC per Router Hardware Configuration

How PPPoE Works

The PPPoE driver makes the Ethernet appear as a serial link to the PC and the PC runs PPP over it, while the modem bridges the Ethernet frames to the Access Concentrator (AC). Between the AC and an ISP, the AC is acting as a L2TP (Layer 2 Tunneling Protocol) LAC (L2TP Access Concentrator) and tunnels the PPP frames to the ISP. The L2TP tunnel is capable of carrying multiple PPP sessions.

With PPPoE, the VC (Virtual Circuit) is equivalent to the dial-up connection and is between the modem and the AC, as opposed to all the way to the ISP. However, the PPP negotiation is between the PC and the ISP.

Prestige as a PPPoE Client

When using the Prestige as a PPPoE client, the PCs on the LAN see only Ethernet and are not aware of PPPoE. This alleviates the administrator from having to manage the PPPoE clients on the individual PCs.

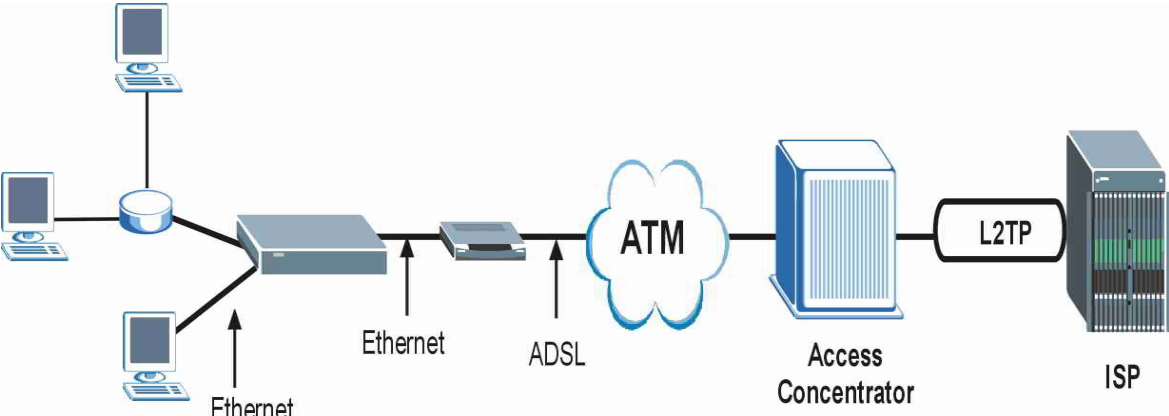

Diagram E-2 Prestige as a PPPoE Client

Appendix F

Virtual Circuit Topology

ATM is a connection-oriented technology, meaning that it sets up virtual circuits over which end systems communicate. The terminology for virtual circuits is as follows:

- Virtual Channel Logical connections between ATM switches
- Virtual Path A bundle of virtual channels
- Virtual Circuit A series of virtual paths between circuit end points

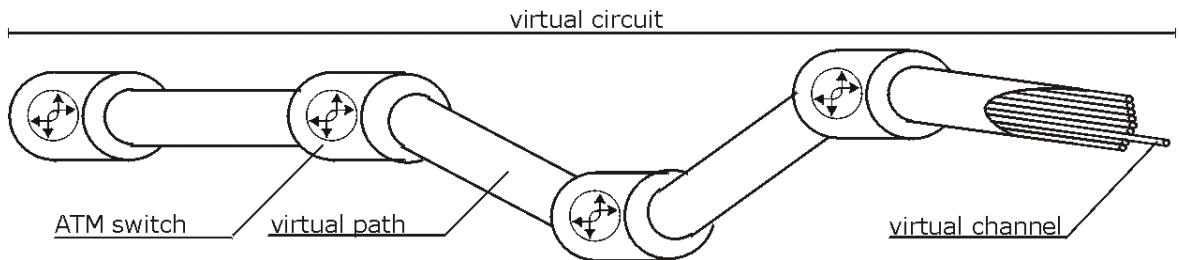

Diagram F-1 Virtual Circuit Topology

Think of a virtual path as a cable that contains a bundle of wires. The cable connects two points and wires within the cable provide individual circuits between the two points. In an ATM cell header, a VPI (Virtual Path Identifier) identifies a link formed by a virtual path; a VCI (Virtual Channel Identifier) identifies a channel within a virtual path.

The VPI and VCI identify a virtual path, that is, termination points between ATM switches. A series of virtual paths make up a virtual circuit.

Your service provider should supply you with VPI/VCI numbers.

Appendix G

Power Adaptor Specifications

Prestige 653 HWI

NORTH AMERICAN PLUG STANDARDS	
AC Power Adapter Model	DV-1215A
Input Power	AC120Volts/60Hz/30W
Output Power	AC16Volts/1.25A
Power Consumption	14 W
Safety Standards	UL, CUL, CSA (UL 1310, CSA C22.2 No.223)
NORTH AMERICAN PLUG STANDARDS	
AC Power Adapter Model	AA-121A25
Input Power	AC120Volts/60Hz/19W
Output Power	AC 16Volts/ 1.25A
Power Consumption	14W
Safety Standards	UL, CUL (UL 1310, CSA C22.2 No.223)
EUROPEAN PLUG STANDARDS	
AC Power Adapter Model	AA-121A3BN
Input Power	AC230Volts/50Hz/140mA
Output Power	AC16Volts/1.3A
Power Consumption	14W
Safety Standards	ITS-GS, CE (EN 60950)
UNITED KINGDOM PLUG STANDARDS	
AC Power Adapter Model	AA-121A3D
Input Power	AC230Volts/50Hz/140mA
Output Power	AC16Volts/1.3A

Power Consumption	14W
Safety Standards	ITS-GS, CE (EN 60950)

Appendix H

Example Internal SPTGEN Screens

This appendix covers Prestige Internal SPTGEN screens.

Abbreviations Used in the Example Internal SPTGEN Screens Table

ABBREVIATION	MEANING
FIN	Field Identification Number (not seen in SMT screens)
FN	Field Name
PVA	Parameter Values Allowed
INPUT	An example of what you may enter

The following are Internal SPTGEN screens associated with the SMT screens of your Prestige.

Example Internal SPTGEN Screens Table

/ MENU 1 GENERAL SETUP (SMT MENU 1)			
FIN	FN	PVA	INPUT
10000000 =	Configured	<0(No) 1(Yes)>	= 0
10000001 =	System Name	<Str>	= Prestige
10000002 =	Location	<Str>	=
10000003 =	Contact Person's Name	<Str>	=
10000004 =	Route IP	<0(No) 1(Yes)>	= 1
10000006 =	Bridge	<0(No) 1(Yes)>	= 0

/ MENU 3.1 GENERAL ETHERNET SETUP (SMT MENU 3.1)			
FIN	FN	PVA	INPUT
30100001 =	Input Protocol filters Set 1		= 2
30100002 =	Input Protocol filters Set 2		= 256
30100003 =	Input Protocol filters Set 3		= 256
30100004 =	Input Protocol filters Set 4		= 256
30100005 =	Input device filters Set 1		= 256
30100006 =	Input device filters Set 2		= 256
30100007 =	Input device filters Set 3		= 256
30100008 =	Input device filters Set 4		= 256
30100009 =	Output protocol filters Set 1		= 256
30100010 =	Output protocol filters Set 2		= 256
30100011 =	Output protocol filters Set 3		= 256
30100012 =	Output protocol filters Set 4		= 256
30100013 =	Output device filters Set 1		= 256
30100014 =	Output device filters Set 2		= 256
30100015 =	Output device filters Set 3		= 256
30100016 =	Output device filters Set 4		= 256
/ MENU 3.2 TCP/IP AND DHCP ETHERNET SETUP (SMT MENU 3.2)			
FIN	FN	PVA	INPUT
30200001 =	DHCP	<0(None) 1(Server) 2(Relay)>	= 0
30200002 =	Client IP Pool Starting Address		= 192.168
30200003 =	Size of Client IP Pool		= 32
30200004 =	Primary DNS Server		= 0.0.0.0
30200005 =	Secondary DNS Server		= 0.0.0.0
30200006 =	Remote DHCP Server		= 0.0.0.0

The valid parameters for a set are 1-12. Type "256" if you do not want to select a set.

This value must be between 1-254.

30200008 =	IP Address		= 172.21.2.200
30200009 =	IP Subnet Mask		= 16
30200010 =	RIP Direction	<0(None) 1(Both) 2(In Only) 3(Out Only)>	= 0
30200011 =	Version	<0(Rip-1) 1(Rip-2B) 2(Rip-2M)>	= 0
30200012 =	Multicast	<0(IGMP-v2) 1(IGMP-v1) 2(None)>	= 2
30200013 =	IP Policies Set 1 (1~12)		= 256
30200014 =	IP Policies Set 2 (1~12)		= 256
30200015 =	IP Policies Set 3 (1~12)		= 256
30200016 =	IP Policies Set 4 (1~12)		= 256
/ MENU 3.2.1 IP ALIAS SETUP (SMT MENU 3.2.1)			
FIN	FN	PVA	INPUT
30201001 =	IP Alias 1	<0(No) 1(Yes)>	= 0
30201002 =	IP Address		= 0.0.0.0
30201003 =	IP Subnet Mask		= 0
30201004 =	RIP Direction	<0(None) 1(Both) 2(In Only) 3(Out Only)>	= 0
30201005 =	Version	<0(Rip-1) 1(Rip-2B) 2(Rip-2M)>	= 0
30201006 =	IP Alias #1 Incoming protocol filters Set 1		= 256
30201007 =	IP Alias #1 Incoming protocol filters Set 2		= 256
30201008 =	IP Alias #1 Incoming protocol filters Set 3		= 256
30201009 =	IP Alias #1 Incoming protocol filters Set 4		= 256

This value must be between 0-32.

This value must be between 0-32.

30201010 =	IP Alias #1 Outgoing protocol filters Set 1		= 256
30201011 =	IP Alias #1 Outgoing protocol filters Set 2		= 256
30201012 =	IP Alias #1 Outgoing protocol filters Set 3		= 256
30201013 =	IP Alias #1 Outgoing protocol filters Set 4		= 256
30201014 =	IP Alias 2 <0(No) 1(Yes)>		= 0
30201015 =	IP Address		= 0.0.0.0
30201016 =	IP Subnet Mask		= 0
30201017 =	RIP Direction	<0(None) 1(Both) 2(In Only) 3(Out Only)>	= 0
30201018 =	Version	<0(Rip-1) 1(Rip-2B) 2(Rip-2M)>	= 0
30201019 =	IP Alias #2 Incoming protocol filters Set 1		= 256
30201020 =	IP Alias #2 Incoming protocol filters Set 2		= 256
30201021 =	IP Alias #2 Incoming protocol filters Set 3		= 256
30201022 =	IP Alias #2 Incoming protocol filters Set 4		= 256
30201023 =	IP Alias #2 Outgoing protocol filters Set 1		= 256
30201024 =	IP Alias #2 Outgoing protocol filters Set 2		= 256
30201025 =	IP Alias #2 Outgoing protocol filters Set 3		= 256
30201026 =	IP Alias #2 Outgoing protocol filters Set 4		= 256
*/ MENU 3.5 WIRELESS LAN SETUP (SMT MENU 3.5)			
30500001 =	ESSID		Wireless

30500002 =	Hide ESSID	<0(No) 1(Yes)>	= 0
30500003 =	Channel ID	<1 2 3 4 5 6 7 8 9 10 11 12 13>	= 1
30500004 =	RTS Threshold	<0 ~ 2432>	= 2432
30500005 =	FRAG. Threshold	<256 ~ 2432>	= 2432
30500006 =	WEP	<0(DISABLE) 1(64-bit WEP) 2(128-bit WEP)>	= 0
30500007 =	Default Key	<1 2 3 4>	= 0
30500008 =	WEP Key1		=
30500009 =	WEP Key2		=
30500010 =	WEP Key3		=
30500011 =	WEP Key4		=
*/ MENU 3.5.1 WLAN MAC ADDRESS FILTER (SMT MENU 3.5.1)			
30501001 =	Mac Filter Active	<0(No) 1(Yes)>	= 0
30501002 =	Filter Action	<0(Allow) 1(Deny)>	= 0
30501003 =	Address 1		= 00:00:00:00:00:00
30501004 =	Address 2		= 00:00:00:00:00:00
30501005 =	Address 3		= 00:00:00:00:00:00
Continued
30501034 =	Address 32		= 00:00:00:00:00:00
/ MENU 4 INTERNET ACCESS SETUP (SMT MENU 4)			
FIN	FN	PVA	INPUT
40000000 =	Configured	<0(No) 1(Yes)>	= 1
40000001 =	ISP	<0(No) 1(Yes)>	= 1
40000002 =	Active	<0(No) 1(Yes)>	= 1
40000003 =	ISP's Name		= ChangeMe
40000004 =	Encapsulation	<2(PPPOE) 3(RFC 1483) 4(PPPoA) 5(ENET ENCAP)>	= 2

40000005 =	Multiplexing	<1(LLC-based) 2(VC-based)>	= 1	This value must be between 0-32.
40000006 =	VPI #		= 0	
40000007 =	VCI #		= 35	
40000008 =	Service Name	<Str>	= any	This value must be between 0-655355.
40000009 =	My Login	<Str>	= test@pqa	
40000010 =	My Password	<Str>	= 1234	
40000011 =	Single User Account	<0(No) 1(Yes)>	= 1	
40000012 =	IP Address Assignment	<0(Static) 1(Dynamic)>	= 1	
40000013 =	IP Address		= 0.0.0.0	
40000014 =	Remote IP address		= 0.0.0.0	
40000015 =	Remote IP subnet mask	This value must be between 0-32.	= 0	
40000016 =	ISP incoming protocol filter set 1		= 6	
40000017 =	ISP incoming protocol filter set 2		= 256	
40000018 =	ISP incoming protocol filter set 3		= 256	
40000019 =	ISP incoming protocol filter set 4		= 256	
40000020 =	ISP outgoing protocol filter set 1		= 256	
40000021 =	ISP outgoing protocol filter set 2		= 256	
40000022 =	ISP outgoing protocol filter set 3		= 256	
40000023 =	ISP outgoing protocol filter set 4		= 256	
40000024 =	ISP PPPoE idle timeout		= 0	
40000025 =	Route IP	<0(No) 1(Yes)>	= 1	
40000026 =	Bridge	<0(No) 1(Yes)>	= 0	
40000027 =	ATM QoS Type	<0(CBR) (1 (UBR))>	= 1	
40000028 =	Peak Cell Rate (PCR)		= 0	
40000029 =	Sustain Cell Rate (SCR)		= 0	
40000030 =	Maximum Burst Size(MBS)		= 0	

40000031=	RIP Direction	<0(None) 1(Both) 2(In Only) 3(Out Only)>	= 0
40000032=	RIP Version	<0(Rip-1) 1(Rip-2B) 2(Rip-2M)>	= 0
40000033=	Nailed-up Connection	<0(No) 1(Yes)>	= 0
/ MENU 12.1.1 IP STATIC ROUTE SETUP (SMT MENU 12.1.1)			
FIN	FN	PVA	INPUT
120101001 =	IP Static Route set #1, Name	<Str>	=
120101002 =	IP Static Route set #1, Active	<0(No) 1(Yes)>	= 0
120101003 =	IP Static Route set #1, Destination IP address		= 0.0.0.0
120101004 =	IP Static Route set #1, Destination IP subnetmask		= 0
120101005 =	IP Static Route set #1, Gateway		= 0.0.0.0
120101006 =	IP Static Route set #1, Metric		= 0
120101007 =	IP Static Route set #1, Private	<0(No) 1(Yes)>	= 0
/ MENU 12.1.2 IP STATIC ROUTE SETUP (SMT MENU 12.1.2)			
FIN	FN	PVA	INPUT
120102001 =	IP Static Route set #2, Name		=
120102002 =	IP Static Route set #2, Active	<0(No) 1(Yes)>	= 0
120102003 =	IP Static Route set #2, Destination IP address		= 0.0.0.0
120102004 =	IP Static Route set #2, Destination IP subnetmask		= 0
120102005 =	IP Static Route set #2, Gateway		= 0.0.0.0
120102006 =	IP Static Route set #2, Metric		= 0
120102007 =	IP Static Route set #2, Private	<0(No) 1(Yes)>	= 0
/ MENU 12.1.3 IP STATIC ROUTE SETUP (SMT MENU 12.1.3)			
FIN	FN	PVA	INPUT
120103001 =	IP Static Route set #3, Name	<Str>	=

This value must be between 0-8.

This value must be between 0-32.

120103002 =	IP Static Route set #3, Active	<0(No) 1(Yes)>	= 0
120103003 =	IP Static Route set #3, Destination IP address		= 0.0.0.0
120103004 =	IP Static Route set #3, Destination IP subnetmask		= 0
120103005 =	IP Static Route set #3, Gateway		= 0.0.0.0
120103006 =	IP Static Route set #3, Metric		= 0
120103007 =	IP Static Route set #3, Private	<0(No) 1(Yes)>	= 0
/ MENU 12.1.4 IP STATIC ROUTE SETUP (SMT MENU 12.1.4)			
FIN	FN	PVA	INPUT
120104001 =	IP Static Route set #4, Name	<Str>	=
120104002 =	IP Static Route set #4, Active	<0(No) 1(Yes)>	= 0
120104003 =	IP Static Route set #4, Destination IP address		= 0.0.0.0
120104004 =	IP Static Route set #4, Destination IP subnetmask		= 0
120104005 =	IP Static Route set #4, Gateway		= 0.0.0.0
120104006 =	IP Static Route set #4, Metric		= 0
120104007 =	IP Static Route set #4, Private	<0(No) 1(Yes)>	= 0
/ MENU 12.1.5 IP STATIC ROUTE SETUP (SMT MENU 12.1.5)			
FIN	FN	PVA	INPUT
120105001 =	IP Static Route set #5, Name	<Str>	=
120105002 =	IP Static Route set #5, Active	<0(No) 1(Yes)>	= 0
120105003 =	IP Static Route set #5, Destination IP address		= 0.0.0.0
120105004 =	IP Static Route set #5, Destination IP subnetmask		= 0
120105005 =	IP Static Route set #5, Gateway		= 0.0.0.0
120105006 =	IP Static Route set #5, Metric		= 0
120105007 =	IP Static Route set #5, Private	<0(No) 1(Yes)>	= 0

/ MENU 12.1.6 IP STATIC ROUTE SETUP (SMT MENU 12.1.6)			
FIN	FN	PVA	INPUT
120106001 =	IP Static Route set #6, Name	<Str>	=
120106002 =	IP Static Route set #6, Active	<0(No) 1(Yes)>	= 0
120106003 =	IP Static Route set #6, Destination IP address		= 0.0.0.0
120106004 =	IP Static Route set #6, Destination IP subnetmask		= 0
120106005 =	IP Static Route set #6, Gateway		= 0.0.0.0
120106006 =	IP Static Route set #6, Metric		= 0
120106007 =	IP Static Route set #6, Private	<0(No) 1(Yes)>	= 0
/ MENU 12.1.7 IP STATIC ROUTE SETUP (SMT MENU 12.1.7)			
FIN	FN	PVA	INPUT
120107001 =	IP Static Route set #7, Name	<Str>	=
120107002 =	IP Static Route set #7, Active	<0(No) 1(Yes)>	= 0
120107003 =	IP Static Route set #7, Destination IP address		= 0.0.0.0
120107004 =	IP Static Route set #7, Destination IP subnetmask		= 0
120107005 =	IP Static Route set #7, Gateway		= 0.0.0.0
120107006 =	IP Static Route set #7, Metric		= 0
120107007 =	IP Static Route set #7, Private	<0(No) 1(Yes)>	= 0
/ MENU 12.1.8 IP STATIC ROUTE SETUP (SMT MENU 12.1.8)			
FIN	FN	PVA	INPUT
120108001 =	IP Static Route set #8, Name	<Str>	=
120108002 =	IP Static Route set #8, Active	<0(No) 1(Yes)>	= 0
120108003 =	IP Static Route set #8, Destination IP address		= 0.0.0.0
120108004 =	IP Static Route set #8, Destination IP subnetmask		= 0

120108005 =	IP Static Route set #8, Gateway		= 0.0.0.0
120108006 =	IP Static Route set #8, Metric		= 0
120108007 =	IP Static Route set #8, Private	<0(No) 1(Yes)>	= 0

/ MENU 12.1.9 IP STATIC ROUTE SETUP (SMT MENU 12.1.9)

FIN	FN	PVA	INPUT
120109001 =	IP Static Route set #9, Name	<Str>	=
120109002 =	IP Static Route set #9, Active	<0(No) 1(Yes)>	= 0
120109003 =	IP Static Route set #9, Destination IP address		= 0.0.0.0
120109004 =	IP Static Route set #9, Destination IP subnetmask		= 0
120109005 =	IP Static Route set #9, Gateway		= 0.0.0.0
120109006 =	IP Static Route set #9, Metric		= 0
120109007 =	IP Static Route set #9, Private	<0(No) 1(Yes)>	= 0

/ MENU 12.1.10 IP STATIC ROUTE SETUP (SMT MENU 12.1.10)

FIN	FN	PVA	INPUT
120110001 =	IP Static Route set #10, Name		=
120110002 =	IP Static Route set #10, Active	<0(No) 1(Yes)>	= 0
120110003 =	IP Static Route set #10, Destination IP address		= 0.0.0.0
120110004 =	IP Static Route set #10, Destination IP subnetmask	<div style="border: 1px solid black; padding: 5px; display: inline-block;"> This value must be between 0-8. </div>	= 0
120110005 =	IP Static Route set #10, Gateway		= 0.0.0.0
120110006 =	IP Static Route set #10, Metric		= 0
120110007 =	IP Static Route set #10, Private	<0(No) 1(Yes)>	= 0

This value must be between 0-32.

/ MENU 12.1.11 IP STATIC ROUTE SETUP (SMT MENU 12.1.11)

FIN	FN	PVA	INPUT
120111001 =	IP Static Route set #11, Name	<Str>	=
120111002 =	IP Static Route set #11, Active	<0(No) 1(Yes)>	= 0

120111003 =	IP Static Route set #11, Destination IP address		= 0.0.0.0
120111004 =	IP Static Route set #11, Destination IP subnetmask		= 0
120111005 =	IP Static Route set #11, Gateway		= 0.0.0.0
120111006 =	IP Static Route set #11, Metric		= 0
120111007 =	IP Static Route set #11, Private	<0(No) 1(Yes)>	= 0
/ MENU 12.1.12 IP STATIC ROUTE SETUP (SMT MENU 12.1.12)			
FIN	FN	PVA	INPUT
120112001 =	IP Static Route set #12, Name	<Str>	=
120112002 =	IP Static Route set #12, Active	<0(No) 1(Yes)>	= 0
120112003 =	IP Static Route set #12, Destination IP address		= 0.0.0.0
120112004 =	IP Static Route set #12, Destination IP subnetmask		= 0
120112005 =	IP Static Route set #12, Gateway		= 0.0.0.0
120112006 =	IP Static Route set #12, Metric		= 0
120112007 =	IP Static Route set #12, Private	<0(No) 1(Yes)>	= 0
/ MENU 12.1.13 IP STATIC ROUTE SETUP (SMT MENU 12.1.13)			
FIN	FN	PVA	INPUT
120113001 =	IP Static Route set #13, Name	<Str>	=
120113002 =	IP Static Route set #13, Active	<0(No) 1(Yes)>	= 0
120113003 =	IP Static Route set #13, Destination IP address		= 0.0.0.0
120113004 =	IP Static Route set #13, Destination IP subnetmask		= 0
120113005 =	IP Static Route set #13, Gateway		= 0.0.0.0
120113006 =	IP Static Route set #13, Metric		= 0
120113007 =	IP Static Route set #13, Private	<0(No) 1(Yes)>	= 0
/ MENU 12.1.14 IP STATIC ROUTE SETUP (SMT MENU 12.1. 14)			

FIN	FN	PVA	INPUT
120114001 =	IP Static Route set #14, Name	<Str>	=
120114002 =	IP Static Route set #14, Active	<0(No) 1(Yes)>	= 0
120114003 =	IP Static Route set #14, Destination IP address		= 0.0.0.0
120114004 =	IP Static Route set #14, Destination IP subnetmask		= 0
120114005 =	IP Static Route set #14, Gateway		= 0.0.0.0
120114006 =	IP Static Route set #14, Metric		= 0
120114007 =	IP Static Route set #14, Private	<0(No) 1(Yes)>	= 0
/ MENU 12.1.15 IP STATIC ROUTE SETUP (SMT MENU 12.1. 15)			
FIN	FN	PVA	INPUT
120115001 =	IP Static Route set #15, Name	<Str>	=
120115002 =	IP Static Route set #15, Active	<0(No) 1(Yes)>	= 0
120115003 =	IP Static Route set #15, Destination IP address		= 0.0.0.0
120115004 =	IP Static Route set #15, Destination IP subnetmask		= 0
120115005 =	IP Static Route set #15, Gateway		= 0.0.0.0
120115006 =	IP Static Route set #15, Metric		= 0
120115007 =	IP Static Route set #15, Private	<0(No) 1(Yes)>	= 0
/ MENU 12.1.16 IP STATIC ROUTE SETUP (SMT MENU 12.1. 16)			
FIN	FN	PVA	INPUT
120116001 =	IP Static Route set #16, Name	<Str>	=
120116002 =	IP Static Route set #16, Active	<0(No) 1(Yes)>	= 0
120116003 =	IP Static Route set #16, Destination IP address		= 0.0.0.0
120116004 =	IP Static Route set #16, Destination IP subnetmask		= 0
120116005 =	IP Static Route set #16, Gateway		= 0.0.0.0

120116006 =	IP Static Route set #16, Metric		= 0
120116007 =	IP Static Route set #16, Private	<0(No) 1(Yes)>	= 0

/ MENU 15 SUA SERVER SETUP (SMT MENU 15)			
FIN	FN	PVA	INPUT
150000001 =	SUA Server IP address for default port		= 0.0.0.0
150000002 =	SUA Server #2 Active	<0(No) 1(Yes)>	= 0
150000003 =	SUA Server #2 Protocol	<0(All) 6(TCP) 17(UDP)>	= 0
150000004 =	SUA Server #2 Port Start		= 0
150000005 =	SUA Server #2 Port End		= 0
150000006 =	SUA Server #2 Local IP address		= 0.0.0.0
150000007 =	SUA Server #3 Active	<0(No) 1(Yes)>	= 0
150000008 =	SUA Server #3 Protocol	<0(All) 6(TCP) 17(UDP)>	= 0
150000009 =	SUA Server #3 Port Start		= 0
150000010 =	SUA Server #3 Port End		= 0
150000011 =	SUA Server #3 Local IP address		= 0.0.0.0
150000012 =	SUA Server #4 Active	<0(No) 1(Yes)>	= 0
150000013 =	SUA Server #4 Protocol	<0(All) 6(TCP) 17(UDP)>	= 0
150000014 =	SUA Server #4 Port Start		= 0
150000015 =	SUA Server #4 Port End		= 0
150000016 =	SUA Server #4 Local IP address		= 0.0.0.0
150000017 =	SUA Server #5 Active	<0(No) 1(Yes)>	= 0
150000018 =	SUA Server #5 Protocol	<0(All) 6(TCP) 17(UDP)>	= 0
150000019 =	SUA Server #5 Port Start		= 0
150000020 =	SUA Server #5 Port End		= 0

150000021 =	SUA Server #5 Local IP address		= 0.0.0.0
150000022 =	SUA Server #6 Active	<0(No) 1(Yes)> = 0	= 0
150000023 =	SUA Server #6 Protocol	<0(All) 6(TCP) 17(U DP)>	= 0
150000024 =	SUA Server #6 Port Start		= 0
150000025 =	SUA Server #6 Port End		= 0
150000026 =	SUA Server #6 Local IP address		= 0.0.0.0
150000027 =	SUA Server #7 Active	<0(No) 1(Yes)>	= 0
150000028 =	SUA Server #7 Protocol	<0(All) 6(TCP) 17(U DP)>	= 0.0.0.0
150000029 =	SUA Server #7 Port Start		= 0
150000030 =	SUA Server #7 Port End		= 0
150000031 =	SUA Server #7 Local IP address		= 0.0.0.0
150000032 =	SUA Server #8 Active	<0(No) 1(Yes)>	= 0
150000033 =	SUA Server #8 Protocol	<0(All) 6(TCP) 17(U DP)>	= 0
150000034 =	SUA Server #8 Port Start		= 0
150000035 =	SUA Server #8 Port End		= 0
150000036 =	SUA Server #8 Local IP address		= 0.0.0.0
150000037 =	SUA Server #9 Active	<0(No) 1(Yes)>	= 0
150000038 =	SUA Server #9 Protocol	<0(All) 6(TCP) 17(U DP)>	= 0
150000039 =	SUA Server #9 Port Start		= 0
150000040 =	SUA Server #9 Port End		= 0
150000041 =	SUA Server #9 Local IP address		= 0.0.0.0
150000042 =	SUA Server #10 Active	<0(No) 1(Yes)>	= 0
150000043 =	SUA Server #10 Protocol	<0(All) 6(TCP) 17(U DP)>	= 0
150000044 =	SUA Server #10 Port Start		= 0
150000045 =	SUA Server #10 Port End		= 0

150000046 =	SUA Server #10 Local IP address		= 0.0.0.0
150000047 =	SUA Server #11 Active	<0(No) 1(Yes)>	= 0
150000048 =	SUA Server #11 Protocol	<0(All) 6(TCP) 17(U DP)>	= 0
150000049 =	SUA Server #11 Port Start		= 0
150000050 =	SUA Server #11 Port End		= 0
150000051 =	SUA Server #11 Local IP address		= 0.0.0.0
150000052 =	SUA Server #12 Active	<0(No) 1(Yes)>	= 0
150000053 =	SUA Server #12 Protocol	<0(All) 6(TCP) 17(U DP)>	= 0
150000054 =	SUA Server #12 Port Start		= 0
150000055 =	SUA Server #12 Port End		= 0
150000056 =	SUA Server #12 Local IP address		= 0.0.0.0

/ MENU 21 FILTER SET #1 (SMT MENU 21)			
FIN	FN	PVA	INPUT
210100001 =	Filter Set 1, Name	<Str>	=

You may configure up to 12 filter sets with SMT menus; one with Internal SPTGEN.

/ MENU 21.1.1.1 FILTER SET #1, RULE #1 (SMT MENU 21.1.1.1)			
FIN	FN	PVA	INPUT
210101001 =	IP Filter Set 1,Rule 1 Type	<2(TCP/IP)>	= 2
210101002 =	IP Filter Set 1,Rule 1 Active	<0(No) 1(Yes)>	= 1
210101003 =	IP Filter Set 1,Rule 1 Protocol	This value must be between 0-255.	= 6
210101004 =	IP Filter Set 1,Rule 1 Dest IP address		= 0.0.0.0
210101005 =	IP Filter Set 1,Rule 1 Dest Subnet Mask		= 0
210101006 =	IP Filter Set 1,Rule 1 Dest Port	This value must be between 0-65535.	= 137
210101007 =	IP Filter Set 1,Rule 1 Dest Port Comp	<0(none) 1(equal) 2(not equal) 3(less) 4(greater)>	= 1
210101008 =	IP Filter Set 1,Rule 1 Src IP address		= 0.0.0.0

You may change this type using SMT menus only.

210101009 =	IP Filter Set 1,Rule 1 Src Subnet Mask		= 0
210101010 =	IP Filter Set 1,Rule 1 Src Port		= 0
210101011 =	IP Filter Set 1,Rule 1 Src Port Comp	<0(none) 1(equal) 2(not equal) 3(less) 4(greater)>	= 0
210101013 =	IP Filter Set 1,Rule 1 Act Match	<1(check next) 2(forward) 3(drop)>	= 3
210101014 =	IP Filter Set 1,Rule 1 Act Not Match	<1(check next) 2(forward) 3(drop)>	= 1
/ MENU 21.1.1.2 SET #1, RULE #2 (SMT MENU 21.1.1.2)			
FIN	FN	PVA	INPUT
210102001 =	IP Filter Set 1,Rule 2 Type	<2(TCP/IP)>	= 2
210102002 =	IP Filter Set 1,Rule 2 Active	<0(No) 1(Yes)>	= 1
210102003 =	IP Filter Set 1,Rule 2 Protocol		= 6
210102004 =	IP Filter Set 1,Rule 2 Dest IP address		= 0.0.0.0
210102005 =	IP Filter Set 1,Rule 2 Dest Subnet Mask		= 0
210102006 =	IP Filter Set 1,Rule 2 Dest Port		= 138
210102007 =	IP Filter Set 1,Rule 2 Dest Port Comp	<0(none) 1(equal) 2(not equal) 3(less) 4(greater)>	= 1
210102008 =	IP Filter Set 1,Rule 2 Src IP address		= 0.0.0.0
210102009 =	IP Filter Set 1,Rule 2 Src Subnet Mask		= 0
210102010 =	IP Filter Set 1,Rule 2 Src Port		= 0
210102011 =	IP Filter Set 1,Rule 2 Src Port Comp	<0(none) 1(equal) 2(not equal) 3(less) 4(greater)>	= 0

210102013 =	IP Filter Set 1,Rule 2 Act Match	<1(check next) 2(forward) 3(drop)>	= 3
210102014 =	IP Filter Set 1,Rule 2 Act Not Match	<1(check next) 2(forward) 3(drop)>	= 1
/ MENU 21.1.1.3 SET #1, RULE #3 (SMT MENU 21.1.1.3)			
FIN	FN	PVA	INPUT
210103001 =	IP Filter Set 1,Rule 3 Type	<2(TCP/IP)>	= 2
210103002 =	IP Filter Set 1,Rule 3 Active	<0(No) 1(Yes)>	= 1
210103003 =	IP Filter Set 1,Rule 3 Protocol		= 6
210103004 =	IP Filter Set 1,Rule 3 Dest IP address		= 0.0.0.0
210103005 =	IP Filter Set 1,Rule 3 Dest Subnet Mask		= 0
210103006 =	IP Filter Set 1,Rule 3 Dest Port		= 139
210103007 =	IP Filter Set 1,Rule 3 Dest Port Comp	<0(none) 1(equal) 2(not equal) 3(less) 4(greater)>	= 1
210103008 =	IP Filter Set 1,Rule 3 Src IP address		= 0.0.0.0
210103009 =	IP Filter Set 1,Rule 3 Src Subnet Mask		= 0
210103010 =	IP Filter Set 1,Rule 3 Src Port		= 0
210103011 =	IP Filter Set 1,Rule 3 Src Port Comp	<0(none) 1(equal) 2(not equal) 3(less) 4(greater)>	= 0
210103013 =	IP Filter Set 1,Rule 3 Act Match	<1(check next) 2(forward) 3(drop)>	= 3
210103014 =	IP Filter Set 1,Rule 3 Act Not Match	<1(check next) 2(forward) 3(drop)>	= 1
/ MENU 21.1.1.4 SET #1, RULE #4 (SMT MENU 21.1.1.4)			

FIN	FN	PVA	INPUT
210104001 =	IP Filter Set 1,Rule 4 Type	<2(TCP/IP)>	= 2
210104002 =	IP Filter Set 1,Rule 4 Active	<0(No) 1(Yes)>	= 1
210104003 =	IP Filter Set 1,Rule 4 Protocol		= 17
210104004 =	IP Filter Set 1,Rule 4 Dest IP address		= 0.0.0.0
210104005 =	IP Filter Set 1,Rule 4 Dest Subnet Mask		= 0
210104006 =	IP Filter Set 1,Rule 4 Dest Port		= 137
210104007 =	IP Filter Set 1,Rule 4 Dest Port Comp	<0(none) 1(equal) 2(not equal) 3(less) 4(greater)>	= 1
210104008 =	IP Filter Set 1,Rule 4 Src IP address		= 0.0.0.0
210104009 =	IP Filter Set 1,Rule 4 Src Subnet Mask		= 0
210104010 =	IP Filter Set 1,Rule 4 Src Port		= 0
210104011 =	IP Filter Set 1,Rule 4 Src Port Comp	<0(none) 1(equal) 2(not equal) 3(less) 4(greater)>	= 0
210104013 =	IP Filter Set 1,Rule 4 Act Match	<1(check next) 2(forward) 3(drop)>	= 3
210104014 =	IP Filter Set 1,Rule 4 Act Not Match	<1(check next) 2(forward) 3(drop)>	= 1
/ MENU 21.1.1.5 SET #1, RULE #5 (SMT MENU 21.1.1.5)			
FIN	FN	PVA	INPUT
210105001 =	IP Filter Set 1,Rule 5 Type	<2(TCP/IP)>	= 2
210105002 =	IP Filter Set 1,Rule 5 Active	<0(No) 1(Yes)>	= 1
210105003 =	IP Filter Set 1,Rule 5 Protocol		= 17
210105004 =	IP Filter Set 1,Rule 5 Dest IP address		= 0.0.0.0
210105005 =	IP Filter Set 1,Rule 5 Dest Subnet Mask		= 0

210105006 =	IP Filter Set 1,Rule 5 Dest Port		= 138
210105007 =	IP Filter Set 1,Rule 5 Dest Port Comp	<0(none) 1(equal) 2(not equal) 3(less) 4(greater)>	= 1
210105008 =	IP Filter Set 1,Rule 5 Src IP Address		= 0.0.0.0
210105009 =	IP Filter Set 1,Rule 5 Src Subnet Mask		= 0
210105010 =	IP Filter Set 1,Rule 5 Src Port		= 0
210105011 =	IP Filter Set 1,Rule 5 Src Port Comp	<0(none) 1(equal) 2(not equal) 3(less) 4(greater)>	= 0
210105013 =	IP Filter Set 1,Rule 5 Act Match	<1(check next) 2(forward) 3(drop)>	= 3
210105014 =	IP Filter Set 1,Rule 5 Act Not Match	<1(Check Next) 2(Forward) 3(Drop)>	= 1
/ MENU 21.1.1.6 SET #1, RULE #6 (SMT MENU 21.1.1.6)			
FIN	FN	PVA	INPUT
210106001 =	IP Filter Set 1,Rule 6 Type	<2(TCP/IP)>	= 2
210106002 =	IP Filter Set 1,Rule 6 Active	<0(No) 1(Yes)>	= 1
210106003 =	IP Filter Set 1,Rule 6 Protocol		= 17
210106004 =	IP Filter Set 1,Rule 6 Dest IP address		= 0.0.0.0
210106005 =	IP Filter Set 1,Rule 6 Dest Subnet Mask		= 0
210106006 =	IP Filter Set 1,Rule 6 Dest Port		= 139
210106007 =	IP Filter Set 1,Rule 6 Dest Port Comp	<0(none) 1(equal) 2(not equal) 3(less) 4(greater)>	= 1
210106008 =	IP Filter Set 1,Rule 6 Src IP address		= 0.0.0.0
210106009 =	IP Filter Set 1,Rule 6 Src Subnet Mask		= 0

210106010 =	IP Filter Set 1,Rule 6 Src Port		= 0
210106011 =	IP Filter Set 1,Rule 6 Src Port Comp	<0(none) 1(equal) 2(not equal) 3(less) 4(greater)>	= 0
210106013 =	IP Filter Set 1,Rule 6 Act Match	<1(check next) 2(forward) 3(drop)>	= 3
210106014 =	IP Filter Set 1,Rule 6 Act Not Match	<1(check next) 2(forward) 3(drop)>	= 2

/ MENU 21.1 FILTER SET #2, (SMT MENU 21.1)			
FIN	FN	PVA	INPUT
210200001 =	Filter Set 2, Nam	<Str>	= NetBIOS_WAN
/ MENU 21.1.2.1 FILTER SET #2, RULE #1 (SMT MENU 21.1.2.1)			
FIN	FN	PVA	INPUT
210201001 =	IP Filter Set 2, Rule 1 Type	<0(none) 2(TCP/IP)>	= 2
210201002 =	IP Filter Set 2, Rule 1 Active	<0(No) 1(Yes)>	= 1
210201003 =	IP Filter Set 2, Rule 1 Protocol		= 6
210201004 =	IP Filter Set 2, Rule 1 Dest IP address		= 0.0.0.0
210201005 =	IP Filter Set 2, Rule 1 Dest Subnet Mask		= 0
210201006 =	IP Filter Set 2, Rule 1 Dest Port		= 137
210201007 =	IP Filter Set 2, Rule 1 Dest Port Comp	<0(none) 1(equal) 2(not equal) 3(less) 4(greater)>	= 1
210201008 =	IP Filter Set 2, Rule 1 Src IP address		= 0.0.0.0
210201009 =	IP Filter Set 2, Rule 1 Src Subnet Mask		= 0
210201010 =	IP Filter Set 2, Rule 1 Src Port		= 0

210201011 =	IP Filter Set 2, Rule 1 Src Port Comp	<0(none) 1(equal) 2(not equal) 3(less) 4(greater)>	= 0
210201013 =	IP Filter Set 2, Rule 1 Act Match	<1(check next) 2(forward) 3(drop)>	= 3
210201014 =	IP Filter Set 2, Rule 1 Act Not Match	<1(check next) 2(forward) 3(drop)>	= 1
/ MENU 21.1.2.2 FILTER SET #2, RULE #2 (SMT MENU 21.1.2.2)			
FIN	FN	PVA	INPUT
210202001 =	IP Filter Set 2, Rule 2 Type	<0(none) 2(TCP/IP)>	= 2
210202002 =	IP Filter Set 2, Rule 2 Active	<0(No) 1(Yes)>	= 1
210202003 =	IP Filter Set 2, Rule 2 Protocol		= 6
210202004 =	IP Filter Set 2, Rule 2 Dest IP address		= 0.0.0.0
210202005 =	IP Filter Set 2, Rule 2 Dest Subnet Mask		= 0
210202006 =	IP Filter Set 2, Rule 2 Dest Port		= 138
210202007 =	IP Filter Set 2, Rule 2 Dest Port Comp	<0(none) 1(equal) 2(not equal) 3(less) 4(greater)>	= 1
210202008 =	IP Filter Set 2, Rule 2 Src IP address		= 0.0.0.0
210202009 =	IP Filter Set 2, Rule 2 Src Subnet Mask		= 0
210202010 =	IP Filter Set 2, Rule 2 Src Port		= 0
210202011 =	IP Filter Set 2, Rule 2 Src Port Comp	<0(none) 1(equal) 2(not equal) 3(less) 4(greater)>	= 0
210202013 =	IP Filter Set 2, Rule 2 Act Match	<1(check next) 2(forward) 3(drop)>	= 3

210202014 =	IP Filter Set 2, Rule 2 Act Not Match	<1(check next) 2(forward) 3(drop)>	= 1
/ MENU 21.1.2.3 FILTER SET #2, RULE #3 (SMT MENU 21.1.2.3)			
FIN	FN	PVA	INPUT
210203001 =	IP Filter Set 2, Rule 3 Type	<0(none) 2(TCP/IP)>	= 2
210203002 =	IP Filter Set 2, Rule 3 Active	<0(No) 1(Yes)>	= 1
210203003 =	IP Filter Set 2, Rule 3 Protocol		= 6
210203004 =	IP Filter Set 2, Rule 3 Dest IP address		= 0.0.0.0
210203005 =	IP Filter Set 2, Rule 3 Dest Subnet Mask		= 0
210203006 =	IP Filter Set 2, Rule 3 Dest Port		= 139
210203007 =	IP Filter Set 2, Rule 3 Dest Port Comp	<0(none) 1(equal) 2(not equal) 3(less) 4(greater)>	= 1
210203008 =	IP Filter Set 2, Rule 3 Src IP address		= 0.0.0.0
210203009 =	IP Filter Set 2, Rule 3 Src Subnet Mask		= 0
210203010 =	IP Filter Set 2, Rule 3 Src Port		= 0
210203011 =	IP Filter Set 2, Rule 3 Src Port Comp	<0(none) 1(equal) 2(not equal) 3(less) 4(greater)>	= 0
210203013 =	IP Filter Set 2, Rule 3 Act Match	<1(check next) 2(forward) 3(drop)>	= 3
210203014 =	IP Filter Set 2, Rule 3 Act Not Match	<1(check next) 2(forward) 3(drop)>	= 1
/ MENU 21.1.2.4 FILTER SET #2, RULE #4 (SMT MENU 21.1.2.4)			
FIN	FN	PVA	INPUT
210204001 =	IP Filter Set 2, Rule 4 Type	<0(none) 2(TCP/IP)>	= 2

210204002 =	IP Filter Set 2, Rule 4 Active		<0(No) 1(Yes)> = 1
210204003 =	IP Filter Set 2, Rule 4 Protocol		= 17
210204004 =	IP Filter Set 2, Rule 4 Dest IP address		= 0.0.0.0
210204005 =	IP Filter Set 2, Rule 4 Dest Subnet Mask		= 0
210204006 =	IP Filter Set 2, Rule 4 Dest Port		= 137
210204007 =	IP Filter Set 2, Rule 4 Dest Port Comp	<0(none) 1(equal) 2(not equal) 3(less) 4(greater)>	= 1
210204008 =	IP Filter Set 2, Rule 4 Src IP address		= 0.0.0.0
210204009 =	IP Filter Set 2, Rule 4 Src Subnet Mask		= 0
210204010 =	IP Filter Set 2, Rule 4 Src Port		= 0
210204011 =	IP Filter Set 2, Rule 4 Src Port Comp	<0(none) 1(equal) 2(not equal) 3(less) 4(greater)>	= 0
210204013 =	IP Filter Set 2, Rule 4 Act Match	<1(check next) 2(forward) 3(drop)>	= 3
210204014 =	IP Filter Set 2, Rule 4 Act Not Match	<1(check next) 2(forward) 3(drop)>	= 1
/ MENU 21.1.2.5 FILTER SET #2, RULE #5 (SMT MENU 21.1.2.5)			
FIN	FN	PVA	INPUT
210205001 =	IP Filter Set 2, Rule 5 Type	<0(none) 2(TCP/IP)>	= 2
210205002 =	IP Filter Set 2, Rule 5 Active	<0(No) 1(Yes)>	= 1
210205003 =	IP Filter Set 2, Rule 5 Protocol		= 17
210205004 =	IP Filter Set 2, Rule 5 Dest IP address		= 0.0.0.0
210205005 =	IP Filter Set 2, Rule 5 Dest Subnet Mask		= 0

210205006 =	IP Filter Set 2, Rule 5 Dest Port		= 138
210205007 =	IP Filter Set 2, Rule 5 Dest Port Comp	<0(none) 1(equal) 2(not equal) 3(less) 4(greater)>	= 1
210205008 =	IP Filter Set 2, Rule 5 Src IP address		= 0.0.0.0
210205009 =	IP Filter Set 2, Rule 5 Src Subnet Mask		= 0
210205010 =	IP Filter Set 2, Rule 5 Src Port		= 0
210205011 =	IP Filter Set 2, Rule 5 Src Port Comp	<0(none) 1(equal) 2(not equal) 3(less) 4(greater)>	= 0
210205013 =	IP Filter Set 2, Rule 5 Act Match	<1(check next) 2(forward) 3(drop)>	= 3
210205014 =	IP Filter Set 2, Rule 5 Act Not Match	<1(check next) 2(forward) 3(drop)>	= 1
/ MENU 21.1.2.6 FILTER SET #2, RULE #6 (SMT MENU 21.1.2.5)			
FIN	FN	PVA	INPUT
210206001 =	IP Filter Set 2, Rule 6 Type	<0(none) 2(TCP/IP)>	= 2
210206002 =	IP Filter Set 2, Rule 6 Active	<0(No) 1(Yes)>	= 1
210206003 =	IP Filter Set 2, Rule 6 Protocol		= 17
210206004 =	IP Filter Set 2, Rule 6 Dest IP address		= 0.0.0.0
210206005 =	IP Filter Set 2, Rule 6 Dest Subnet Mask		= 0
210206006 =	IP Filter Set 2, Rule 6 Dest Port		= 139
210206007 =	IP Filter Set 2, Rule 6 Dest Port Comp	<0(none) 1(equal) 2(not equal) 3(less) 4(greater)>	= 1
210206008 =	IP Filter Set 2, Rule 6 Src IP address		= 0.0.0.0

210206009 =	IP Filter Set 2, Rule 6 Src Subnet Mask		= 0
210206010 =	IP Filter Set 2, Rule 6 Src Port		= 0
210206011 =	IP Filter Set 2, Rule 6 Src Port Comp	<0(none) 1(equal) 2(not equal) 3(less) 4(greater)>	= 0
210206013 =	IP Filter Set 2,Rule 6 Act Match	<1(check next) 2(forward) 3(drop)>	= 3
210206014 =	IP Filter Set 2,Rule 6 Act Not Match	<1(check next) 2(forward) 3(drop)>	= 2

/ MENU 23.1 SYSTEM PASSWORD SETUP (SMT MENU 23.1)

FIN	FN	PVA	INPUT
230000000 =	System Password		= 1234

/ MENU 23.2 SYSTEM SECURITY: RADIUS SERVER (SMT MENU 23.2)

FIN	FN	PVA	INPUT
230200001 =	Authentication Server Configured	<0(No) 1(Yes)>	= 1
230200002 =	Authentication Server Active	<0(No) 1(Yes)>	= 1
230200003 =	Authentication Server IP Address		= 192.168.1.32
230200004 =	Authentication Server Port		= 1822
230200005 =	Authentication Server Shared Secret		= 1111111111111111 1111111111111111
230200006 =	Accounting Server Configured	<0(No) 1(Yes)>	= 1
230200007 =	Accounting Server Active	<0(No) 1(Yes)>	= 1
230200008 =	Accounting Server IP Address		= 192.168.1.44
230200009 =	Accounting Server Port		= 1823
230200010 =	Accounting Server Shared Secret		= 1234

/ MENU 23.4 SYSTEM SECURITY: IEEE802.1X (SMT MENU 23.4)

FIN	FN	PVA	INPUT
230400002 =	ReAuthentication Timer (in second)		= 555

230400003 =	Idle Timeout (in second)		= 999
230400004 =	Authentication Databases	<0(Local User Database Only) 1(RADIUS Only) 2(Local,RADIUS) 3(RADIUS,Local)>	= 1
/ MENU 24.11 REMOTE MANAGEMENT CONTROL (SMT MENU 24.11)			
FIN	FN	PVA	INPUT
241100001 =	TELNET Server Port		= 23
241100002 =	TELNET Server Access	<0(all) 1(none) 2(Lan) 3(Wan)>	= 0
241100003 =	TELNET Server Secured IP address		= 0.0.0.0
241100004 =	FTP Server Port		= 21
241100005 =	FTP Server Access	<0(all) 1(none) 2(Lan) 3(Wan)>	= 0
241100006 =	FTP Server Secured IP address		= 0.0.0.0
241100007 =	WEB Server Port		= 80
241100008 =	WEB Server Access	<0(all) 1(none) 2(Lan) 3(Wan)>	= 0
241100009 =	WEB Server Secured IP address		= 0.0.0.0

These values must be between 0-65535.

This value must be between 0-65535.

Command Examples

The following are example Internal SPTGEN screens associated with the Prestige's command interpreter commands.

/CI COMMAND (FOR ANNEX A): WAN ADSL OPENCMD			
FIN	FN	PVA	INPUT
990000001 =	ADSL OPMD	<0(glite) 1(t1.413) 2(gdmt) 3(multimode)>	= 3
/CI COMMAND (FOR ANNEX B): WAN ADSL OPENCMD			
FIN	FN	PVA	INPUT
990000001 =	ADSL OPMD	<0(etsi) 1(normal) 2(gdmt) 3(multimode)>	= 3

Appendix I

Setting up Your Computer's IP Address

All computers must have a 10M or 100M Ethernet adapter card and TCP/IP installed.

Windows 95/98/Me/NT/2000/XP, Macintosh OS 7 and later operating systems and all versions of UNIX/LINUX include the software components you need to install and use TCP/IP on your computer. Windows 3.1 requires the purchase of a third-party TCP/IP application package.

TCP/IP should already be installed on computers using Windows NT/2000/XP, Macintosh OS 7 and later operating systems.

After the appropriate TCP/IP components are installed, configure the TCP/IP settings in order to "communicate" with your network.

If you manually assign IP information instead of using dynamic assignment, make sure that your computers have IP addresses that place them in the same subnet as the Prestige's LAN port.

Windows 95/98/Me

Click **Start, Settings, Control Panel** and double-click the **Network** icon to open the **Network** window.

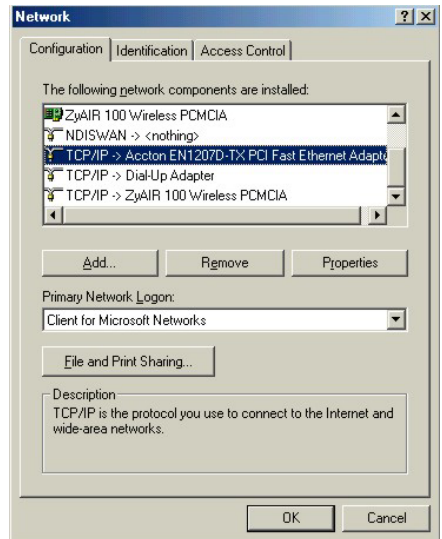

Installing Components

The **Network** window **Configuration** tab displays a list of installed components. You need a network adapter, the TCP/IP protocol and Client for Microsoft Networks.

If you need the adapter:

- a. In the **Network** window, click **Add**.
- b. Select **Adapter** and then click **Add**.
- c. Select the manufacturer and model of your network adapter and then click **OK**.

If you need TCP/IP:

- a. In the **Network** window, click **Add**.
- b. Select **Protocol** and then click **Add**.
- c. Select **Microsoft** from the list of **manufacturers**.
- d. Select **TCP/IP** from the list of network protocols and then click **OK**.

If you need Client for Microsoft Networks:

- a. Click **Add**.
- b. Select **Client** and then click **Add**.
- c. Select **Microsoft** from the list of manufacturers.
- d. Select **Client for Microsoft Networks** from the list of network clients and then click **OK**.
- e. Restart your computer so the changes you made take effect.

Configuring IP Address

1. In the **Network** window **Configuration** tab, select your network adapter's TCP/IP entry and click **Properties**.

2. Click the **IP Address** tab.
 - If your IP address is dynamic, select **Obtain an IP address automatically**.
 - If you have a static IP address, select **Specify an IP address** and type your information into the **IP Address** and **Subnet Mask** fields.

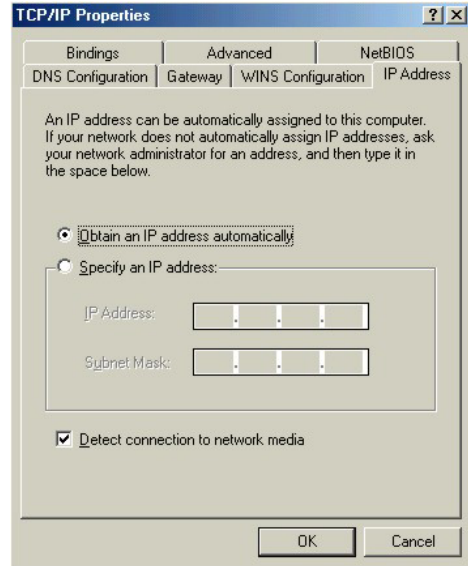

3. Click the **DNS Configuration** tab.
 - If you do not know your DNS information, select **Disable DNS**.
 - If you know your DNS information, select **Enable DNS** and type the information in the fields below (you may not need to fill them all in).

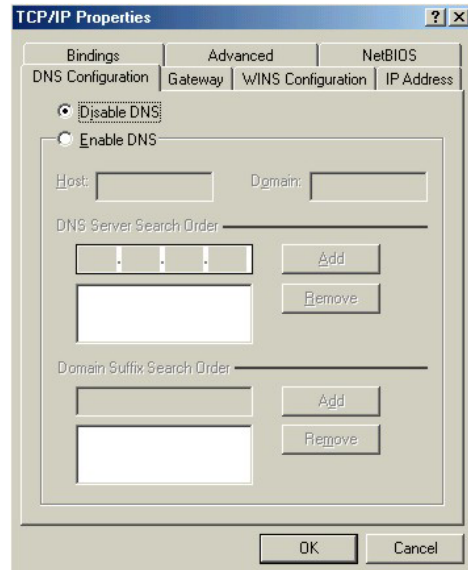

4. Click the **Gateway** tab.
 - If you do not know your gateway's IP address, remove previously installed gateways.
 - If you have a gateway IP address, type it in the **New gateway field** and click **Add**.

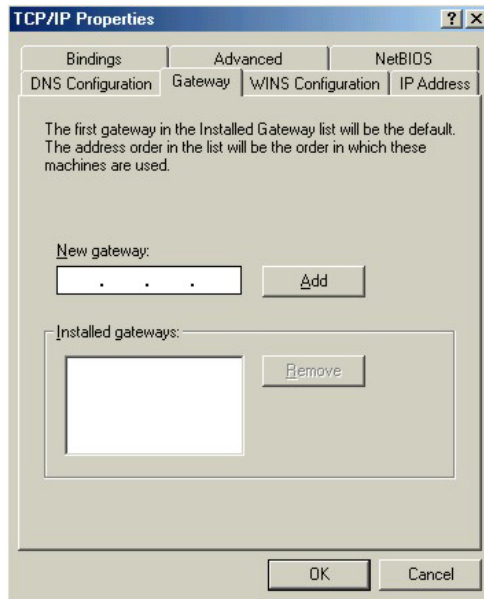

5. Click **OK** to save and close the **TCP/IP Properties** window.
6. Click **OK** to close the **Network** window. Insert the Windows CD if prompted.
7. Turn on your Prestige and restart your computer when prompted.

Verifying Settings

1. Click **Start** and then **Run**.
2. In the **Run** window, type "winipcfg" and then click **OK** to open the **IP Configuration** window.
3. Select your network adapter. You should see your computer's IP address, subnet mask and default gateway.

Windows 2000/NT/XP

1. For Windows XP, click **start, Control Panel**. In Windows 2000/NT, click **Start, Settings, Control Panel**.



2. For Windows XP, click **Network Connections**. For Windows 2000/NT, click **Network and Dial-up Connections**.

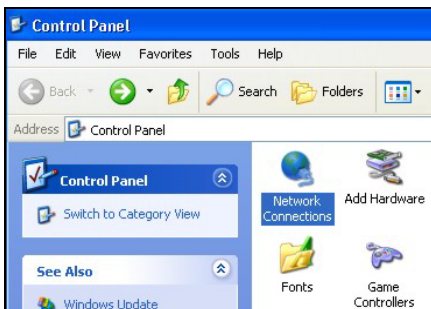

3. Right-click **Local Area Connection** and then click **Properties**.

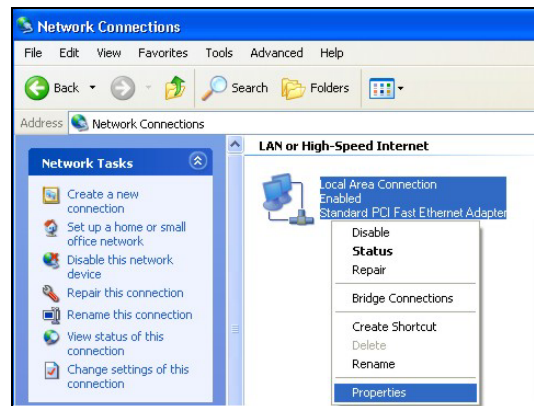

4. Select **Internet Protocol (TCP/IP)** (under the **General** tab in Win XP) and click **Properties**.

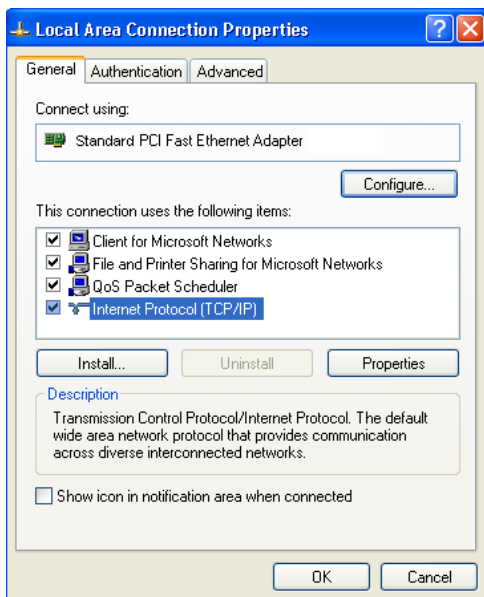

5. The **Internet Protocol TCP/IP Properties** window opens (the **General** tab in Windows XP).

-If you have a dynamic IP address click **Obtain an IP address automatically**.

-If you have a static IP address click **Use the following IP Address** and fill in the **IP address**, **Subnet mask**, and **Default gateway** fields.

Click **Advanced**.

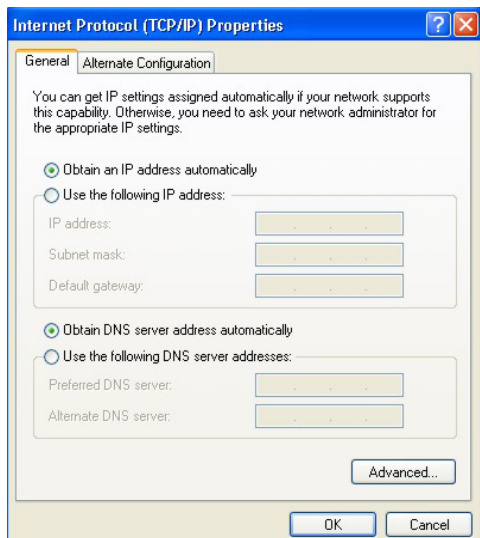

6. -If you do not know your gateway's IP address, remove any previously installed gateways in the **IP Settings** tab and click **OK**.

Do one or more of the following if you want to configure additional IP addresses:

-In the **IP Settings** tab, in IP addresses, click **Add**.

-In **TCP/IP Address**, type an IP address in **IP address** and a subnet mask in **Subnet mask**, and then click **Add**.

-Repeat the above two steps for each IP address you want to add.

-Configure additional default gateways in the **IP Settings** tab by clicking **Add** in **Default gateways**.

-In **TCP/IP Gateway Address**, type the IP address of the default gateway in **Gateway**. To manually configure a default metric (the number of transmission hops), clear the **Automatic metric** check box and type a metric in **Metric**.

-Click **Add**.

-Repeat the previous three steps for each default gateway you want to add.

-Click **OK** when finished.

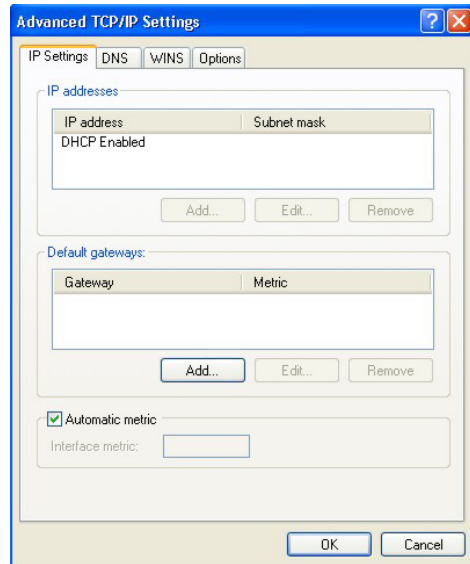

7. In the **Internet Protocol TCP/IP Properties** window (the **General tab** in Windows XP):

-Click **Obtain DNS server address automatically** if you do not know your DNS server IP address(es).

-If you know your DNS server IP address(es), click **Use the following DNS server addresses**, and type them in the **Preferred DNS server** and **Alternate DNS server** fields.

If you have previously configured DNS servers, click **Advanced** and then the **DNS** tab to order them.

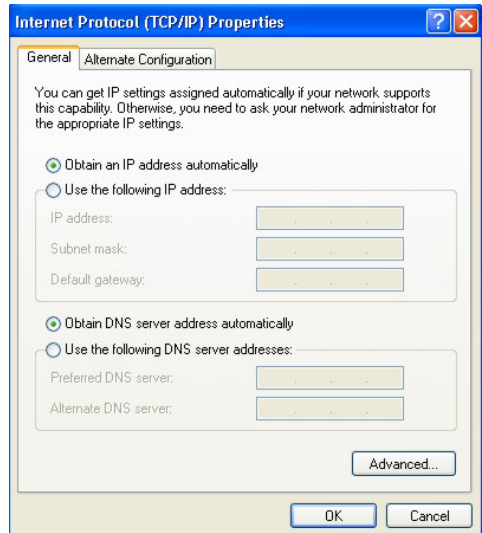

8. Click **OK** to close the **Internet Protocol (TCP/IP) Properties** window.
9. Click **OK** to close the **Local Area Connection Properties** window.
10. Turn on your Prestige and restart your computer (if prompted).

Verifying Settings

1. Click **Start, All Programs, Accessories** and then **Command Prompt**.
2. In the **Command Prompt** window, type "ipconfig" and then press [ENTER]. You can also open **Network Connections**, right-click a network connection, click **Status** and then click the **Support** tab.

Macintosh OS 8/9

1. Click the **Apple** menu, **Control Panel** and double-click **TCP/IP** to open the **TCP/IP Control Panel**.

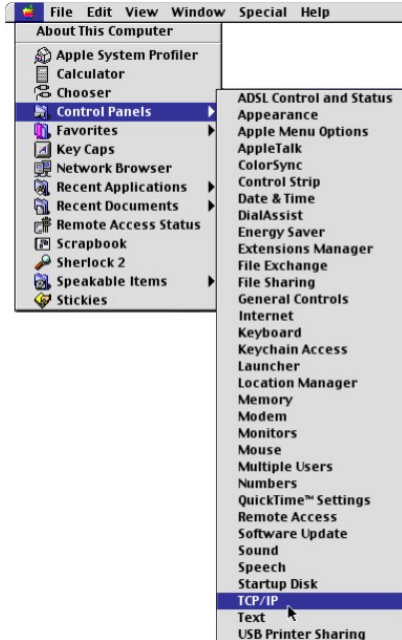

2. Select **Ethernet built-in** from the **Connect via** list.

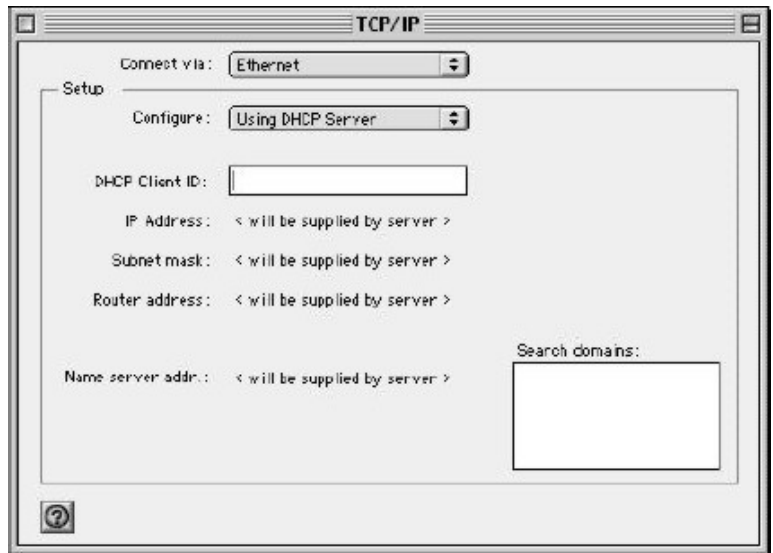

3. For dynamically assigned settings, select **Using DHCP Server** from the **Configure:** list.
4. For statically assigned settings, do the following:
 - From the **Configure** box, select **Manually**.
 - Type your IP address in the **IP Address** box.
 - Type your subnet mask in the **Subnet mask** box.
 - Type the IP address of your Prestige in the **Router address** box.
5. Close the **TCP/IP Control Panel**.
6. Click **Save** if prompted, to save changes to your configuration.
7. Turn on your Prestige and restart your computer (if prompted).

Verifying Settings

Check your TCP/IP properties in the **TCP/IP Control Panel** window.

Macintosh OS X

1. Click the **Apple** menu, and click **System Preferences** to open the **System Preferences** window.

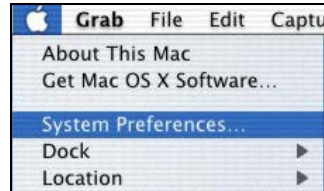

2. Click **Network** in the icon bar.
 - Select **Automatic** from the **Location** list.
 - Select **Built-in Ethernet** from the **Show** list.
 - Click the **TCP/IP** tab.

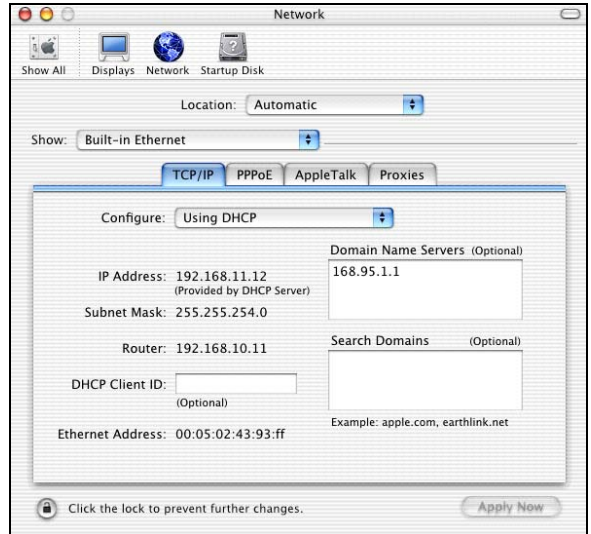

3. For dynamically assigned settings, select **Using DHCP** from the **Configure** list.
4. For statically assigned settings, do the following:
 - From the **Configure** box, select **Manually**.
 - Type your IP address in the **IP Address** box.
 - Type your subnet mask in the **Subnet mask** box.
 - Type the IP address of your Prestige in the **Router address** box.
5. Click **Apply Now** and close the window.
6. Turn on your Prestige and restart your computer (if prompted).

Verifying Settings

Check your TCP/IP properties in the **Network** window.

Appendix J

Splitters and Microfilters

This appendix tells you how to install a POTS splitter or a telephone microfilter.

Connecting a POTS Splitter

When you use the Full Rate (G.dmt) ADSL standard, you can use a POTS (Plain Old Telephone Service) splitter to separate the telephone and ADSL signals. This allows simultaneous Internet access and telephone service on the same line. A splitter also eliminates the destructive interference conditions caused by telephone sets.

Install the POTS splitter at the point where the telephone line enters your residence, as shown in the following figure.

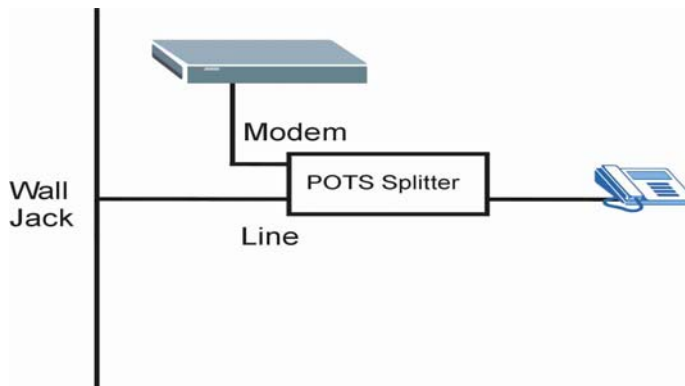

Diagram J-1 Connecting a POTS Splitter

- Step 1.** Connect the side labeled “Phone” to your telephone.
- Step 2.** Connect the side labeled “Modem” to your Prestige.
- Step 3.** Connect the side labeled “Line” to the telephone wall jack.

Telephone Microfilters

Telephone voice transmissions take place in the lower frequency range, 0 - 4KHz, while ADSL transmissions take place in the higher bandwidth range, above 4KHz. A microfilter acts as a low-pass filter, for your telephone, to ensure that ADSL transmissions do not interfere with your telephone voice transmissions. The use of a telephone microfilter is optional.

- Step 1.** Connect a phone cable from the wall jack to the single jack end of the Y- Connector.
- Step 2.** Connect a cable from the double jack end of the Y-Connector to the “wall side” of the microfilter.
- Step 3.** Connect another cable from the double jack end of the Y-Connector to the Prestige.
- Step 4.** Connect the “phone side” of the microfilter to your telephone as shown in the following figure.

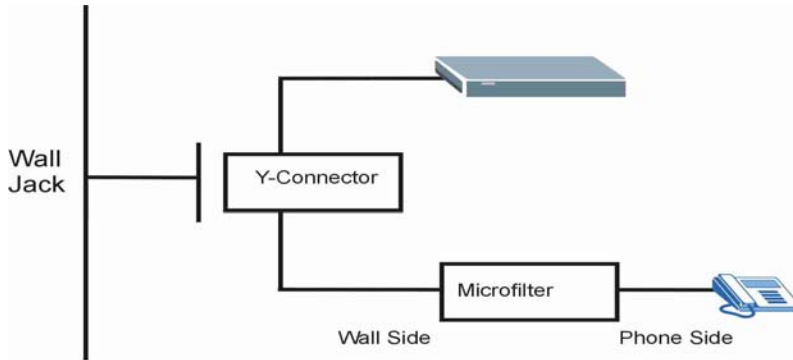

Diagram J-2 Connecting a Microfilter

Prestige With ISDN

This section relates to people who use their Prestige with ADSL over ISDN (digital telephone service) only. The following is an example installation for the Prestige with ISDN.

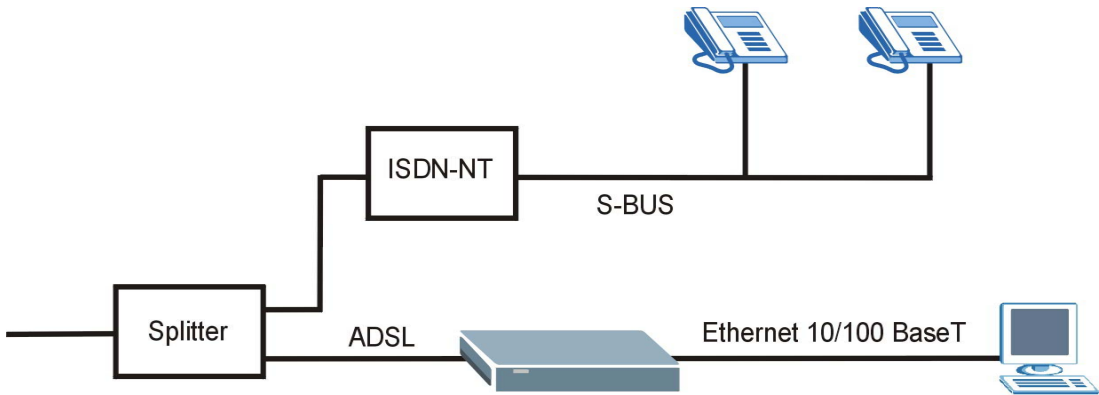

Diagram J-3 Prestige with ISDN

Appendix K

Log Descriptions

This appendix provides descriptions of example log messages¹.

Chart K-1 System Maintenance Logs

LOG MESSAGE	DESCRIPTION
Time calibration is successful	The router has adjusted its time based on information from the time server.
Time calibration failed	The router failed to get information from the time server.
DHCP client gets %s	A DHCP client got a new IP address from the DHCP server.
DHCP client IP expired	A DHCP client's IP address has expired.
DHCP server assigns %s	The DHCP server assigned an IP address to a client.
SMT Login Successfully	Someone has logged on to the router's SMT interface.
SMT Login Fail	Someone has failed to log on to the router's SMT interface.
WEB Login Successfully	Someone has logged on to the router's web configurator interface.
WEB Login Fail	Someone has failed to log on to the router's web configurator interface.
TELNET Login Successfully	Someone has logged on to the router via telnet.
TELNET Login Fail	Someone has failed to log on to the router via telnet.
FTP Login Successfully	Someone has logged on to the router via ftp.
FTP Login Fail	Someone has failed to log on to the router via ftp.

¹ At the time of writing, the Prestige did not support the generation of all of the logs shown here.

Chart K-2 UPnP Logs

LOG MESSAGE	DESCRIPTION
UPnP pass through Firewall	UPnP packets can pass through the firewall.

For the content filtering logs “(Destination)” means the destination IP address or domain name.

Chart K-3 Content Filtering Logs

MESSAGE	NOTE	DESCRIPTION
(Destination) Keyword Blocking	Web Block	The Prestige blocked access to an address or domain name that had a forbidden keyword.
(Destination) Contains ActiveX	Web Block	The Prestige blocked access to an IP address or domain name that contains ActiveX because the content filter is set to forbid ActiveX.
(Destination) Contains Java applet	Web Block	The Prestige blocked access to an IP address or domain name that contains a Java applet because the content filter is set to forbid Java applets.
(Destination) Contains cookie	Web Block	The Prestige blocked access to an IP address or domain name that contains a cookie because the content filter is set to forbid cookies.
(Destination) Proxy mode detected	Web Block	The Prestige blocked access to an IP address or domain name that contains a proxy because the content filter is set to forbid proxies.
(Destination)	Web Forward	The Prestige allowed access to an address or domain name when content filtering was turned off according to its schedule.

The attack logs may include the protocol (Protocol) of the packet (for example TCP or UDP) that triggered the log.

Chart K-4 Attack Logs

LOG MESSAGE	DESCRIPTION
attack (Protocol)	The firewall detected an attack. The log may also display the protocol (for example TCP or UDP).
land Protocol)	The firewall detected a land attack. The log may also display the protocol (for example TCP or UDP).
icmp echo ICMP (type:%d, code:%d)	The firewall detected an ICMP echo attack. See the section on ICMP messages for type and code details.
syn flood TCP	The firewall detected a TCP syn flood attack.
ports scan TCP	The firewall detected a TCP port scan attack.
teardrop (Protocol)	The firewall detected a teardrop attack.
illegal command TCP	The firewall detected a TCP SMTP illegal command attack.
NetBIOS TCP	The firewall detected a TCP NetBIOS attack.
ip spoofing - no routing entry (Protocol)	The firewall detected an IP spoofing attack while the Prestige did not have a default route. The log may also display the protocol (for example TCP or UDP).
vulnerability ICMP (type:%d, code:%d)	The firewall detected an ICMP vulnerability attack; see the section on ICMP messages for type and code details.
traceroute ICMP (type:%d, code:%d)	The firewall detected an ICMP traceroute attack; see the section on ICMP messages for type and code details.

Access logs may include the following information:

- (Protocol) is the protocol of the packet (for example TCP or UDP) that triggered the log.
- (Direction) is the direction in which the packet was traveling (for example LAN to WAN or WAN to LAN)
- (Rule) is the number of the firewall rule that caused the log.

Chart K-5 Access Logs

LOG MESSAGE	DESCRIPTION
Firewall default policy (Protocol, Direction)	Access matched the default policy and the Prestige blocked or forwarded it according to the configuration of the default firewall policy.
Firewall rule match (Protocol, Direction, Rule)	Access matched a firewall rule and the Prestige blocked or forwarded it according to the rule's configuration.
Firewall rule NOT match: (Protocol, Direction, Rule)	Access did not match a firewall rule and the Prestige logged it.
dest port (Protocol, Direction)	Access did not match a firewall rule's destination port and the Prestige logged it.
src port (Protocol, Direction)	Access did not match a firewall rule's source port and the Prestige logged it.
dest IP (Protocol, Direction)	Access did not match a firewall rule's destination IP address and the Prestige logged it.
src IP (Protocol, Direction)	Access did not match a firewall rule's source IP address and the Prestige logged it.
protocol (Protocol, Direction)	Access did not match a firewall rule's protocol and the Prestige logged it.
Triangle route packet forwarded (Protocol)	The firewall allowed a triangle route session to pass through.
ICMP Source Quench	The Prestige sent or received an ICMP source quench packet to tell a host to slow down data transmission.
ICMP Time Exceed	The Prestige sent or received an ICMP Time Exceed packet because a packet with zero Time To Live (TTL) was dropped.
ICMP Destination Unreachable	The Prestige sent or received an ICMP Destination Unreachable packet when a packet was dropped because the target port was not open.
Packet without a NAT table entry blocked (Protocol)	The router blocked a packet that did not have a corresponding NAT table entry.

Chart K-5 Access Logs

LOG MESSAGE	DESCRIPTION
Out of order TCP handshake packet blocked (Protocol)	The router blocked a TCP handshake packet that came out of the proper order
Unsupported/out-of-order ICMP (Protocol)	The Prestige generates this log after it drops an ICMP packet due to one of the following two reasons: 1. The Prestige does not support the ICMP packet's protocol. 2. The ICMP packet is an echo reply for which there was no corresponding echo request.
Router reply ICMP packet	The router sent an ICMP response packet. This packet automatically bypasses the firewall.
Remote access denied	The router blocked a remote access attempt.

Chart K-6 TCP Reset Logs

LOG MESSAGE	DESCRIPTION
Firewall sent TCP reset packets	The firewall sent out TCP reset packets.

Chart K-7 ICMP Notes

TYPE	CODE	DESCRIPTION
0		Echo Reply
	0	Echo reply message
3		Destination Unreachable
	0	Net unreachable
	1	Host unreachable
	2	Protocol unreachable
	3	Port unreachable

Chart K-7 ICMP Notes

TYPE	CODE	DESCRIPTION
	4	A packet that needed fragmentation was dropped because it was set to Don't Fragment (DF)
	5	Source route failed
4		Source Quench
	0	A gateway may discard internet datagrams if it does not have the buffer space needed to queue the datagrams for output to the next network on the route to the destination network.
5		Redirect
	0	Redirect datagrams for the Network
	1	Redirect datagrams for the Host
	2	Redirect datagrams for the Type of Service and Network
	3	Redirect datagrams for the Type of Service and Host
8		Echo
	0	Echo message
11		Time Exceeded
	0	Time to live exceeded in transit
	1	Fragment reassembly time exceeded
12		Parameter Problem
	0	Pointer indicates the error
13		Timestamp
	0	Timestamp request message
14		Timestamp Reply
	0	Timestamp reply message
15		Information Request
	0	Information request message
16		Information Reply

Chart K-7 ICMP Notes

TYPE	CODE	DESCRIPTION
	0	Information reply message

VPN/IPSec logs

To view the IPSec and IKE connection log, type 3 in menu 27 and press [ENTER] to display the IPSec log as shown next. The following figure shows a typical log from the initiator of a VPN connection.

```

Index:      Date/Time:      Log:
-----
001  01 Jan 08:02:22  Send Main Mode request to <192.168.100.101>
002  01 Jan 08:02:22  Send:<SA>
003  01 Jan 08:02:22  Recv:<SA>
004  01 Jan 08:02:24  Send:<KE><NONCE>
005  01 Jan 08:02:24  Recv:<KE><NONCE>
006  01 Jan 08:02:26  Send:<ID><HASH>
007  01 Jan 08:02:26  Recv:<ID><HASH>
008  01 Jan 08:02:26  Phase 1 IKE SA process done
009  01 Jan 08:02:26  Start Phase 2: Quick Mode
010  01 Jan 08:02:26  Send:<HASH><SA><NONCE><ID><ID>
011  01 Jan 08:02:26  Recv:<HASH><SA><NONCE><ID><ID>
012  01 Jan 08:02:26  Send:<HASH>
Clear IPSec Log (y/n):

```

Diagram K-1 Example VPN Initiator IPSec Log

VPN Responder IPSec Log

The following figure shows a typical log from the VPN connection peer.

```

Index:      Date/Time:      Log:
-----
001      01 Jan 08:08:07      Recv Main Mode request from <192.168.100.100>
002      01 Jan 08:08:07      Recv:<SA>
003      01 Jan 08:08:08      Send:<SA>
004      01 Jan 08:08:08      Recv:<KE><NONCE>
005      01 Jan 08:08:10      Send:<KE><NONCE>
006      01 Jan 08:08:10      Recv:<ID><HASH>
007      01 Jan 08:08:10      Send:<ID><HASH>
008      01 Jan 08:08:10      Phase 1 IKE SA process done
009      01 Jan 08:08:10      Recv:<HASH><SA><NONCE><ID><ID>
010      01 Jan 08:08:10      Start Phase 2: Quick Mode
011      01 Jan 08:08:10      Send:<HASH><SA><NONCE><ID><ID>
012      01 Jan 08:08:10      Recv:<HASH>
Clear IPsec Log (y/n):

```

Diagram K-2 Example VPN Responder IPsec Log

This menu is useful for troubleshooting. A log index number, the date and time the log was created and a log message are displayed.

Double exclamation marks (!!) denote an error or warning message.

The following table shows sample log messages during IKE key exchange.

Chart K-8 Sample IKE Key Exchange Logs

LOG MESSAGE	DESCRIPTION
Send <Symbol> Mode request to <IP> Send <Symbol> Mode request to <IP>	The Prestige has started negotiation with the peer.
Recv <Symbol> Mode request from <IP> Recv <Symbol> Mode request from <IP>	The Prestige has received an IKE negotiation request from the peer.
Recv:<Symbol>	IKE uses the ISAKMP protocol (refer to RFC2408 – ISAKMP) to transmit data. Each ISAKMP packet contains payloads of different types that show in the log – see <i>Chart J-10</i> .
Phase 1 IKE SA process done	Phase 1 negotiation is finished.

Chart K-8 Sample IKE Key Exchange Logs

LOG MESSAGE	DESCRIPTION
Start Phase 2: Quick Mode	Phase 2 negotiation is begins by using Quick Mode.
!! IKE Negotiation is in process	The Prestige has begun negotiation with the peer for the connection already, but the IKE key exchange has not finished yet.
!! Duplicate requests with the same cookie	The Prestige has received multiple requests from the same peer but it is still processing the first IKE packet from that peer.
!! No proposal chosen	The parameters configured for Phase 1 or Phase 2 negotiations don't match. Please check all protocols and settings for these phases. For example, one party may be using 3DES encryption, but the other party is using DES encryption, so the connection will fail.
!! Verifying Local ID failed !! Verifying Remote ID failed	During IKE Phase 2 negotiation, both parties exchange policy details, including local and remote IP address ranges. If these ranges differ, then the connection fails.
!! Local / remote IPs of incoming request conflict with rule <#d>	If the security gateway is "0.0.0.0", the Prestige will use the peer's "Local Addr" as its "Remote Addr". If this IP (range) conflicts with a previously configured rule then the connection is not allowed.
!! Invalid IP <IP start>/<IP end>	The peer's "Local IP Addr" range is invalid.
!! Remote IP <IP start> / <IP end> conflicts	If the security gateway is "0.0.0.0", the Prestige will use the peer's "Local Addr" as its "Remote Addr". If a peer's "Local Addr" range conflicts with other connections, then the Prestige will not accept VPN connection requests from this peer.
!! Active connection allowed exceeded	The Prestige limits the number of simultaneous Phase 2 SA negotiations. The IKE key exchange process fails if this limit is exceeded.
!! IKE Packet Retransmit	The Prestige did not receive a response from the peer and so retransmits the last packet sent.
!! Failed to send IKE Packet	The Prestige cannot send IKE packets due to a network error.

Chart K-8 Sample IKE Key Exchange Logs

LOG MESSAGE	DESCRIPTION
!! Too many errors! Deleting SA	The Prestige deletes an SA when too many errors occur.
!! ID type mismatch	The ID type of an incoming packet does not match the local's peer ID type.
!! ID content mismatch	The ID content of an incoming packet does not match the local's peer ID content.
!! No known phase 1 ID type found	The ID type of an incoming packet does not match any known ID type.
vs. My Remote <IP address>	The IP address type or IP address of an incoming packet does not match the peer IP address type or IP address configured on the local router. The log displays this router's configured remote IP address type or IP address that the incoming packet did not match.
vs. My Local <IP address>	The IP address type or IP address of an incoming packet does not match the peer IP address type or IP address configured on the local router. The log displays this router's configured local IP address type or IP address that the incoming packet did not match.
-> <symbol>	The router sent a payload type of IKE packet.

The following table shows sample log messages during packet transmission.

Chart K-9 Sample IPsec Logs During Packet Transmission

LOG MESSAGE	DESCRIPTION
!! WAN IP changed to <IP>	If the Prestige's WAN IP changes, all configured "My IP Addr" are changed to b "0.0.0.0". If this field is configured as 0.0.0.0, then the Prestige will use the current Prestige WAN IP address (static or dynamic) to set up the VPN tunnel.
!! Cannot find outbound SA for rule <%d>	The packet matches the rule index number (#d), but Phase 1 or Phase 2 negotiation for outbound (from the VPN initiator) traffic is not finished yet.

Chart K-9 Sample IPSec Logs During Packet Transmission

LOG MESSAGE	DESCRIPTION
!! Discard REPLAY packet	If the Prestige receives a packet with the wrong sequence number it will discard it.
!! Inbound packet authentication failed	The authentication configuration settings are incorrect. Please check them.
!! Inbound packet decryption failed	The decryption configuration settings are incorrect. Please check them.
Rule <#d> idle time out, disconnect	If an SA has no packets transmitted for a period of time (configurable via CI command), the Prestige drops the connection.

The following table shows RFC-2408 ISAKMP payload types that the log displays. Please refer to the RFC for detailed information on each type.

Chart K-10 RFC-2408 ISAKMP Payload Types

LOG DISPLAY	PAYLOAD TYPE
SA	Security Association
PROP	Proposal
TRANS	Transform
KE	Key Exchange
ID	Identification
CER	Certificate
CER_REQ	Certificate Request
HASH	Hash
SIG	Signature
NONCE	Nonce
NOTFY	Notification
DEL	Delete
VID	Vendor ID

Appendix L

Index

8

802.1x Configuration 6-10

A

Action for Matched Packets 13-12
 Active 25-11, 25-13
 Address Assignment 5-2
 Ad-hoc Configuration C-2
 ADSL Transmission Rate Standards 1-5
 ADSL, what is it? xxxiv
 AIM 13-8
 Allocated Budget 25-12
 Alternative Subnet Mask Notation B-3
 Antenna
 Directional D-2
 Omni-directional D-1
 Types D-1
 Antenna gain D-1
 Antenna Gain D-1
 Antenna Selection and Positioning D-1
 Antennae Positioning D-2
 Antennas
 Setup D-2
 Application-level Firewalls 11-1
 Applications for the Prestige 1-8
 AT command 38-1
 ATM QoS Type 7-2
 Attack Alert 12-2, 12-3, 12-4
 Attack Types 11-6
 Authen 25-11
 Authentication 25-11, 29-4, 29-5
 Authentication Protocol
 Outgoing 29-5
 auto-negotiation 1-4

B

Backup 38-2
 Bandwidth Borrowing 21-7
 Bandwidth Class 21-1
 Bandwidth Filter 21-1, 21-15
 Bandwidth Management 1-4, 21-1
 Bandwidth Management Statistics 21-17
 Bandwidth Manager Class Configuration 21-13
 Bandwidth Manager Class Setup 21-11
 Bandwidth Manager Monitor 21-18
 Bandwidth Manager Summary 21-9
 Basic Rate Interface 1-3
 Basic Service Set C-2
 BGP 13-8
 Blocking Time 12-3
 BOOTP 13-8
 Borrow bandwidth from parent class 21-15
 BRI 1-3
 Bridging 26-2, 31-1
 Ether Address 31-4
 Ethernet 31-1
 Ethernet Addr Timeout 31-3
 Remote Node 31-1
 Static Route Setup 31-3
 Brute-force Attack, 11-6
 BSS See Basic Service Set
 Budget Management 39-2, 39-3
 BW Budget 21-15

C

Call Filtering 34-1
 Call Filters
 Built-In 34-1
 User-Defined 34-1
 Call Scheduling 42-1
 Maximum Number of Schedule Sets 42-1

PPPoE..... 42-3
 Precedence..... 42-1
 Precedence Example..... See precedence
 caller ID 25-6
 Calling Line Indication 25-6
 CDR 37-7
 CDR (Call Detail Record)..... 37-6
 Channel ID..... 27-2
 CHAP 25-11, 29-4
 Class A..... B-1
 Class A Network..... B-7
 Class B..... B-1
 Class B Network..... B-7
 Class C..... B-1
 Class D..... B-1
 Class Name..... 21-14
 Classes of IP Addresses..... B-1
 Collision..... 37-3
 Command Interpreter Mode..... 39-1
 Community..... 35-2
 Computer Name..... 24-1
 Conditions that prevent TFTP and FTP from
 working over WAN..... 38-4
 Configuration..... 3-11, 22-6
 Configuring IP Address..... I-2
 Connect on Demand 7-3, 7-7
 Console Configuration..... 23-1
 Content Filtering..... 15-1
 Categories..... 15-1
 Exempt Computers..... 15-4
 Keywords 15-1, 15-3
 Copyright..... ii
 Cost Of Transmission 25-15, 29-7, 30-3
 Country Code..... 37-4
 CPU Load..... 37-3
 CU-SEEME 13-8
 Custom Ports
 Creating/Editing 14-2
 Introduction 14-1
 Customer Support..... v
 Customized Services..... 14-2

D

data compression 1-3
 Data decryption 6-4
 Data encryption 6-4
 Data Filtering..... 34-1
 Data Link Connection..... 25-7
 Default Policy Log 13-6
 Denial of Service 11-2, 11-3, 12-2, 12-3, 33-1
 Denial of Services Thresholds..... 12-4
 Destination Address 13-3, 13-12
 Device Filter rules 34-15
 DHCP 1-6, 3-11, 5-2, 5-3, 9-1, 22-6, 37-5
 Diagnostic Tools..... 37-1
 Diagnostics Capabilities 1-7
 Dial Backup Configuration..... 25-1
 Dial-On-Demand..... 1-4
 Digital Subscriber Line Access Multiplexer..... 1-8
 Direct Sequence Spread Spectrum C-1
 Distribution System..... C-2
 DNS 13-8, 26-3
 DNS Configuration..... 9-1
 DNS Server Address..... 5-1
 Domain Name..... 5-2, 8-7
 Domain Name System..... 5-1
 DoS
 Basics 11-3
 Types..... 11-4
 DoS (Denial of Service) 1-2
 DS..... See Distribution System
 DSL (Digital Subscriber Line) xxxiv
 DSL LED
 Troubleshooting A-1
 DSL, What Is It?..... xxxiv
 DSLAM..... See Digital Subscriber Line Access
 Multiplexer
 DSS-1..... 25-5
 DSSS See Direct Sequence Spread Spectrum
 Dynamic DNS 1-5, 9-1, 24-2
 DYNDNS Wildcard..... 9-1

E	
EAP	6-8
EAP Authentication Sequence	6-9
ECHO.....	8-7
Edit IP	25-12
E-mail	
Log Example.....	20-6
Encapsulation.....	1-6, 3-1, 28-5, 29-2
ENET ENCAP	3-1
PPP over Ethernet	3-1
PPPoA.....	3-1
RFC 1483.....	3-2
Encryption.....	16-1
Error Log.....	37-5
Error/Information Messages	
Sample	37-6
ESS.....	See Extended Service Set
ESS ID	6-1
Ethernet Encapsulation	8-6
Ethernet Setup	26-1
Ethernet Traffic.....	34-19
European (DSS1) ISDN Setup Menus	25-5
Example Internal SPTGEN Screens.....	H-1
Extended Service Set	C-2
F	
Factory LAN Defaults.....	5-2
Fairness-based Scheduler	21-4
FCC.....	iii
FHSS ...See Frequency-Hopping Spread Spectrum	
Filename Conventions.....	38-1
Filter.....	25-18, 26-1
Applying Filters	34-18
Ethernet traffic	34-19
Ethernet Traffic.....	34-19
Filter Rules	34-7
Filter Structure	34-4
Generic Filter Rule	34-13
Remote Node	29-8
Remote Node Filter.....	29-8
Remote Node Filters	34-19
Sample.....	34-17
SUA	34-15
TCP/IP Filter Rule.....	34-9
Filter Configuration	34-1
Filter Log	37-7, 37-8
Filter Rule	34-10
Filter Rule Process.....	34-3
Filter Rule Setup	34-8
Filter Rules Summary	
Sample	34-18
Filter Set	
Class	34-9
Filter Set Configuration	34-4, 34-6
Filtering	34-1, 34-9
Filtering Process	
Outgoing Packets.....	34-2
Finger.....	8-7
FINGER.....	13-8
Firewall.....	1-2
Access Methods.....	33-1
Address Type.....	13-13
Alerts	12-2
Configuration.....	12-1
Connection Direction.....	13-3
Creating/Editing Rules	13-10
Custom Ports	See Custom Ports
Custom Rule Example	14-3
Customized Services Config	14-4
Enabling	12-1
Firewall Vs Filters	11-12
Guidelines For Enhancing Security	11-11
Introduction	11-2
LAN to WAN Rules	13-3
Logs.....	13-5
Policies	13-1
Remote Management.....	12-1, 33-1
Rule Checklist	13-1
Rule Logic	13-1
Rule Precedence	13-5
Rule Security Ramifications.....	13-2
Services	13-7

IP Policies 41-5

IP Policy Routing (IPPR)..... 1-6, 28-1

 Applying an IP Policy..... 41-5

 Ethernet IP Policies..... 41-5

 Gateway..... 41-5

IP Pool Setup..... 3-12

IP Ports..... 43-9, 43-10

IP Protocol 41-4

IP Routing Policy (IPPR)..... 41-1

 Benefits..... 41-1

 Cost Savings..... 41-1

 Criteria..... 41-1

 Load Sharing..... 41-1

 Setup..... 41-2

IP Routing Policy Setup..... 41-3

IP Spoofing 11-4, 11-7

IP Static Route 30-1

IP Static Route Setup 30-2

IP Subnetting..... B-1

IPSec 16-1

IPSec Algorithms 16-4

IPSec and NAT 16-5

IPSec Architecture 16-4

IPSec Setup..... 43-1, 43-6

IPSec standard..... 1-1

IPSEC TUNNEL..... 13-8

IPSec VPN Capability..... 1-1

IRC..... 13-8

ISDN J-2

ISDN Connection Setup..... 7-5

ISDN Dial Backup 25-1

ISDN Dial Backup Configuration..... 25-4

ISDN Dial In Setup..... 7-8

ISDN Interface..... 1-3

ISDN Remote Node Profile 25-10

ISDN Setup..... 25-8

ISDN-DCP..... 7-1

K

Key Fields For Configuring Rules 13-2

L

LAN..... 37-3

LAN Configuration..... 5-4

LAN Interface

 Troubleshooting..... A-2

LAN Setup..... 5-1, 26-1

LAN TCP/IP 5-2

LAN to WAN Rules 13-3

LAN/DMZ Interface..... 1-5

LAND..... 11-4, 11-6

Link type..... 37-2

LLC-based Multiplexing..... 29-10

Local Network

 Rule Summary..... 13-5

Log and Trace..... 37-6

Log Descriptions..... K-1

Log Facility..... 37-7

Logging Option..... 34-11, 34-14

Login..... 29-4

Logs 20-1

Loop-back Test..... 25-8

M

MAC 6-6

MAC address 31-4

MAC Address Filter 27-3

MAC Address Filter Action..... 6-8, 27-3

MAC Address Filtering 6-6

MAC Filter 6-6

Macintosh OS 8/9 I-9

Macintosh OS X I-10

Main Menu 23-5

Management Information Base (MIB)..... 35-2

Maximize Bandwidth Usage..... 21-4, 21-11

Maximum Burst Size (MBS) 7-3

Max-incomplete High..... 12-3

Max-incomplete Low..... 12-3

Media Access Control..... 31-1

Media Access Control Address..... 6-6

Message Logging..... 37-5

Metric..... 7-2, 25-15, 29-7, 30-3

PPP Multilink.....	1-3	Remote Management Setup	40-1
PPPoA	29-2	Remote Node	29-1, 37-2
PPPoE	E-1	Network Layer.....	29-5
PPPoE Support (RFC2516).....	1-4	Remote Node Profile.....	29-3
PPTP	8-7, 13-9	Remote Node Setup.....	29-1, 29-2
PPTP TUNNEL	13-9	Remote Node Filter.....	25-18
Precedence	41-1, 41-4	Remote Node Index Number	37-2
Prestige Firewall Application.....	11-3	Remote Node Setup	29-1
Primary DNS.....	5-2	Remote Node Traffic	34-20
Priority	21-15	Required fields.....	23-4
Priority-based Scheduler.....	21-4	Resetting the Prestige	2-3
Private	25-15, 29-7, 30-4	Restore Configuration.....	38-7
Private IP Addresses	3-5	REXEC	13-9
Proportional Bandwidth Allocation	21-2	RF signals	C-1
Protocol.....	34-10	RFC-1483	29-2
Protocol Filter Rules	34-15	RFC-2364	29-2, 29-3
Protocol Support	1-6	RIP.....	25-16, 26-3, 29-7. See Routing Information Protocol
Q			
Quality of Service	41-1	RLOGIN	13-9
R			
Radiation Pattern.....	D-1	Root Class.....	21-11
RADIUS.....	6-8	Route IP Setup.....	28-4
Shared Secret Key.....	6-9	Routing Information Protocol.....	5-3
RADIUS Message Types	6-9	Direction.....	5-3
RAS.....	37-4, 41-2	Version	5-3
Rate		Routing Policy	41-1
Receiving.....	37-2	RTELNET	13-9
Transmission.....	37-2	RTS Threshold.....	6-2, 27-2
RCMD.....	13-9	RTS/CTS	6-2
Read Me First.....	xxxii	RTSP.....	13-9
REAL AUDIO	13-9	Rule Summary	13-5, 14-6
Related Documentation.....	xxxii	Rules	13-1, 13-4
Rem Node Name.....	25-11, 25-13	Checklist.....	13-1
Remote DHCP Server.....	26-3	Creating Custom.....	13-1
Remote Management		Key Fields	13-2
Firewall.....	12-1, 33-1	LAN to WAN	13-3
Troubleshooting.....	A-5	Logic.....	13-1
Remote Management and NAT	18-2	Predefined Services	13-7
Remote Management Limitations	18-1, 40-2	Source and Destination Addresses	13-12
		Summary	13-5
		Timeout	13-13

S

SA Monitor	44-1	SPTGEN Screens	H-1
Sample IP Addresses	29-8	SQL-NET	13-9
Saving the State	11-7	SSH.....	13-9
Schedule Sets		Stac data compression	1-3
Duration.....	42-2	Start-Up	
Scheduler	21-4, 21-11	Troubleshooting	A-1
script	25-16	Stateful Inspection.....	1-2, 11-1, 11-2, 11-7, 11-8
Secondary DNS	5-2	Prestige.....	11-9
Security Association	44-1	Process	11-8
Security In General.....	11-11	Static Route Setup.....	30-1
Security Ramifications.....	13-2	Static Routing Topology.....	30-1
Server.. ⁸⁻⁵ , 10-2, 32-3, 32-4, 32-5, 32-8, 32-9, 32-10, 32-13, 32-14, 39-5		STRM.....	13-9
Service	iv, 13-2	SUA	1-8, 8-6, 8-7
Service Type	A-3, 14-3	SUA (Single User Account) ..	See NAT. See NAT
Services.....	8-6, 8-7	SUA Server.....	8-9
setup a schedule.....	42-2	Sub-class Layers.....	21-11
SFTP	13-9	Subnet Mask ...	3-4, 5-3, 13-13, 25-15, 26-3, 29-6, 30-3, 37-4
SITE Map Screen.....	2-3	Subnet Masks	B-2
SMT General Setup	24-1	Subnetting.....	B-2
SMT Interface.....	23-3	Supporting Disk.....	xxxii
SMT Introduction	23-1	Sustained Cell Rate (SCR)	7-3
SMT Menu Overview	23-2	SYN Flood.....	11-4, 11-5
SMT System Password.....	23-6	SYN-ACK	11-5
SMTP	8-7, 13-9	Syntax Conventions.....	xxxiii
SMTP Error Messages.....	20-5	Syslog.....	14-3, 37-6
Smurf	11-6	Syslog Configuration.....	14-5
SNMP	8-7, 13-9	Syslog IP Address	37-7
Community.....	35-3	Syslog Server.....	37-6
Configuration.....	35-2	System	
Get.....	35-2	Console Port Speed	37-5
Manager.....	35-2	Diagnostic	37-8
MIBs.....	35-2	Log and Trace	37-5
Trap	35-2	Syslog and Accounting	37-6
Trusted Host.....	35-3	System Information.....	37-4
SNMP-TRAPS.....	13-9	System Status	37-1
Source & Destination Addresses	13-12	System Information	37-3
Source Address	13-3, 13-11	System Information & Diagnosis	37-1
Source-Based Routing	41-1	System Maintenance.20-4, 37-1, 37-3, 38-2, 38-5, 38-13, 38-14, 39-1, 39-2, 39-4, 39-5	
Splitters.....	J-1	System Management Terminal	23-3

System Parameter Table Generator.....	45-1
System Status	37-2
System Timeout	18-2, 40-3

T

TACACS.....	13-10
TCP Maximum Incomplete.....	12-3
TCP Security	11-10
TCP/IP	11-3, 11-4, 18-2, 25-14, 34-15, 37-9
Teardrop.....	11-4
Telephone Microfilters.....	J-1
Telnet	18-2
TELNET	13-10
Telnet Configuration	18-2
Text File Format	45-1
TFTP and FTP Over WAN	18-1
TFTP and FTP over WAN Will Not Work	
When.....	38-4
TFTP File Transfer.....	38-12
TFTP Restrictions	18-1, 38-4
Three-Way Handshake.....	11-5
Threshold Values	12-2
Time and Date Setting.....	39-4, 39-5
Time Server.....	10-2
Time Zone.....	10-1, 39-5
Time/Date	10-1
Timeout.....	13-13, 13-14, 25-3, 25-12
TOS (Type of Service).....	41-1
Trace Records	37-5
Traceroute	11-7
Traffic Redirect.....	1-2, 7-13, 7-14, 7-15
Setup	25-3
Traffic Shaping	7-3
Traffic Shaping Example	7-4
Transmission Rates	1-1
Transport Mode.....	16-5
Troubleshooting	A-1
Tunnel Mode.....	16-5
Type of Service	41-1, 41-3, 41-4, 41-5

U

UDP/ICMP Security	11-10
Universal Plug and Play.....	19-1
Application.....	19-1
Security issues	19-1
Universal Plug and Play (UPnP).....	1-4
Universal Plug and Play Forum	19-2
UNIX Syslog	37-5, 37-7
UNIX syslog parameters.....	37-6
Upload Firmware	38-10
Uploading	2-4
UPnP.....	See Universal Plug and Play
Upper Layer Protocols.....	11-10, 11-11
User Name	9-2
User Profiles	6-12, 36-5

V

VC-based Multiplexing	29-2
VCI	7-2
VDOLIVE	13-10
Virtual Channel.....	F-1
Virtual Circuit.....	F-1
Virtual Circuit ID.....	7-2
Virtual Circuit Topology	F-1
Virtual Path.....	F-1
Virtual Private Network.....	1-1
VPI.....	7-2
VPI & VCI.....	3-2
VPN	
Encapsulation	16-5
Key Management	16-4
VPN Application	1-9
VPN Applications.....	16-2
VPN Overview.....	16-1
VPN Setup	43-1
VPN/IPSec.....	43-1
VPN/IPSec logs.....	K-7

W

WAN Backup	7-13
WAN Backup	25-1

